



DR-880

Dr. Rhythm

Owner's Manual

Thank you, and congratulations on your choice of the BOSS DR-880 Dr. Rhythm.

Before using this unit, carefully read the sections entitled:

- **USING THE UNIT SAFELY** (page 2–3)
- **IMPORTANT NOTES** (page 4–5)

These sections provide important information concerning the proper operation of the unit.

Additionally, in order to feel assured that you have gained a good grasp of every feature provided by your new unit, the owner's manual should be read in its entirety. The manual should be saved and kept on hand as a convenient reference.

■ Printing Conventions in This Manual

- Text or numerals enclosed in square brackets [] indicate buttons.

[EFFECT] EFFECT button

[PATTERN] PATTERN button

- Reference such as (p. **) indicate pages in this manual to which you can refer.

Copyright © 2004 BOSS CORPORATION

All rights reserved. No part of this publication may be reproduced in any form without the written permission of BOSS CORPORATION.

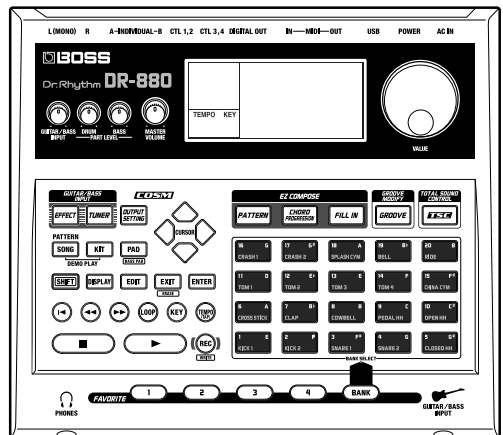

USING THE UNIT SAFELY

INSTRUCTIONS FOR THE PREVENTION OF FIRE, ELECTRIC SHOCK, OR INJURY TO PERSONS

About ⚠ WARNING and ⚠ CAUTION Notices

⚠ WARNING	Used for instructions intended to alert the user to the risk of death or severe injury should the unit be used improperly.
⚠ CAUTION	Used for instructions intended to alert the user to the risk of injury or material damage should the unit be used improperly. * Material damage refers to damage or other adverse effects caused with respect to the home and all its furnishings, as well to domestic animals or pets.

About the Symbols

	The ⚠ symbol alerts the user to important instructions or warnings. The specific meaning of the symbol is determined by the design contained within the triangle. In the case of the symbol at left, it is used for general cautions, warnings, or alerts to danger.
	The ⚡ symbol alerts the user to items that must never be carried out (are forbidden). The specific thing that must not be done is indicated by the design contained within the circle. In the case of the symbol at left, it means that the unit must never be disassembled.
	The ⚡ symbol alerts the user to things that must be carried out. The specific thing that must be done is indicated by the design contained within the circle. In the case of the symbol at left, it means that the power-cord plug must be unplugged from the outlet.

ALWAYS OBSERVE THE FOLLOWING

WARNING

- Before using this unit, make sure to read the instructions below, and the Owner's Manual.
- Do not open (or modify in any way) the unit or its AC adaptor.
- Do not attempt to repair the unit, or replace parts within it (except when this manual provides specific instructions directing you to do so). Refer all servicing to your retailer, the nearest Roland Service Center, or an authorized Roland distributor, as listed on the "Information" sheet.
- Never use or store the unit in places that are:
 - Subject to temperature extremes (e.g., direct sunlight in an enclosed vehicle, near a heating duct, on top of heat-generating equipment); or are
 - Damp (e.g., baths, washrooms, on wet floors); or are
 - Humid; or are
 - Exposed to rain; or are
 - Dusty; or are
 - Subject to high levels of vibration.
- Make sure you always have the unit placed so it is level and sure to remain stable. Never place it on stands that could wobble, or on inclined surfaces.

WARNING

- Be sure to use only the AC adaptor supplied with the unit. Also, make sure the line voltage at the installation matches the input voltage specified on the AC adaptor's body. Other AC adaptors may use a different polarity, or be designed for a different voltage, so their use could result in damage, malfunction, or electric shock.
- Do not excessively twist or bend the power cord, nor place heavy objects on it. Doing so can damage the cord, producing severed elements and short circuits. Damaged cords are fire and shock hazards!
- This unit, either alone or in combination with an amplifier and headphones or speakers, may be capable of producing sound levels that could cause permanent hearing loss. Do not operate for a long period of time at a high volume level, or at a level that is uncomfortable. If you experience any hearing loss or ringing in the ears, you should immediately stop using the unit, and consult an audiologist.
- Do not allow any objects (e.g., flammable material, coins, pins); or liquids of any kind (water, soft drinks, etc.) to penetrate the unit.

WARNING

- Immediately turn the power off, remove the AC adaptor from the outlet, and request servicing by your retailer, the nearest Roland Service Center, or an authorized Roland distributor, as listed on the “Information” sheet when:
 - The AC adaptor, the power-supply cord, or the plug has been damaged; or
 - If smoke or unusual odor occurs
 - Objects have fallen into, or liquid has been spilled onto the unit; or
 - The unit has been exposed to rain (or otherwise has become wet); or
 - The unit does not appear to operate normally or exhibits a marked change in performance.
- In households with small children, an adult should provide supervision until the child is capable of following all the rules essential for the safe operation of the unit.
- Protect the unit from strong impact. (Do not drop it!)
- Do not force the unit’s power-supply cord to share an outlet with an unreasonable number of other devices. Be especially careful when using extension cords—the total power used by all devices you have connected to the extension cord’s outlet must never exceed the power rating (watts/amperes) for the extension cord. Excessive loads can cause the insulation on the cord to heat up and eventually melt through.
- Before using the unit in a foreign country, consult with your retailer, the nearest Roland Service Center, or an authorized Roland distributor, as listed on the “Information” sheet.
- **DO NOT** play a CD-ROM disc on a conventional audio CD player. The resulting sound may be of a level that could cause permanent hearing loss. Damage to speakers or other system components may result.

CAUTION

- The unit and the AC adaptor should be located so their location or position does not interfere with their proper ventilation.
- Always grasp only the plug on the AC adaptor cord when plugging into, or unplugging from, an outlet or this unit.
- At regular intervals, you should unplug the AC adaptor and clean it by using a dry cloth to wipe all dust and other accumulations away from its prongs. Also, disconnect the power plug from the power outlet whenever the unit is to remain unused for an extended period of time. Any accumulation of dust between the power plug and the power outlet can result in poor insulation and lead to fire.
- Try to prevent cords and cables from becoming entangled. Also, all cords and cables should be placed so they are out of the reach of children.
- Never climb on top of, nor place heavy objects on the unit.
- Never handle the AC adaptor or its plugs with wet hands when plugging into, or unplugging from, an outlet or this unit.
- Before moving the unit, disconnect the AC adaptor and all cords coming from external devices.
- Before cleaning the unit, turn off the power and unplug the AC adaptor from the outlet.
- Whenever you suspect the possibility of lightning in your area, disconnect the AC adaptor from the outlet.

IMPORTANT NOTES

In addition to the items listed under “USING THE UNIT SAFELY” on page 2–3, please read and observe the following:

Power Supply

- Do not connect this unit to same electrical outlet that is being used by an electrical appliance that is controlled by an inverter (such as a refrigerator, washing machine, microwave oven, or air conditioner), or that contains a motor. Depending on the way in which the electrical appliance is used, power supply noise may cause this unit to malfunction or may produce audible noise. If it is not practical to use a separate electrical outlet, connect a power supply noise filter between this unit and the electrical outlet.
- The AC adaptor will begin to generate heat after long hours of consecutive use. This is normal, and is not a cause for concern.
- Before connecting this unit to other devices, turn off the power to all units. This will help prevent malfunctions and/or damage to speakers or other devices.

Placement

- Using the unit near power amplifiers (or other equipment containing large power transformers) may induce hum. To alleviate the problem, change the orientation of this unit; or move it farther away from the source of interference.
- This device may interfere with radio and television reception. Do not use this device in the vicinity of such receivers.
- Noise may be produced if wireless communications devices, such as cell phones, are operated in the vicinity of this unit. Such noise could occur when receiving or initiating a call, or while conversing. Should you experience such problems, you should relocate such wireless devices so they are at a greater distance from this unit, or switch them off.

- Do not expose the unit to direct sunlight, place it near devices that radiate heat, leave it inside an enclosed vehicle, or otherwise subject it to temperature extremes. Excessive heat can deform or discolor the unit.
- When moved from one location to another where the temperature and/or humidity is very different, water droplets (condensation) may form inside the unit. Damage or malfunction may result if you attempt to use the unit in this condition. Therefore, before using the unit, you must allow it to stand for several hours, until the condensation has completely evaporated.

Maintenance

- For everyday cleaning wipe the unit with a soft, dry cloth or one that has been slightly dampened with water. To remove stubborn dirt, use a cloth impregnated with a mild, non-abrasive detergent. Afterwards, be sure to wipe the unit thoroughly with a soft, dry cloth.
- Never use benzene, thinners, alcohol or solvents of any kind, to avoid the possibility of discoloration and/or deformation.

Repairs and Data

- Please be aware that all data contained in the unit’s memory may be lost when the unit is sent for repairs. Important data should always be backed up in another MIDI device (e.g., a sequencer), computer, or written down on paper (when possible). During repairs, due care is taken to avoid the loss of data. However, in certain cases (such as when circuitry related to memory itself is out of order), we regret that it may not be possible to restore the data, and Roland assumes no liability concerning such loss of data.

Additional Precautions

- Please be aware that the contents of memory can be irretrievably lost as a result of a malfunction, or the improper operation of the unit. To protect yourself against the risk of losing important data, we recommend that you periodically save a backup copy of important data you have stored in the unit's memory in another MIDI device (e.g., a sequencer) or computer.
- Unfortunately, it may be impossible to restore the contents of data that was stored in the unit's memory once it has been lost. Roland Corporation assumes no liability concerning such loss of data.
- Use a reasonable amount of care when using the unit's buttons, sliders, or other controls; and when using its jacks and connectors. Rough handling can lead to malfunctions.
- Never strike or apply strong pressure to the display.
- When connecting / disconnecting all cables, grasp the connector itself—never pull on the cable. This way you will avoid causing shorts, or damage to the cable's internal elements.
- To avoid disturbing your neighbors, try to keep the unit's volume at reasonable levels. You may prefer to use headphones, so you do not need to be concerned about those around you (especially when it is late at night).
- When you need to transport the unit, package it in the box (including padding) that it came in, if possible. Otherwise, you will need to use equivalent packaging materials.
- Use only the specified expression pedal (EV-5; sold separately). By connecting any other expression pedals, you risk causing malfunction and/or damage to the unit.
- Use a cable from Roland to make the connection. If using some other make of connection cable, please note the following precautions.
 - Some connection cables contain resistors. Do not use cables that incorporate resistors for connecting to this unit. The use of such cables can cause the sound level to be extremely low, or impossible to hear. For information on cable specifications, contact the manufacturer of the cable.
- The explanations in this manual include illustrations that depict what should typically be shown by the display. Note, however, that your unit may incorporate a newer, enhanced version of the system (e.g., includes newer sounds), so what you actually see in the display may not always match what appears in the manual.

Handling CD-ROMs

- Avoid touching or scratching the shiny underside (encoded surface) of the disc. Damaged or dirty CD-ROM discs may not be read properly. Keep your discs clean using a commercially available CD cleaner.

* Microsoft and Windows are registered trademarks of Microsoft Corporation.

* The screen shots in this document are used in compliance with the guidelines of the Microsoft Corporation.

* Windows® is known officially as: "Microsoft® Windows® operating system."

* Apple and Macintosh are registered trademark of Apple Computer, Inc.

* Mac OS is a trademark of Apple Computer, Inc.

* All product names mentioned in this document are trademarks or registered trademarks of their respective owners.

* OMS is a registered trademark of Opcode Systems, Inc.

* FreeMIDI is a trademark of Mark of the Unicorn, Inc.

Contents

USING THE UNIT SAFELY	2
IMPORTANT NOTES	4
Main features	11
Front and Rear Panels	13
Front Panel.....	13
Rear Panel	16
Before you begin playing.....	17
Making connections.....	17
Turning the power on/off	18
Adjusting the display contrast.....	20
Quick Start.....	21
<hr/>	
Listening to the demo song.....	22
Using the key pads to play sounds	23
Playing Different Sounds (Switching Pad Banks).....	23
Playing the patterns	24
Selecting and playing patterns.....	24
Changing the tempo	26
Changing the playback key	27
Playing a Pattern Using a Different Sound (Switching Kits).....	28
Using the TSC function to modify the tone and ambience.....	30
Playing your guitar/bass along with patterns.....	32
Using the special guitar/bass effects	33
Chapter 1 An overview of the DR-880	35
<hr/>	
DR-880 Application Guide (from pattern creation to playback)	36
Patterns and Songs.....	38
Patterns.....	38
Songs.....	39
About kits.....	40
Pad bank.....	41
About TSC (Total Sound Control).....	42
Guitar/Bass section.....	43
Guitar Effects	43
Signal flow (until the sound is output)	44
Output jacks.....	45
Output settings.....	45
Common operations and screen indications.....	46
Switching the Pad Bank	46
Moving the cursor.....	46
Moving between screens (Scrolling)	46

Editing a value	47
The Play screen.....	47

Chapter 2 Patterns (playing, recording, editing)49

Playing a pattern.....	50
Changing the tempo	50
Changing the playback key	50
Switching the display	51
Recording a pattern.....	52
Realtime recording and Step recording.....	52
Before you begin recording	52
<1> Selecting the user pattern you want to record	52
<2> Making basic settings for the pattern.....	53
<3-1> Using realtime recording.....	54
<3-2> Step-recording	55
<4> Recording a chord progression.....	58
<5> Recording a fill-in	60
Pattern editing (Pattern Edit).....	61
Copying a portion of a pattern (Copy Measure).....	61
Inserting blank measures into a pattern (Insert Measure).....	62
Erasing a portion of a pattern (Erase).....	63
Deleting unwanted measures (Delete Measure).....	64
Saving a pattern.....	65
Naming a pattern (Pattern Name).....	65
Writing your pattern	65
Copying/Erasing a pattern.....	66
Copying a pattern.....	66
Erasing a pattern	66

Chapter 3 EZ Compose/Groove Modify67

Using EZ Compose.....	68
Creating a pattern	68
Adding a chord progression	69
Adding a fill-in	70
Using Groove Modify	71
Applying volume changes (Velocity Modify)	71
Adding ghost notes	72
Creating a shuffle rhythm	73

Chapter 4 Song (record/edit/play)75

Recording a song	76
Before you begin recording	76
<1> Selecting the user song you want to record	76
<2> Making basic settings for the song	76
<3> Step-recording your song	77
Saving your song	79
Naming your song (Song Name).....	79
Writing your song.....	79
Copying/Clearing a song	80
Copying a song	80
Clearing (erasing) a song.....	80
Playing a song	81
Changing the tempo	81
Changing the playback key	82
Looping the playback in a specified region	82
Switching the display	83

Chapter 5 Playing your guitar/bass85

Using effects	86
Switching effect patches.....	86
Editing an effect patch (Patch Edit).....	86
Saving/Copying an Effect patch	88
Naming an effect patch.....	88
Writing an effect patch.....	88
Copying an effect patch	89
Using the Tuner/Expression pedal	90
Tuning your guitar/bass	90
Using an expression pedal as a volume pedal	91
Guitar effects parameter list	92
GTR MULTI (Guitar multi)	92
BASS MULTI	92
ACO (Acoustic) MULTI.....	92
Description of the effects	93

Chapter 6 Editing the TSC settings.....99

TSC patch editing	100
Edit procedure.....	100
Saving/Copying a TSC patch	103
Naming a TSC patch.....	103
Writing a TSC patch	103
Copying a TSC patch.....	104

Chapter 7 Creating an original kit (Kit Edit) 105

Editing a kit	106
Selecting the kit you want to edit	106
Editing the Drum part.....	106
Editing the Bass part.....	110
Saving/Copying a kit	113
Naming a kit.....	113
Writing a kit.....	113
Copying a kit	114

Chapter 8 Convenient function/System settings..... 115

FAVORITE function	116
Recalling the registered content	116
Registering a favorite	117
Saving all current settings.....	118
System settings	119
Adjusting the output signal (Output Setting).....	119
Adjusting the sensitivity of the key pads (Pad Sens)	120
Tuning the bass part.....	120
Using foot switches.....	121
Adding a count-in.....	123
Using the same kit/TSC patch for playing all patterns and songs	123
Specifying the pattern at power-on.....	124

Chapter 9 Using MIDI 125

Playing the DR-880 from an external MIDI device/ Playing an external MIDI device from the DR-880	126
Setting the MIDI channel.....	126
Setting the Volume receive switch	126
Synchronizing the DR-880 with a digital recorder or MIDI sequencer	128
Sync Mode setting.....	128
Recording an external MIDI device's performance on the DR-880	130
Recording a performance from your MIDI keyboard or MIDI pads	130
Recording a performance from your sequencer or rhythm machine.....	130
Transmitting a DR-880 bulk dump/ Receiving a bulk dump back to the DR-880	131
Setting the Device ID.....	131
Transmitting DR-880 data (Bulk Dump).....	131

Chapter 10 Using USB 133

Before you use USB	134
Supported operating systems	134
Notes on Using USB	134
Switching the USB function.....	134
Importing SMF data to create a pattern.....	135
Windows users.....	135
Macintosh users	137
Backing up the DR-880's data.....	138
Windows users.....	138
Macintosh users	139
Reading backup data back into the DR-880 from the computer (Recover).....	141
Windows users.....	141
Macintosh users	142
Exchanging MIDI messages with your computer (MIDI Communication).....	143
Driver installation and settings	143
Switching the USB function.....	143

Appendices 145

Restoring the factory settings (Factory Reset)	146
Troubleshooting	147
Message List	148
Parameter List.....	149
Preset Data List	151
MIDI Implementation Chart	160
Specifications	162
Index	163

Main features

■ High-quality sounds

● Cutting-edge, high-quality waves

The DR-880 makes it easy for you to play rhythm patterns using drum and bass. It contains 440 of the latest, high-quality drum and percussion sounds, plus 40 different bass sounds—and you can vary the velocity to create expressive changes in volume or tone. A complete range of expressive potential is now at your fingertips, allowing you to create the most realistic of sounds, with any amount of dynamism or subtlety you desire. In addition to 100 preset kits, you can create and store 100 of your own original kits.

● Use insert effects for boldly creative sound manipulation

The drum part provides three insert effects processors (three-band EQ and compressor). Since you can apply effects independently to the kick, snare, and other instruments, you can use the effects aggressively for creative purposes. The bass part provides a compressor and COSM amp, giving you the realistic sound of a bass played through an amp.

COSM (Composite Object Sound Modeling)

Composite Object Sound Modeling (COSM) is an original sound modeling technology developed by Roland, in which the many factors that make up the original sound, such as the electrical circuitry, structural characteristics, materials used, and acoustics, are analyzed and then recombined to reproduce that same sound.

● TSC (Total Sound Control) function

TSC is a function that adjusts the overall tonal character and reverberation. A stereo three-band equalizer and high-quality reverb let you create anything from natural-sounding ambience to the reverberation of a wide range of rooms and halls.

TSC settings are stored as patches and can be switched easily. In addition to twenty preset patches, you can create and store twenty of your own.

■ Rhythm Patterns and Songs

The DR-880 contains 500 preset rhythm patterns, and also lets you create 500 of your own original rhythm patterns. In addition to realtime recording or step input, you can use the EZ Compose functions or the Groove Modify function to create original patterns easily. You can connect multiple rhythm patterns to create a “Song,” and save up to one hundred such songs that you create.

● EZ Compose

The EZ Compose functions make it easy to create high-quality original patterns with a great rhythmic feel, without having to input notes one by one. The three EZ COMPOSE buttons on the panel let you use these functions in combination with each other.

[PATTERN]

This function lets you create an original rhythm pattern simply by choosing a phrase for each component; hi-hat, kick and snare, percussion, and bass.

[CHORD PROGRESSION]

This function lets you add a chord progression to the bass part simply by choosing a chord progression template. It’s an incredibly easy way to create a repeating chord progression or to set up a blues progression.

[FILL IN]

A rich variety of fill patterns are provided, ranging from light fills to fills that occupy an entire measure. Simply choose a fill pattern and paste it into your rhythm pattern.

● Groove Modify function

This lets you easily add “ghost notes,” which are otherwise difficult to add when inputting notes one at a time. You can adjust Shuffle or Velocity to give your rhythm pattern the perfect groove.

■ Guitar/bass input

The DR-880 provides a guitar/bass input jack and built-in high-quality multi-effects, including a COSM AMP effect. You can connect your guitar/bass directly to the DR-880 and play along with the rhythm patterns using sounds that are just as realistic as if you were playing through an actual amp.

The built-in multi-effects processing provides algorithms for electric guitar, acoustic guitar, and bass. Settings for each effect are stored as “patches,” and you can choose from fifty preset patches as well as store fifty more patches with your own edited settings. There’s also a tuner function that let’s you tune your guitar/bass while it’s still connected.

■ Convenient functionality and plenty of connectors

● Large backlit display

The large custom LCD shows chord progressions, patterns, performance information, and editing data in an easily understood fashion.

● FAVORITE function

Frequently used patterns, songs, or effect patches can be registered to a button for immediate recall. This lets you play the desired pattern/song or switch guitar effects simply by pressing a button. Since this function lets you use four buttons x 20 banks, you can register a total of 80 patterns, songs, or effect patches.

● Control via foot switch

You can connect up to four foot switches (sold separately). Even while playing your guitar or bass, you can use your feet to control the DR-880—ideal for jam sessions or on-stage performances. When making the assignments to the foot switches, you can choose from a wide range of functions, including starting/stopping playback, switching patterns, setting tap tempo, or switching guitar effects.

You can also connect an expression pedal and use it for pedal control of the volume, or as a wah pedal.

● A wide range of output jacks

In addition to phone jacks, RCA phono jacks are also provided for master output, making it easy to connect the DR-880 to a wide range of equipment including mixers, amps, and audio equipment.

There’s also a coaxial-type digital output jack, letting you record the DR-880’s output in digital form directly to your digital recorder without any loss in audio quality.

Two individual outputs are also provided. You can use these to send only the output of a connected guitar/bass to your amp, or to use an external effects processor on a specific instrumental sound.

● USB connector

When the DR-880 is connected to your computer via the USB connector, you can load SMF data and use it as rhythm patterns. The USB connector can also be used as a MIDI interfacing.

● Synchronized playback with digital recorders and MIDI sequencer

You can use MIDI to synchronize the DR-880 with digital recorders, such as those in the BR series, or with your MIDI sequencer. The playback from your external MIDI device can also be recorded on the DR-880.

● Dynamics-capable key pads

The dynamics-capable key pads allow the volume or tone to be altered depending on the force used when tapping a pad. When recording a pattern, variations in the force with which you tap the pads can be recorded as the strength (velocity) of the notes.

Front and Rear Panels

Front Panel

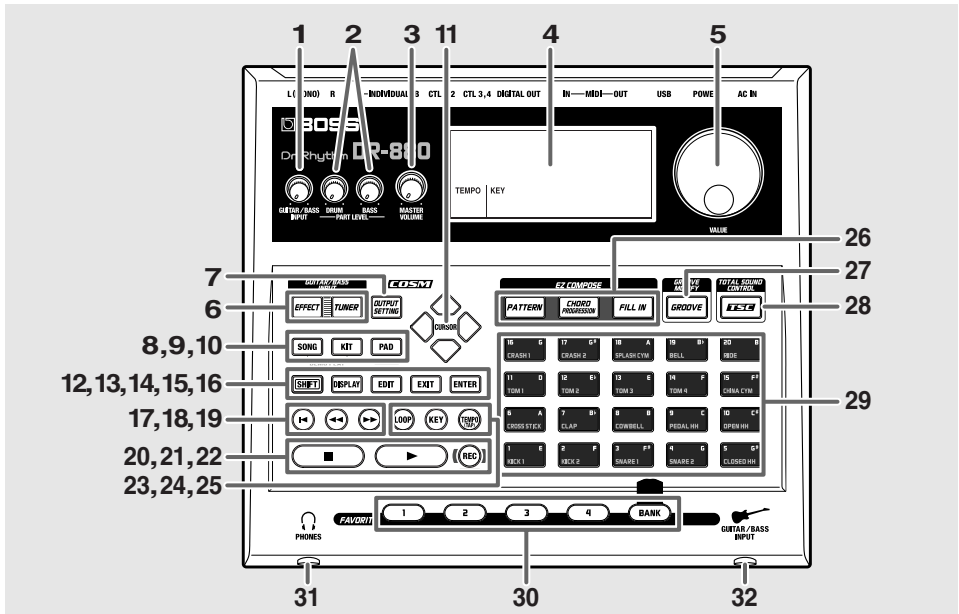

1. GUITAR/BASS INPUT Knob

Adjusts the level of the guitar or bass connected to the GUITAR/BASS INPUT jack.

2. PART LEVEL

DRUM Knob

Adjusts the volume of the drum part.

BASS Knob

Adjusts the volume of the bass part.

3. MASTER VOLUME Knob

Adjusts the volume of the entire DR-880.

4. Display

Shows the current mode and settings.

5. VALUE Dial

Use this to edit the value of a setting.

6. GUITAR/BASS INPUT

You will use these buttons for a guitar or bass you've connected to the GUITAR/BASS INPUT jack.

EFFECT Button

Use this button to change the guitar/bass effect, turn it on/off, or edit the settings.

TUNER Button

Use this button to tune your guitar/bass.

7. OUTPUT SETTING Button

Use this button to adjust the output signal.

8. SONG/PATTERN Button

Switches between Song mode and Pattern mode.

9. KIT Button

Use this button to switch kits.

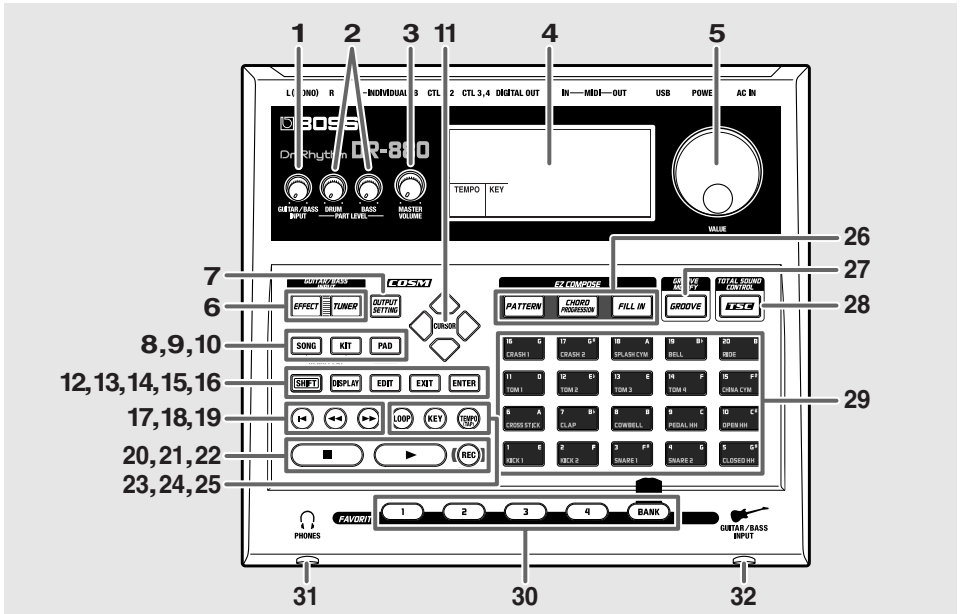

10. PAD Button

Use this button to switch pad banks.

11. CURSOR Buttons

Use these buttons to move the cursor.

12. SHIFT Button

Use this button to access alternate functions of other buttons.

13. DISPLAY Button

Use this button to switch the contents shown in the Pattern or Song Play screen.

14. EDIT Button

Use this button to edit settings.

15. EXIT Button

Use this button to exit from an edit screen.

16. ENTER Button

Use this button to finalize a selection or confirm a value.

17. ◀ (Reset) Button

Returns you to the beginning of the song or pattern.

18. ◀◀ (Rewind) Button

Moves the playback location toward the beginning of the song or pattern.

19. ▶▶ (Fast-Forward) Button

Moves the playback location forward in the song or pattern.

20. ■ (Stop) Button

Stops playback of the song or pattern.

21. ▶ (Play) Button

Starts playback of the song or pattern.

22. REC (Recording) Button

Press this button to record a pattern in real time (p. 54).

23. LOOP Button

Switches loop playback (p. 82) on/off for the song.

24. KEY Button

Use this button to change the playback key of a song or pattern.

25. TEMPO (TAP) Button

Use this button to specify the playback tempo of a song or pattern.

You can also set the tempo by tapping (lightly striking) this button at regular intervals (the Tap Tempo function).

26. EZ COMPOSE

Press these buttons to use the EZ Compose functions.

PATTERN Button

Use this button to easily create patterns.

CHORD PROGRESSION Button

Use this button to easily add chord progressions.

FILL IN Button

Use this button to easily add fill-in patterns.

27. GROOVE MODIFY Button

Press this button when you want to use the Groove Modify function.

28. TSC (Total Sound Control) Button

Use this button to switch the TSC patch on/off, or to edit the settings. (p. 30, p. 100)

29. Key Pads

These pads play drum sounds and bass sounds.

30. FAVORITE

You can use these buttons to register eighty (20 banks x 4) of your favorite pattern/song numbers or guitar effect patch numbers.

1–4 Buttons

Press one of these buttons to recall the pattern/song or guitar effect patch that is registered to that button.

BANK Button

You can switch favorite banks by pressing down this button and pressing a key pad.

31. PHONES (headphone) Jack

You can connect a set of headphones to this jack.

32. GUITAR/BASS INPUT Jack

You can connect your guitar or bass to this jack.

Rear Panel

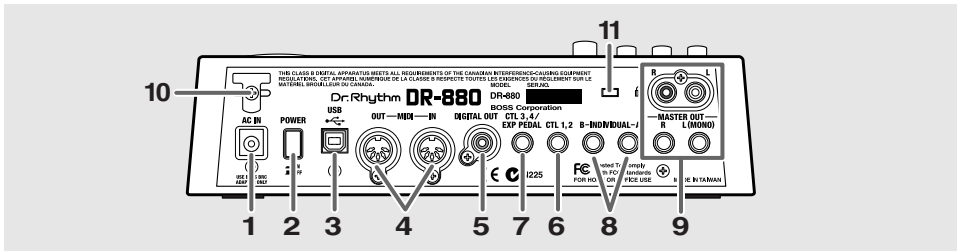

1. AC IN (AC adaptor) Jack

Connect the included BRC-series AC adaptor to this jack.

NOTE

Never connect any AC adaptor other than the BRC-series; doing so will cause malfunctions.

2. POWER Switch

This is the power switch that turns the DR-880 on/off.

3. USB Connector

This connector lets you use a USB cable to connect the DR-880 to your computer.

4. MIDI Connectors (IN/OUT)

These connectors receive (IN) and transmit (OUT) MIDI data.

Use MIDI cables to connect them to your MIDI sequencer or MIDI sound module.

5. DIGITAL OUT Connector

This is a coaxial-type connector that outputs digital audio signals.

It outputs the same sound as the MASTER OUT jacks.

Connect it to your digital recorder.

6. CTL 1, 2 Jack

You can connect foot switches (FS-6 or FS-5U; sold separately) here and use them to control various functions of the DR-880.

7. CTL 3, 4/EXP PEDAL Jack

You can connect foot switches (FS-6 or FS-5U; sold separately) or an expression pedal (Roland EV-5; sold separately) here and use them to control various functions of the DR-880.

8. INDIVIDUAL A, B Jacks

These jacks output only the sounds you specify.

9. MASTER OUT JACKS R/L (MONO)

These are the audio signal output jacks. Both phone jacks and RCA phono jacks are provided.

If you're using the phone jacks, connect your equipment to the L (MONO) output if you're listening in monaural.

10. Cord Hook

Loop the cord from the supplied AC adaptor around this hook. In the event that the cord gets tugged on accidentally, this will prevent the plug from coming out and causing the power to fail, and will prevent excessive strain from being placed on the AC adaptor jack.

11. Security Slot (SECURITY LOCK)

<http://www.kensington.com/>

Before you begin playing

Making connections

The DR-880 does not contain an amp or speakers. In order to produce sound, you'll need to connect an amp or audio system, or stereo headphones.

Audio cables, MIDI cables, stereo headphones, and foot switches are not included. You can purchase them separately from your dealer.

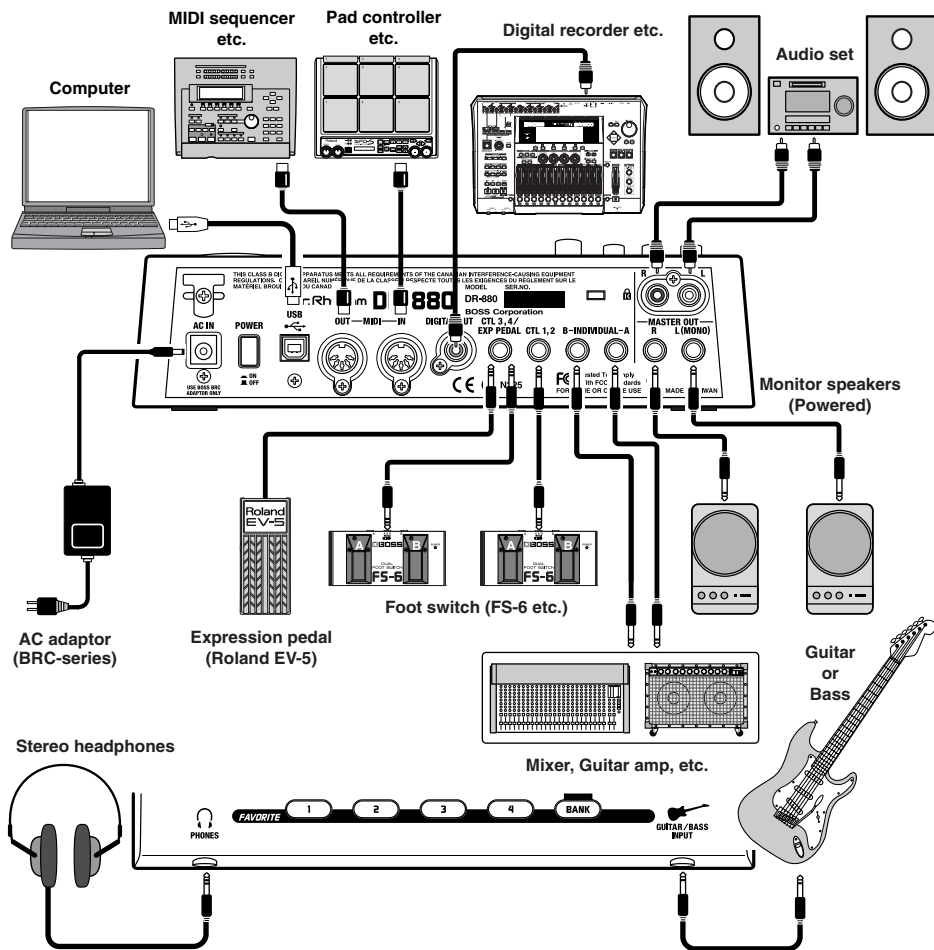

NOTE

To prevent malfunction and/or damage to speakers or other devices, always turn down the volume, and turn off the power on all devices before making any connections.

* To prevent the inadvertent disruption of power to your unit (should the plug be pulled out accidentally), and to avoid applying undue stress to the AC adaptor jack, anchor the power cord using the cord hook, as shown in the illustration.

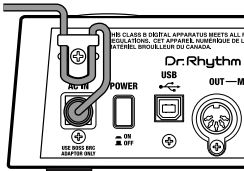

1 Before you start making connections, check the following:

- Have you turned down the volume controls of the DR-880 and the connected amp or other equipment?
- Have you turned off the power of the DR-880 and the connected amp or other equipment?

2 Connect your amp or audio system (or headphones) as shown in the diagram.

We recommend that you use a stereo playback system in order to take full advantage of the DR-880's capabilities.

If you are using the DR-880 with a monaural playback system, connect it to the OUTPUT L (MONO) jack.

Turning the power on/off

■ Turning the power on

Once the connections have been completed (p. 17), turn on power to your various devices in the order specified. By turning on devices in the wrong order, you risk causing malfunction and/or damage to speakers and other devices.

1 Before you turn on the power, check the following:

- Is the DR-880 correctly connected to your other equipment?
- Have you turned down the volume of the DR-880 and your connected amp or playback system?

2 Turn on the POWER switch located on the DR-880's rear panel.



The following appears in the display, and the unit switches to performance mode. The screen that appears at that point is called the “**Pattern Play screen.**”

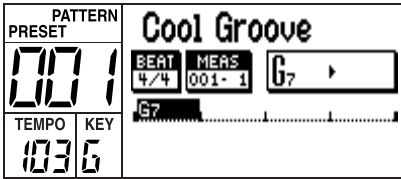

NOTE

This unit is equipped with a protection circuit. A brief interval (a few seconds) after power up is required before the unit will operate normally.

3 Turn on the power of your amp and other connected equipment.

4 Press [▶].

Playback will begin.

While listening to the playback, turn the MASTER VOLUME knob and PART LEVEL (DRUM, BASS) knobs to adjust the DR-880's volume.



Adjust the volume appropriately on your connected amp or playback system.

5 Press [■] to stop playback.

■ Turning the power off

1 Before you turn off the power, check the following:

- Have you turned down the volume of the DR-880 and your connected amp or playback system?

2 Turn off the power of your amp or connected playback system.

3 Turn off the power of the DR-880.

Adjusting the display contrast

Depending on the location in which the DR-880 is placed, you may find the display difficult to read. If so, adjust the contrast of the display as follows.

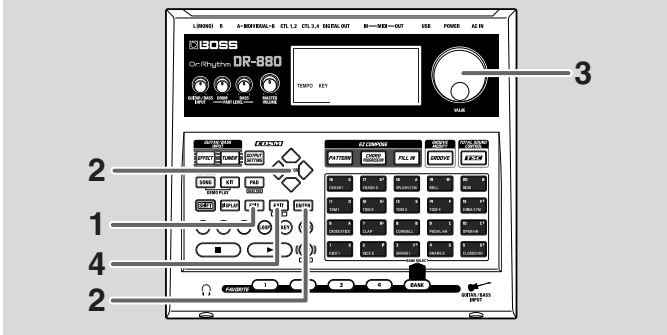

- 1 Press [EDIT].
The edit menu screen appears.

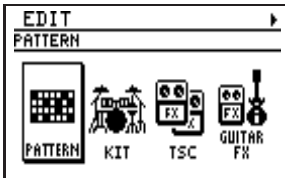

- 2 Use [CURSOR] < / > to move the cursor to the "LCD" icon and press [ENTER].
The LCD contrast setting screen appears.

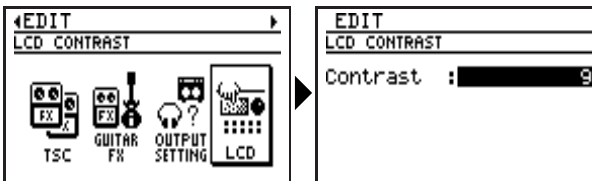

- 3 Use the [VALUE] dial to adjust the contrast (range: 1–16).
- 4 When you've made the setting, press [EXIT].
The message "Now writing..." will appear, and the contrast will be saved.
When the contrast has been saved, the message will disappear.

* Do not turn off the power while the message is displayed. Your data may be damaged if you do so.

Quick Start

Listening to the demo song

Let's start by listening to a demo song that shows off the capabilities of the DR-880.

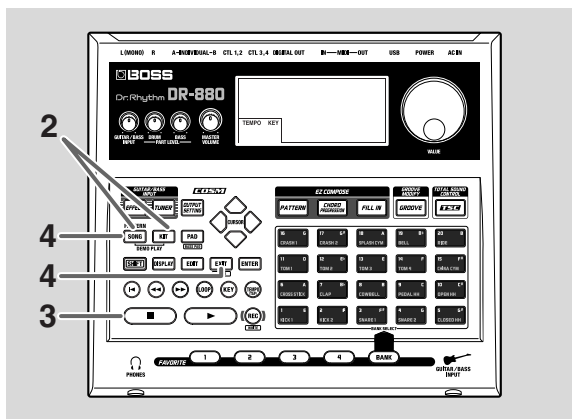

- 1 Make sure that the Pattern Play screen (p. 19) is displayed.

If it is not displayed, press [EXIT] a number of times until the Pattern Play screen is displayed.

- 2 Hold down [SONG] and press [KIT].

The DR-880 will enter Demo mode, and playback will start.

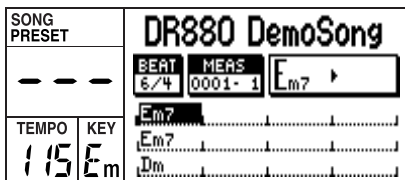

- 3 To stop the demo playback, press [■].

When you press [▶], playback will start from where you had stopped.

When the demo song plays to the end, it will continue playing from the beginning.

- * No data for the music that is played will be output from MIDI OUT.

- 4 To exit Demo mode, press [SONG/PATTERN] or [EXIT].

NOTE

All rights reserved.

Unauthorized use of this material for purposes other than private, personal enjoyment is a violation of applicable laws.

MEMO

You can select Demo mode if the Pattern Play screen or the Song Play screen (p. 75) is displayed.

DR-880 Demo Song

Copyright © 2004
BOSS Corporation

Using the key pads to play sounds

Here's how to use the key pads to play the DR-880's built-in sounds.

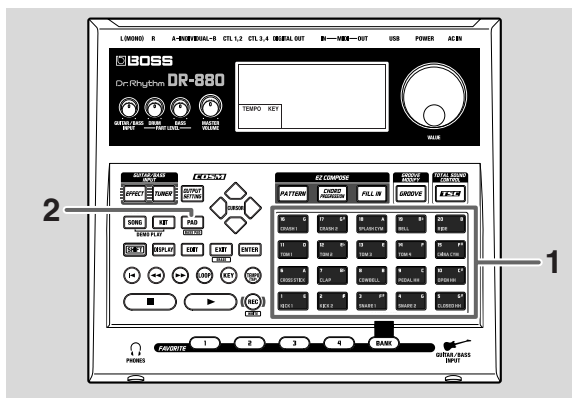

- 1 Strike the key pads.

The drum sound (instrument) assigned to each key pad will play.

MEMO

The key pads are velocity-sensitive; the volume or tone will vary according to how strongly you strike a pad.

Playing Different Sounds (Switching Pad Banks)

You can have different instruments sound, even when the same key pad is tapped, by switching the pad bank.

- 2 Press [PAD].

Press [PAD] to select among the DRUM 1–3 pad banks; the currently selected pad bank is shown in the screen.



- * After a short while, you will automatically return from the pad bank setting screen to the previous screen.

You can press a key pad to play the instrument that's assigned to that pad.

MEMO

Pad banks are collections of drum instrument sounds that are assigned as a single group to the twenty key pads. There are three drum banks, DRUM 1 to 3.

MEMO

Hold down [SHIFT] and press [PAD] to switch to the bass pads. When you strike a key pad, the bass tone will sound at the pitch (note name) printed at the upper right of the key pad you struck.

For more details on the pad banks, refer to p. 41.

Playing the patterns

The DR-880 contains 500 preset patterns and 500 user patterns.
Here's how to play these patterns to hear how they sound.

MEMO

A "pattern" is two to four measures of rhythm performance data designed to be played back repeatedly.

Selecting and playing patterns

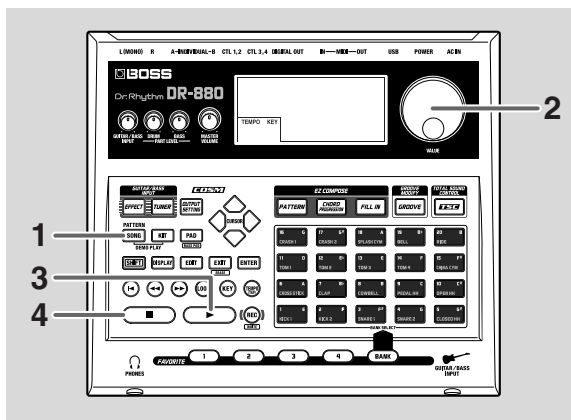

MEMO

Preset patterns can be edited temporarily, but you can't overwrite your changes back onto a preset pattern.

User patterns can be freely edited and overwritten as desired.

- 1 Press [SONG/PATTERN] to make the "PATTERN" indication appear.

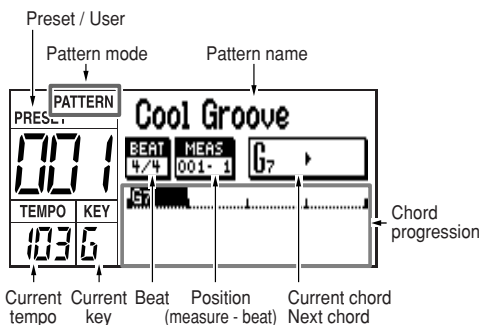

- 2 Use the VALUE dial to select the pattern you want to play.

Following preset patterns 001–500 you can also select from user patterns 001–500.

- * If you turn the VALUE dial while holding down [SHIFT], the pattern number will change in steps of ten.
- * You can hold down [SHIFT] and press [SONG/PATTERN] to switch between preset (P) and user (U).

3 Press [▶].

The selected pattern will begin playing.

During playback, you can turn the VALUE dial to reserve the pattern to be played next.

The name of the reserved pattern is highlighted.

When the current pattern finishes playing, the reserved pattern will start playing.

- * If you press [CURSOR] ◀ / ▶ during playback, you will switch to the previous/next pattern, and it will start playing immediately.

This is convenient when you want to listen to the patterns while you're selecting among them.

4 To stop playback, press [■].

If you press [▶] once again, playback will resume from where it was stopped.

If you press [◀] and then press [▶], playback will start from the beginning of the pattern.

For more on the Preset Patterns, refer to p. 156.

MEMO

The DR-880's patterns contain a "drum part" and a "bass part." The drum part plays drum and percussion sounds, and the bass part plays bass sounds.

Changing the tempo

Here's how to change the playback tempo of the pattern.

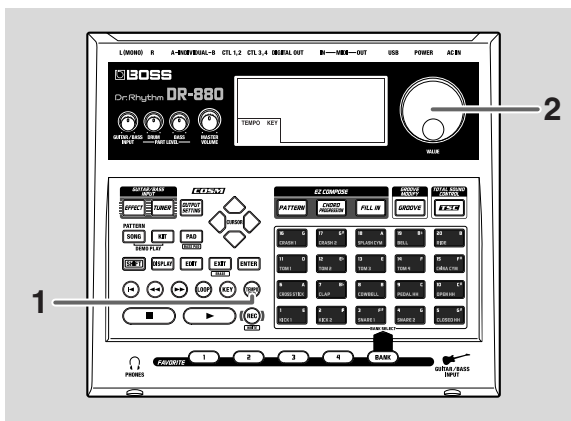

- 1 Press [TEMPO (TAP)].

The tempo setting screen appears.

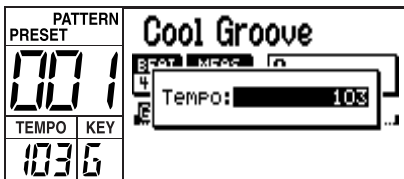

- 2 Use the VALUE dial to adjust the tempo.

The tempo can be adjusted within the range from 20 through 260.

You can also specify the tempo by pressing [TEMPO (TAP)] at the desired interval. This function is called “tap tempo.”

Press [TEMPO (TAP)] four or more times at intervals of the desired tempo.

The tempo will be set to the interval at which you pressed the button, and the current tempo will be displayed in the tempo setting screen.

- * After a short while, you will automatically return from the tempo setting screen to the previous screen.

Changing the playback key

Here's how to change the playback key (pitch) of a pattern. This function is called "key shift."

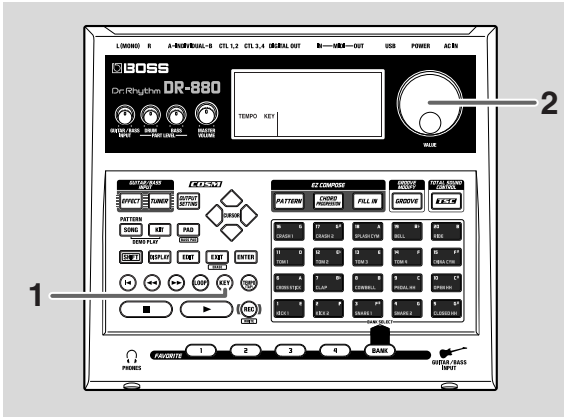

- 1 Press [KEY].

The Key Shift Setting screen appears.

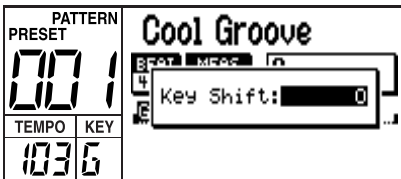

- 2 Use the VALUE dial to change the key.

Range: -12+12

You can change the key in semitone steps over a range of ± 1 octave.

- * After a short while, you will automatically return from the key shift setting screen to the previous screen.

Playing a Pattern Using a Different Sound (Switching Kits)

Even when using the same pattern, you can change the mood (the performance and the way it is played) of the pattern by altering the instruments from which the pattern is made up.

Here, try playing the same pattern with various different instrument, changing kits while the performance is in progress.

The DR-880 features 100 Preset Kits along with 100 additional User Kits whose settings you can change.

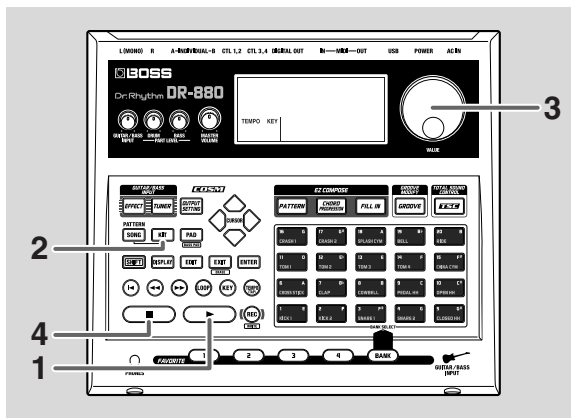

1 Press [▶] to start the performance of the pattern.

2 Press [KIT].

The Kit Setting screen appears.



3 Use the VALUE dial to select a kit.

Try switching among the kits and listening to the different sounds.

MEMO

A "kit" is a collection of 60 drum instruments and one bass tone that is selected as a single set.

MEMO

Preset kits can be edited temporarily, but you can't overwrite your changes back onto a preset kit.

User kits can be freely edited and overwritten as desired.

Following preset kits P001–P100 you can also select from user kits U001–U100.

- * *If you turn the VALUE dial while holding down [SHIFT], the kit number will change in steps of ten.*
- * *You can hold down [SHIFT] and press [kit] to switch between preset (P) and user (U).*

4 To stop playback, press [■].

- For more details on the kits, refer to p. 40.
- For more on the Preset Kits, refer to p. 154.
- When you want to make changes to the kit settings, refer to “Chapter 7 Creating an original kit (Kit Edit)” (p. 105).

Using the TSC function to modify the tone and ambience

Total Sound Control (abbreviated as TSC) is a function that gives you overall control of the tone and ambience. Settings for tone and ambience are stored in “TSC patches,” letting you change the tone and ambience simply by switching patches.

The DR-880 provides 20 preset TSC patches and 20 user TSC patches.

MEMO

Preset patches can be edited temporarily, but you can't overwrite your changes back onto a preset patch.

User patches can be freely edited and overwritten as desired.

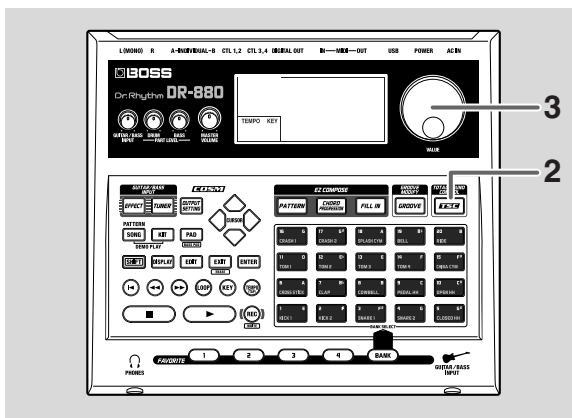

1 Press [▶] to start the performance of the pattern.

2 Press [TSC].

The TSC setting screen appears.

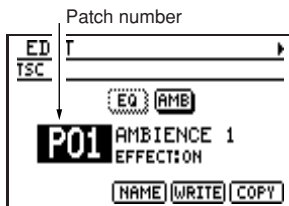

3 Use the [VALUE] dial to select a TSC patch.

Try switching among the TSC patches and listening to the different sounds.

Following preset patches P01–P20 you can also select from user kits U01–U20.

- * *If you turn the VALUE dial while holding down [SHIFT], the patch number will change in steps of ten.*
- * *You can hold down [SHIFT] and press [TSC] to switch between preset (P) and user (U).*
- * *Each time you press [TSC], the TSC function will turn on (button lit) or off (button unlit).*

- For more details on the TSC, refer to p. 42.
- For more on the Preset patches, refer to p. 155.
- When you want to make changes to the TSC patch settings, refer to “Chapter 6 Editing the TSC settings” (p. 99).

Playing your guitar/bass along with patterns

Here's how to connect your guitar/bass to the DR-880 and play along with the patterns.

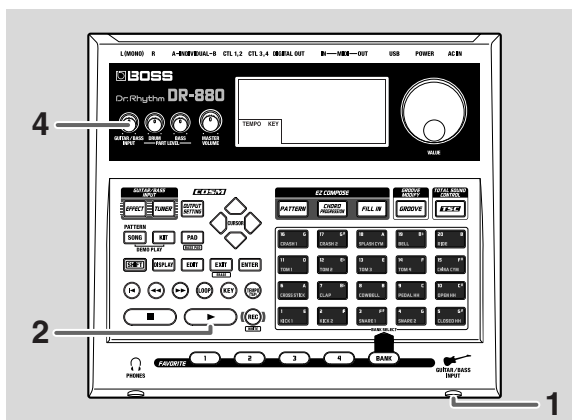

- 1 Connect your guitar/bass to the GUITAR/BASS INPUT jack. (p. 15)
- 2 Select a pattern (p. 24), and press [▶] to make the pattern start playing.
- 3 Play your guitar/bass.
- 4 Use the GUITAR/BASS INPUT knob to adjust the volume of your guitar/bass.

- You can use the DR-880's Tuner function to tune your guitar/bass. For details, refer to "Tuning your guitar/bass" (p. 90).
- You can connect an expression pedal to the rear panel CTL 3, 4/EXP PEDAL jack, and use it to control the volume of your guitar/bass. For details, refer to "Using an expression pedal as a volume pedal" (p. 91)

Using the special guitar/bass effects

The DR-880 provides numerous effects created especially for guitar/bass, and a wide variety of “effect patches” (settings for these effects).

Here’s how to select an effect patch you like from the 50 preset patches and 50 user patches, and play your guitar/bass using the effects.

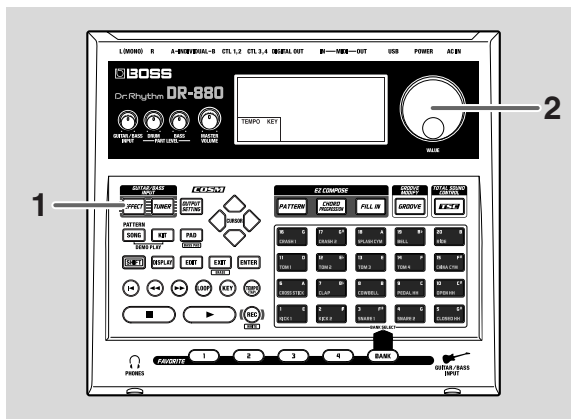

- 1 Press [EFFECT].

The Guitar Effects edit screen appears.

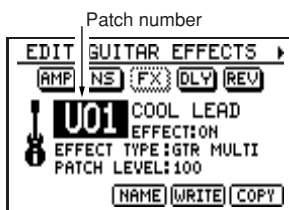

- 2 Use the [VALUE] dial to select a patch.

Try switching among the effect patches and listening to the different sounds.

Following preset patches P01–P50 you can select user patches U01–U50.

MEMO

Preset patches can be edited temporarily, but you can't overwrite your changes back onto a preset patch.

User patches can be freely edited and overwritten as desired.

- * *If you turn the VALUE dial while holding down [SHIFT], the patch number will change in steps of ten.*
- * *You can hold down [SHIFT] and press [EFFECT] to switch between preset (P) and user (U).*
- * *Each time you press [EFFECT], the effect will turn on (button lit) or off (button unlit).*

- For more details on the effect patches, refer to p. 43.
- For more on the Preset patches, refer to p. 155.
- When you want to make changes to the Effect patch settings, refer to “Editing an effect patch (Patch Edit)” (p. 86).

Chapter 1

An overview of the DR-880

This chapter explains the overall structure of the DR-880, and explains the basic operation.

By reading this chapter, you can gain an overall understanding of the DR-880.

DR-880 Application Guide (from pattern creation to playback)

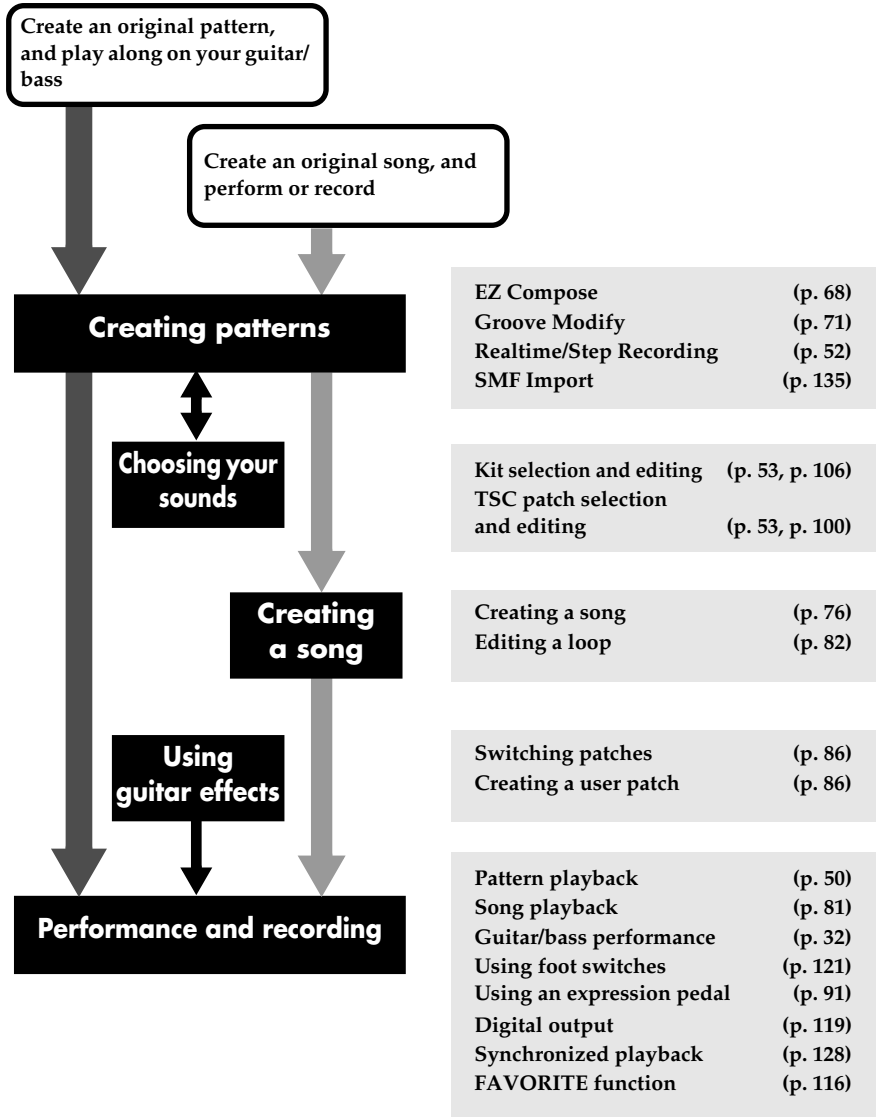

Creating patterns

By using the EZ Compose function you can create original patterns very easily. You can also add chord progressions and fill-ins.

You can use the Groove Modify function to change the rhythmic feel when playing the patterns you create.

Of course, you can also create patterns by realtime recording or step recording. You can also perform pattern editing operations, and even edit individual note data.

You can also import SMF data from your computer via a USB connection and use it as a pattern.

Choosing your sounds

Select a Kit to choose the instrumental sounds you want to play. In addition, you can select a TSC (Total Sound Control) patch to specify the overall sound and ambience. You can also specify the kit and TSC patch used for each pattern.

You can edit kits and TSC patches, and save them as user kits and user patches.

Creating a song

You can create a song by placing your completed patterns in the desired playback order.

By making loop settings you can make a specific region of your song play repeatedly.

Using guitar effects

You can use guitar effects while playing your guitar or bass.

In addition to using the preset patches, you can also create and store user patches.

Performance and recording

You can play back your completed patterns or songs, and play along on your guitar or bass connected to the GUITAR/BASS INPUT. You can use a foot switch to control operations such as start/stop, or use an expression pedal to control guitar volume or a pedal wah effect.

The playback sound from the DR-880 itself and from a connected guitar/bass is output as a digital audio signal from DIGITAL OUT, letting you record it on a digital recorder.

The DR-880's playback can be synchronized via MIDI with your MIDI sequencer or digital recorder. In addition, you can register your favorite patterns, songs, or guitar effect patches in the FAVORITE buttons for instant recall while you perform.

Patterns and Songs

Patterns

On the DR-880, 2–4 measures worth of rhythm performance data designed to be played back repeatedly is called a “pattern.”

A pattern has the following structure.

P500
Pattern name Tempo Kit TSC
Measure 1 2 3 4

P002
Measure 1 2 3 4

P001
Pattern name Tempo Kit TSC
Measure 1 2 3 4
Drum part
Bass part
Chord progression
Am7 F Dm7 G
Fill in

Preset pattern (P001–P500)

U500
Pattern name Tempo Kit TSC
Measure 1 2 3 4

U002
Measure 1 2 3 4

U001
Pattern name Tempo Kit TSC
Measure 1 2 3 4
Drum part
Bass part
Chord progression
Am7 F Dm7 G
Fill in

User pattern (U001–U500)

Drum part

This is the part that plays drum sounds such as hi-hat and snare, and percussion sounds such as cowbell and conga.

Bass part

This is the part that plays the bass sound (bass tone).

Chord progression

This specifies the chord progression to be used when playing the bass.

Fill-in

This setting adds a fill-in during performance. You can choose a fill-in pattern from the fill library (p. 60) so that a fill-in will play at the specified location.

Tempo

This specifies the playback tempo of the pattern.

Kit

This specifies the kit (p. 40) used to play the drum part.

TSC

This specifies the TSC patch (p. 42) that will be used.

Pattern name

A name of up to fourteen characters can be assigned to each pattern.

■ Chord conversions (Arrange)

The DR-880 has an “Arrange” function.

This function converts the bass performance data so that it matches the chords specified by the chord progression.

This means that even if the bass pattern is the same, differences in the chord progression or the specified chords will change the bass performance.

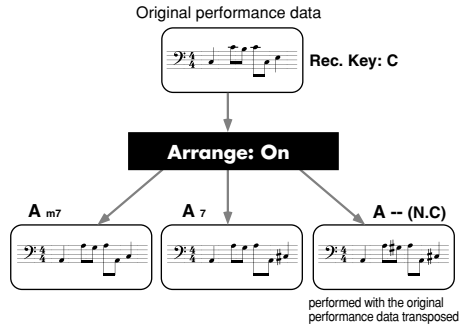

Songs

On the DR-880, a “song” consists of patterns placed in the desired playback order for an entire composition.

A song has the following structure.

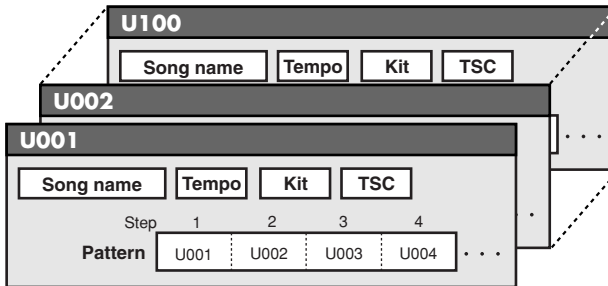

Song (U001–U100)

Pattern

Specify the patterns in the desired order of playback.

Tempo

This specifies the playback tempo of the song. Each pattern in the song also specifies a playback tempo, but you can choose whether playback will be according to the tempo specified within each pattern or the tempo specified for the entire song.

Kit

This specifies the kit (p. 40) used to play the song. Each pattern in the song also specifies a kit, but you can choose whether playback will use the kit specified within each pattern or the kit specified for the entire song.

TSC

This specifies the TSC patch (p. 42) used for the song. Each pattern in the song also specifies a TSC patch, but you can choose whether playback will use the TSC patch specified within each pattern or the TSC patch specified for the entire song.

About kits

The DR-880 contains 440 instruments (drum sounds) and 40 bass tones (bass sounds). From these, collections of 60 instruments and one bass tone have been chosen and stored as “kits.”

An insert effect can also be specified for each kit.

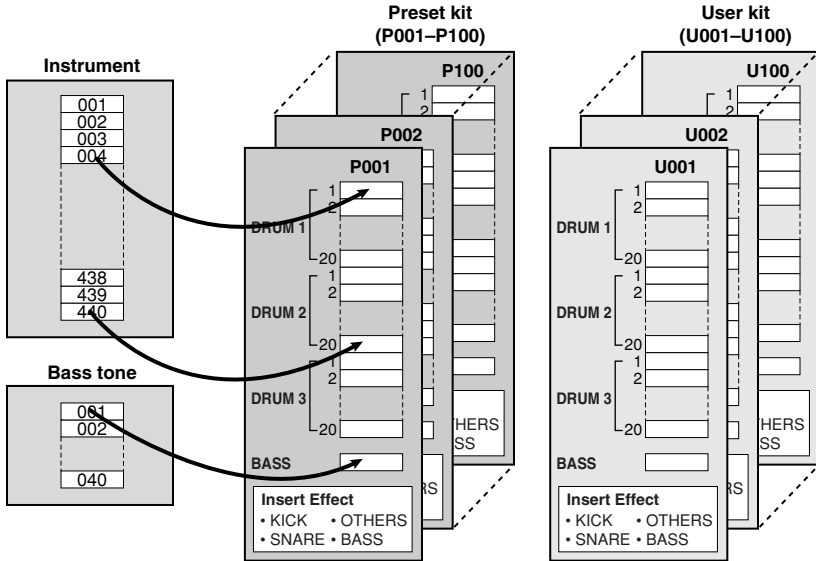

- The DR-880 contains 100 preset kits, and 100 user kits that you are free to modify.
- Each pattern remembers the kit number that was used when creating that pattern. This means that when playing patterns, the kit will also change when you switch kits.

Insert Effect

For each kit you can specify “insert effects” that will be applied directly to the instruments and bass tone.

Insert effects for instruments

Separate equalizer and compressor effects are provided for kick, snare, and other instruments. This lets you apply effects that are appropriate for the character of the instrument.

Insert effects for bass tone

Compressor and bass amp simulator effects are provided.

Pad bank

The instruments (drum sounds) of a kit are organized into three groups with twenty instruments in each group.

These groups are called “pad banks.”

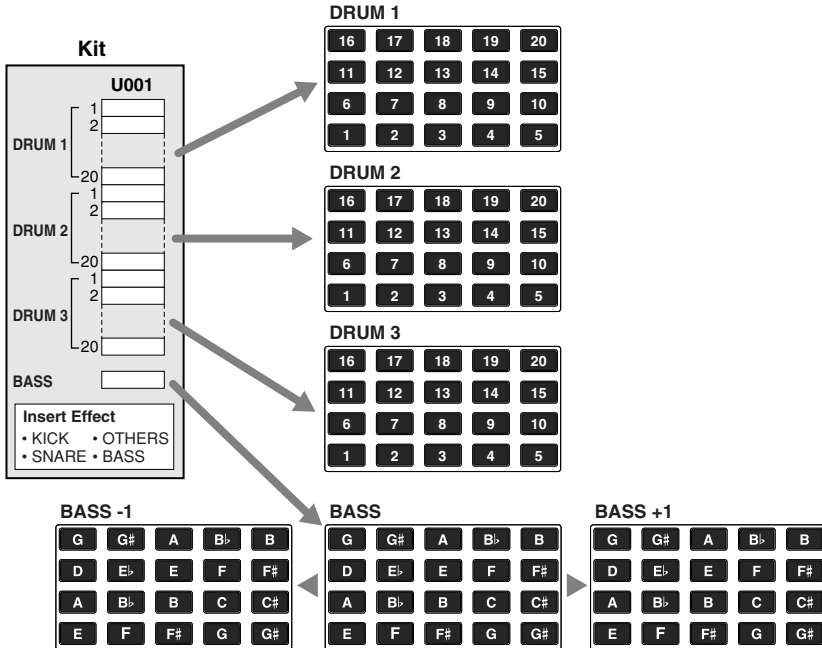

Press [PAD] to select among the DRUM 1–3 pad banks; the currently selected pad bank is shown in the screen.

You can press a key pad to play the instrument that’s assigned to that pad.

Hold down [SHIFT] and press [PAD] to switch to the bass pads. When you strike a key pad, the bass tone will sound at the pitch (note name) printed at the upper right of the key pad you struck.

By holding down [SHIFT] and pressing [PAD] to select “BASS -1” you can play the sounds one octave lower. By selecting “BASS +1” you can play the sounds one octave higher.

About the maximum polyphony

The DR-880 has a maximum polyphony of 32 notes (voices). Some bass sounds use two voices when you play one note, and if you’re using this type of bass sound, the maximum polyphony will be less than 32 notes.

For details on the number of voices used by each instrument, refer to p. 153.

About TSC (Total Sound Control)

Total Sound Control (abbreviated as TSC) is a feature that gives you overall control of the tonal character and ambience.

TSC provides a “stereo three-band equalizer,” which adjusts the overall tone, and a “ambience/reverb,” which adjusts the ambience of the overall sound.

Settings for these two effects are handled together by a “TSC patch.” By switching the TSC patch you can easily obtain a variety of sounds, ranging from natural ambience to various types of room or hall reverberation.

TSC has the following structure.

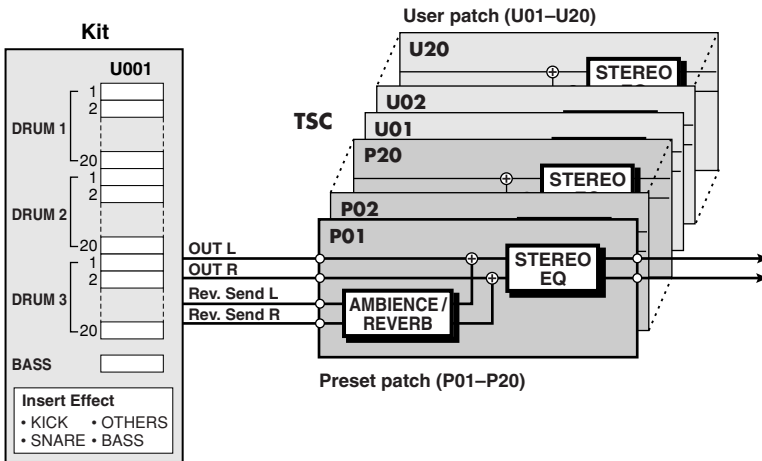

- The DR-880 provides twenty preset TSC patches, and another twenty user TSC patches in which you can store your edited settings.
- You can temporarily edit a preset patch, but can't overwrite your changes onto the original preset pattern. User patches can be freely edited and overwritten.

The DR-880 provides a guitar/bass input jack, letting you play your guitar/bass along with the rhythm performance.

A dedicated effect can be applied to the guitar/bass input.

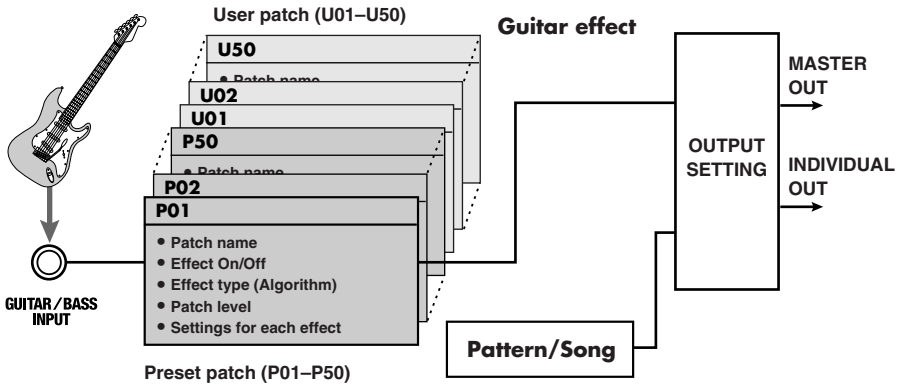

Guitar Effects

The DR-880 contains numerous effects created especially for guitar/bass. The types of effect used and the order in which they are connected are specified by several “algorithms.”

Three algorithms are provided: Guitar Multi, Bass Multi, and Acoustic Multi.

Guitar Multi

This is a multi-effect setup for electric guitar.

Bass Multi

This is a multi-effect setup for bass guitar.

Acoustic Multi

This is a multi-effect setup for acoustic guitar.

MEMO

The order in which the FX are connected will change to the appropriate position for the effect that is selected.

Each effect within the algorithm has various parameters (analogous to the knobs of a compact effect unit), which you can adjust to vary the sound. A choice of algorithm and the parameter settings for each effect are collectively stored as an “effect patch.”

When you switch effect patches, the combination of effects, their on/off status, and the parameter values will all change at the same time. This means you can change instantly to a completely different sound.

Effect patches are organized as follows.

Preset patches 1–50

You can temporarily edit the settings of the preset patches, but can’t write your changes into memory.

User patches 1–50

These patches can be freely edited and overwritten.

Signal flow (until the sound is output)

The following diagram shows the signal flow from the drum part, bass part, and the sound from the GUITAR/BASS INPUT until it reaches the DR-880's audio outputs.

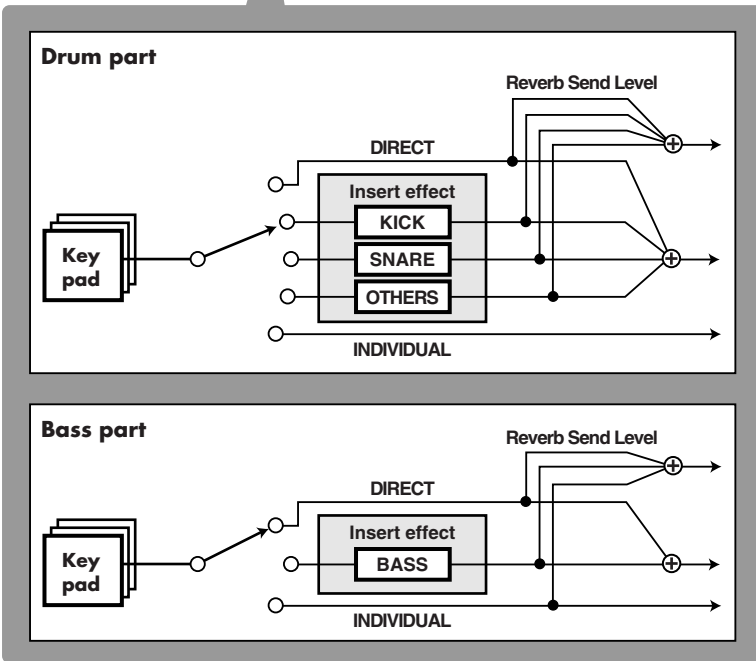
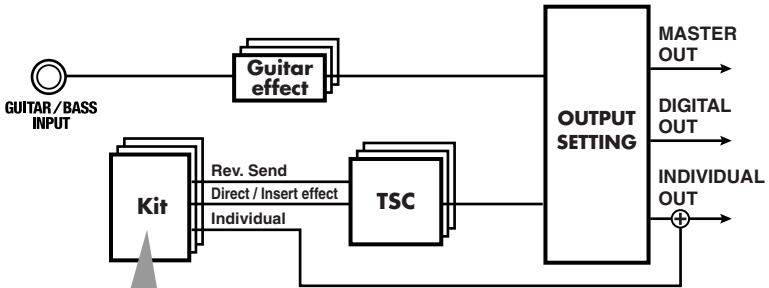

Output jacks

The DR-880 provides MASTER OUT, INDIVIDUAL A/B, and DIGITAL OUT output jacks.

MASTER OUT

These jacks output the sound from the drum part, the bass part, and GUITAR/BASS INPUT.

INDIVIDUAL A/B

You can choose to output only specific sounds from these jacks.

DIGITAL OUT

This jack outputs a digital audio signal that is identical to the output from MASTER OUT.

You can make output assign settings (Out Assign: p. 107–p. 111) for each instrument to specify whether or not it will use the insert effects and whether it will be output from MASTER OUT or INDIVIDUAL jacks.

Output settings

Output settings let you make final adjustments before the sound is sent from MASTER OUT.

- Use “Output Select” to optimize the output for the device that’s connected to MASTER OUT (e.g., amp or audio system).
- Adjust the level of the audio signal that is sent from DIGITAL OUT.
- Use the “2-band Equalizer” to make final adjustments to the sound before it is output.
- Adjust the volume of the ambience.
- Specify the output destination of the GUITAR/BASS INPUT, and specify the device that is connected to the output destination.

Common operations and screen indications

Switching the Pad Bank

Pad Bank

You can press [PAD] to select among the DRUM 1–3 pad banks; the current pad bank is shown in the screen.



* After a short while, you will automatically return from the pad bank setting screen to the previous screen.

You can strike a key pad to play the instrument assigned to that pad.

Bass Pad

By holding down [SHIFT] and pressing [PAD] you can switch to the bass pads. When you strike a key pad, the bass tone will sound at the pitch (note name) printed at the upper right of the key pad you struck.



- Choose BASS -1 to play the bass tone one octave lower.
- Choose BASS +1 to play the bass tone one octave higher.

* After a short while, you will automatically return from the bass pad setting screen to the previous screen.

Moving the cursor

The cursor is shown as reversed (highlighted) text for an editable setting in the screen. When selecting from several icons, the cursor is shown as a frame around the icon.

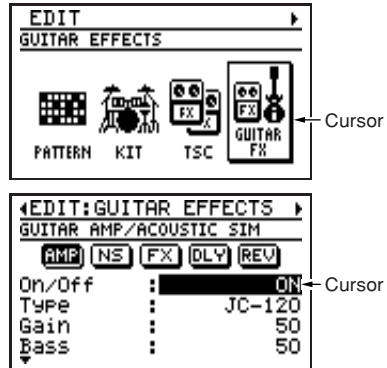

If there are several editable items in the screen, use the [CURSOR] buttons to move the cursor to the item you want to edit.

If you continue holding down a [CURSOR] button, the cursor will continue moving.

Moving between screens (Scrolling)

Whenever you see a “◀” or “▶” symbol in the left or right portion of the screen, it means that additional information that could not fit in the current screen can be found in that direction. Press [CURSOR] ◀ to move to the next screen to the left, or press [CURSOR] ▶ to move to the next screen to the right.

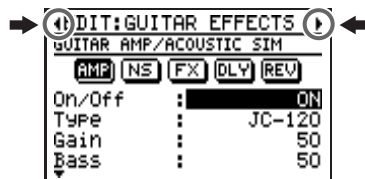

When “▲” or “▼” symbols appear at the left of the screen, it means that additional parameters that could not fit in the current screen can be found in the upward or downward directions.

Use [CURSOR] ▲ / ▼ to scroll upward or downward through the items.



Editing a value

You can turn the VALUE dial to edit the value at the location of the cursor.

To change the value more rapidly, hold down [SHIFT] while you turn the VALUE dial.

Example) Switching the patch number

VALUE dial:

P001 → P002 → P003 → P004 → P005 → ...

[SHIFT] + VALUE dial:

P001 → P011 → P021 → P031 → P041 → ...

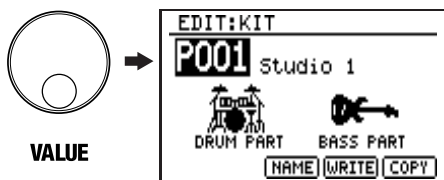

The Play screen

You can change the contents that are shown in the Pattern or Song Play screen (the basic screen for playback).

Pattern Play screen

Press [DISPLAY] to select among the following choices.

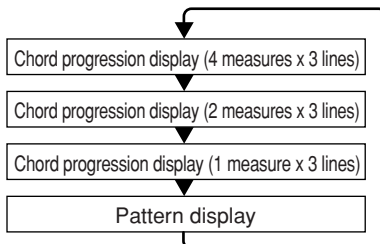

- For details on the contents of the display, refer to p. 51.

Song Play screen

Press [DISPLAY] to select among the following choices.

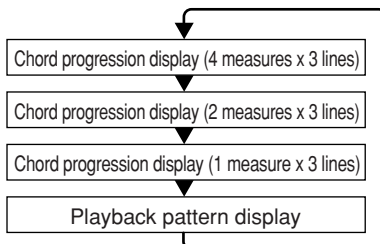

- For details on the contents of the display, refer to p. 83.

MEMO

Chapter 2

Patterns

(playing, recording, editing)

Pattern mode is where you play, create, or edit patterns.
With the Play screen displayed and playback stopped, press [SONG/PATTERN] so “PATTERN” appears in the display.

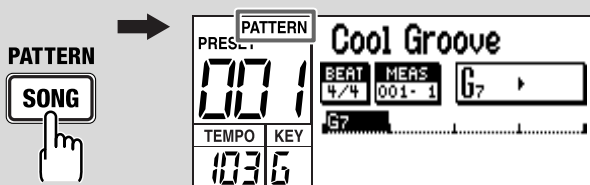

Playing a pattern

1. Use the VALUE dial to select the pattern you want to play.

- * If there is an edited pattern that has not been saved, the message “Cancel edit?” will appear. If you want to save the pattern, press [EXIT] and perform the Write operation (p. 65). If you don't want to save it, press [ENTER].

Following preset patterns 001–500, you can also select from user patterns 001–500.

- * You can hold down [SHIFT] and press [SONG/PATTERN] to switch between Preset (P) and User (U).

2. Press [▶].

The selected pattern will start playing.

- You can turn the VALUE dial during playback to reserve the pattern that will be played next. The name of the reserved pattern is highlighted.

When the current pattern finishes playing, the reserved pattern will start playing.

3. To stop playback, press [■].

- When you press [▶] once again, playback will resume from the point where it was stopped.
- If you press [◀] before pressing [▶], playback will start from the beginning of the pattern.

Changing the tempo

1. Press [TEMPO (TAP)].

The tempo setting screen appears.



2. Use the VALUE dial to adjust the tempo.

You can adjust the tempo within the 20–260 range.

- * After a short while, you will automatically return from the tempo setting screen to the previous screen.

■ Setting the tempo by tapping a button (Tap Tempo)

You can also specify the tempo by tapping [TEMPO (TAP)] at the desired interval.

This function is called “Tap Tempo.”

1. Press [TEMPO (TAP)] four times or more at the desired tempo.

The tempo will be set to the interval at which you pressed the button, and the current tempo will be shown in the tempo setting screen.

- * After a short while, you will automatically return from the tempo setting screen to the previous screen.

Changing the playback key

You can change the key in which a pattern plays back. This is referred to as the “Key Shift” function.

1. Press [KEY].

The key shift setting screen appears.

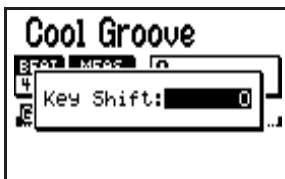

2. Use the VALUE dial to change the key.

Range: -12–+12

You can change the key in semitone steps over a range of ±1 octave.

- * After a short while, you will automatically return from the key shift setting screen to the previous screen.

Switching the display

You can switch the pattern play screen between the “chord progression display” (4 measures x 3 lines/ 2 measures x 3 lines/ 1 measure x 3 lines) and the “pattern display.”

1. Press [DISPLAY].

Press the button repeatedly to cycle through the available choices for the display, as follows:

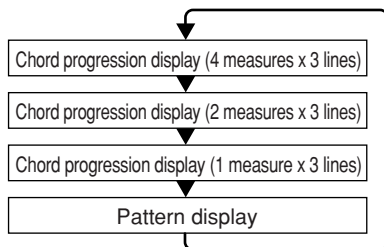

■ Chord progression display

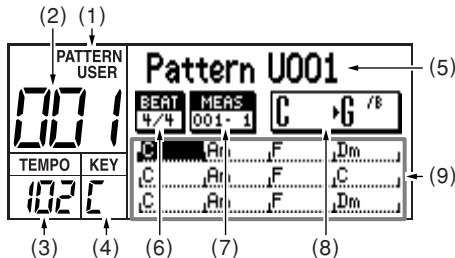

- (1) Pattern mode
- (2) Pattern number
- (3) Current Tempo
- (4) Current key
- (5) Pattern name

An “*” displayed in front of the pattern name indicates that the pattern has been edited.

- (6) Time signature
- (7) Measure – Beat

Indicates the current location.

- (8) Current chord → Next chord

The current chord and next chord are shown in greater detail.

(9) Chord progression

Shows the chord progression of the pattern. The cursor will move as playback progresses, indicating the currently playing measure. Press [DISPLAY] to choose the desired type of display for the chord progression area; either “4 measures x 3 lines,” “2 measures x 3 lines,” or “1 measure x 3 lines.” When fewer measures are displayed in a single screen, you will be able to see the chord progression in greater detail.

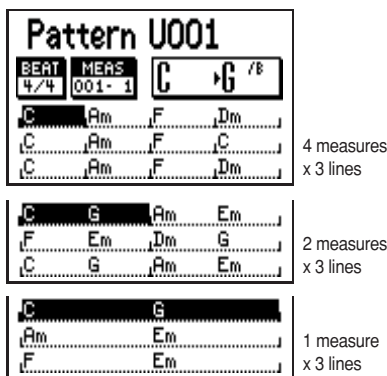

■ Pattern display

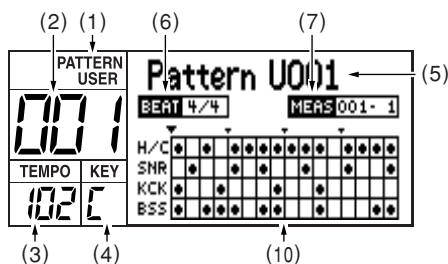

(10) Step

A grid display shows ● symbols to indicate the timing of the important instruments (hi-hat, snare, kick) and the timing at which bass notes are played.

The display will change as playback progresses.

Recording a pattern

Realtime recording and Step recording

Realtime recording

In this method, you strike the key pads while listening to a metronome, and your performance is recorded into the pattern exactly as you play it. Even if the timing at which you strike the key pads is not perfect, you can use the Quantize function to correct your timing.

Step recording

In this method, you specify the timing (step) and volume at which each instrument note will sound, entering notes one by one. Even if you don't feel confident recording a pattern in real time, step recording makes it easy to record a pattern accurately.

You can also combine both realtime recording and step recording to record a pattern.

For example, you can use step recording to edit a portion of a realtime-recorded pattern, or use step recording to create the basic portion of a pattern and then use realtime recording to add more sounds.

Before you begin recording

Here's the procedure for recording a pattern.

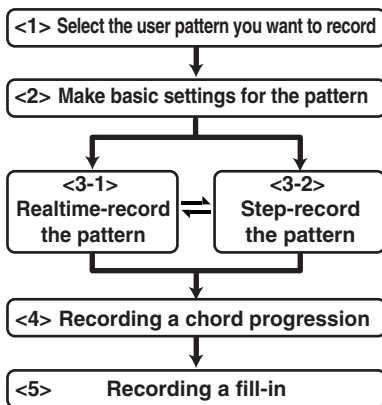

NOTE

Key Shift (pattern information: p. 53) and Chord Progression (p. 58) settings are disregarded when recording patterns.

< 1 > Selecting the user pattern you want to record

1. Access the pattern play screen.
2. Use the VALUE dial to select a user pattern (001–500).

TIP

If desired, you can erase an already-recorded pattern and use it. Refer to "Erasing a pattern" (p. 66).

<2> Making basic settings for the pattern

Here you will make basic settings for the pattern, such as the time signature, the number of measures, and the tempo.

* You can also change these settings after recording.

1. In the pattern play screen, press [EDIT].
The edit menu screen appears.
2. Move the cursor to the “PATTERN” icon and press [ENTER].
The pattern edit menu screen appears.

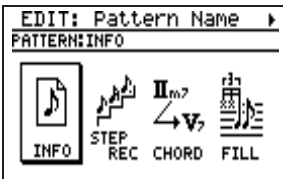

3. Move the cursor to the “INFO” icon and press [ENTER].
The pattern information screen appears.

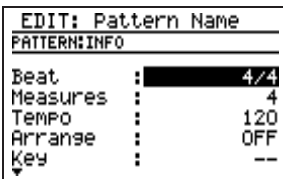

4. Move the cursor to the parameter you want to edit, and use the VALUE dial to set the value.

Parameter/Range	Explanation
Beat	
2/4-8/4, 4/8-16/8	Time signature
Measures	
1-999	Number of measures
* If you increase the number of measures after recording, the corresponding number of blank measures will be added at the end. If you decrease the number of measures, the measures that have thus been eliminated will not be played.	

Parameter/Range	Explanation
Tempo	
20-260	Tempo
Arrange	
OFF, ON	Specifies whether the Arrange function will operate for the bass part
OFF: Use this setting if you want the recorded performance data to be played without change. The Arrange function will not operate.	
ON: The Arrange function will arrange the recorded performance data according to the chord progression.	
Key	
-, C-B, Cm-Bm	The key when playing the pattern
* The key display area in the left of the display shows the key after key shift has been applied. (Example) If the Key = Am and the Key Shift = +2, this is shown as “Bm.”	
Rec.Key	
C-B, Cm-Bm	Key when recording the bass part
* When you specify the key used when recording, the bass part will be arranged according to this setting.	
Key Shift	
-12+12	Transposes the playback key in semitone steps
Kit Number	
P001-P100, U001-U100	Number of the kit used to play this pattern
TSC Switch	
OFF, ON	TSC on/off setting
TSC Number	
P01-P20, U01-U20	Number of the TSC patch used

NOTE

You must set Key and Rec Key correctly. If these are not set correctly, playback may occur in the wrong key in situations such as the following:

- When using a chord progression (p. 58) to arrange the bass part
- When using EZ Compose to create a pattern using Current data (p. 68), and add a chord progression using either Current or USER PATTERN data (p. 69).

<3-1> Using realtime recording

1. Switch to a pad bank or the bass pads, depending on the part you want to record.

To record the drum part

Press [PAD] to select a pad bank 1–3.

To record the bass part

Hold down [SHIFT] and press [PAD] to select the bass pads.

Choose “BASS -1” if you want to record sounds one octave lower, or choose “BASS +1” if you want to record sounds one octave higher.

2. Press [REC].

[REC] will light, and the realtime recording screen appears.

The metronome will also begin sounding.



The screen shows “Rec Standby...” to indicate that you are in recording standby mode.

3. Move the cursor to “Quantize,” and use the VALUE dial to specify the quantization.

When used during realtime recording, the Quantization function corrects any inaccuracies in the timing at which you strike the key pads, so that the strikes will be recorded at precise intervals of the timing unit you specify.

Range		Range	
--	No quantization		8th note triplets
	32nd note triplets		8th notes
	32nd notes		quarter note triplets
	16th note triplets		quarter notes
	16th notes		

4. Move the cursor to “Rec. Velo” and use the VALUE dial to specify the volume (recording velocity) for the instrument or bass tone you are going to record.

1–127:

The notes will be recorded with the velocity you specify, regardless of the force with which you actually struck the key pad.

SENS:

The notes will be recorded with the velocity at which you strike the key pad.

5. Press [▶] to start recording.

[▶] starts blinking in time with the count. The screen indication changes to “Recording...”

* If a pattern has already been recorded, the pattern will begin playing.

6. In time with the metronome, strike the key pads for the instrument or bass sound you’re recording.

* If necessary, press [PAD] (or hold down [SHIFT] and press [PAD]) to switch between the drum part and bass part.

7. If you want to erase notes you recorded by mistake, proceed as follows.

(For an instrument)

Hold down [SHIFT] and press the key pad corresponding to the instrument you want to delete.

(For the bass sound)

Hold down [SHIFT] and press any one of the key pads.

The notes located during the time you continue holding down [SHIFT] and the key pad will be deleted.

8. Repeat steps 6–7 if necessary.

- If you want to rehearse your performance, press [REC] once again.

[REC] starts blinking, indicating you’re in rehearsal mode. The screen display will change to “Rec Rehearsal...”

Strike the key pads in time with the metronome to rehearse your performance.

* Nothing is recorded when you strike the key pads during rehearsal.

When you're finished rehearsing, press [REC] so the button is lit.

The indication in the screen changes to "Recording..." or "Rec Standby..."

9. When you're finished recording, press [■].

10. If you want to save the pattern, proceed to "Saving a pattern" (p. 65).

<3-2> Step-recording

1. Switch to a pad bank or the bass pads, depending on the part you want to record.

To record the drum part

Press [PAD] to select a pad bank 1–3.

To record the bass part

Hold down [SHIFT] and press [PAD] to select the bass pads.

Choose "BASS -1" if you want to record sounds one octave lower, or choose "BASS +1" if you want to record sounds one octave higher.

2. Press [EDIT].

The edit menu screen appears.

3. Move the cursor to the "PATTERN" icon and press [ENTER].

The pattern edit menu screen appears.

4. Move the cursor to the "STEP REC" icon and press [ENTER].

The pattern step-record screen appears.

(Drum part)

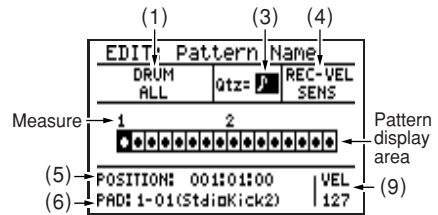

(Bass part)

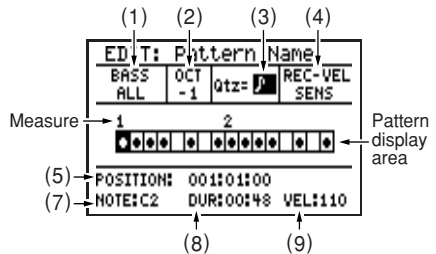

5. Move the cursor to each of the items listed below, and use the VALUE dial to set the value.

(1) DRUM (drum part), BASS (bass part)

This chooses what will be shown in the pattern display area.

(Drum part)

ALL:

All instruments will be shown.

BANK1-PAD01–BANK3-PAD20:

Only the instruments of the selected bank or pad number will be shown.

(Bass part)

ALL:

Note names and pitch bend data will be shown.

NOTE:

Note names will be shown.

PITCH BEND:

Pitch bend data will be shown (p. 57).

(2) OCT (Bass part)

This indicates the state of the bass pads.

NORM:









Normal state.

-1: The bass tone will be one octave lower.

+1: The bass tone will be one octave higher.

(3) Qtz

This specifies the note length into which each measure will be divided. The number of grid lines in each measure of the pattern display will change according to the Quantize setting you choose. Each grid line represents one step.

Range	
	32nd notes
	16th note triplets
	16th notes
	8th note triplets
	8th notes
	quarter note triplets
	quarter notes
	whole notes

(4) REC-VEL

This specifies the volume (velocity) of the instruments/bass notes that you are going to record.

1-127:

The notes will be recorded at the velocity value you specify here, regardless of how strongly you actually strike the key pads.

SENS:

The notes will be recorded with a velocity corresponding to how strongly you strike the key pads.

6. Use [◀◀] [▶▶] to move the cursor within the pattern display area to the step that you want to record, and strike the key pad for the instrument or bass note you want to record.

When an instrument or bass note is recorded, an “●” indication appears.

The velocity is also recorded at this time.

You will automatically advance by one step.

Button operations	
[◀]	Moves the cursor to the beginning of the pattern.
[◀◀]	Moves the cursor to the beginning of the preceding step.
[▶▶]	Moves the cursor to the beginning of the next step.
[SHIFT]+ [CURSOR] ▷	Moves the cursor to where the next instrument or bass note is recorded.
[SHIFT]+ [CURSOR] ◁	Moves the cursor to where the preceding instrument or bass note is recorded.
[SHIFT]+ key pad	Deletes the instrument corresponding to the key pad in the current step. In case of bass note, you can press any key pad.
[SHIFT]+ [EXIT]	Deletes the instrument or bass note recorded at the currently selected position, and moves the cursor to where the next instrument or bass note is recorded.
[ENTER]	Plays the instrument or bass note recorded at the currently selected position.
[▶]	Starts playback from the beginning of the currently selected measure. Press [■] to stop playback.
[DISPLAY]+ key pad	Displays the instrument of that key pad. you can check the sound without recording.

(5) POSITION

This shows the currently selected recording position in “measure:beat:clock” units. You can move the cursor to this indication and use the VALUE dial to specify the measure:beat:clock position, and then strike a key pad to record directly into the specified position.

(6) PAD (Drum part)

This shows the pad bank, pad number, and name of the instrument that is recorded at the currently selected position.

By moving the cursor to this indication and using the VALUE dial to change the pad bank and pad number, you can replace the recorded instrument with the instrument of the pad bank and pad number you specify.

(7) NOTE (Bass part)

This shows the name of the note recorded at the currently selected position.

By moving the cursor to this indication and using the VALUE dial to change the name of the note, you can replace the recorded note with the note you specify.

(8) DUR (Bass part)

This shows the duration (length) of the note recorded at the currently selected position, in units of "beats - ticks."

By moving the cursor to this indication and using the VALUE dial to change the beats and ticks, you can modify the duration of the recorded bass note.

* Beats are divided into "ticks," and there are 96 ticks in one quarter note beat.

(9) VEL

This shows the velocity value of the instrument or bass note recorded at the currently selected position.

By moving the cursor to this indication and turning the VALUE dial, you can modify the velocity value that is recorded.

* You cannot record more than one instance of the same instrument or bass note at the same position. If you attempt to do so, the previous note will be overwritten by the last-recorded note.

7. Repeat steps 5–6 if necessary.

* If necessary, you can press [PAD] (or hold down [SHIFT] and press [PAD]) to switch between the drum part and the bass part.

8. When you are finished recording, press [EXIT].**9. If you want to save the pattern, proceed to "Saving a pattern" (p. 65).****■ Recording pitch bend data in the bass part**

You can record pitch bend data in the bass part. This lets you simulate playing techniques such as hammering-on or pulling-off.

1. Access the step-record screen for the bass part (p. 55).
2. Move the cursor to "BASS" and use the VALUE dial to switch to "P.BEND."

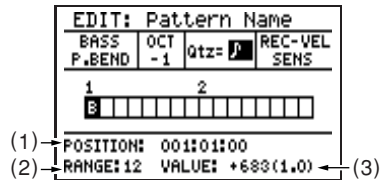

3. Move the cursor to "Qtz" and use the VALUE dial to specify the quantization.

4. Specify the position at which you want to record pitch bend data.

You can either use [◀◀] [▶▶] to move the cursor in the pattern display area to the step that you want to record, or specify the POSITION measure:beat:clock values to set the recording position.

5. Hold down [SHIFT] and press [CURSOR] △ or [CURSOR] ▽ to record pitch bend data.

[SHIFT]+[CURSOR] △ :

The pitch bend amount is raised by a semitone each time you press these keys. (If Bend Range = 12)

[SHIFT]+[CURSOR] ▽ :

The pitch bend amount is lowered by a semitone each time you press these keys. (If Bend Range = 12)

An indication of "B" is shown in the pattern display area where pitch bend data has been recorded.

* If DISPLAY is set to "ALL," the "●" indication takes priority for steps at which both a bass note and pitch bend data are recorded.

(1) POSITION

This shows the currently selected recording position in “measure:beat:clock” units. You can move the cursor to this indication and use the VALUE dial to specify the measure:beat:clock position, and then strike a key pad to record directly into the specified position.

(2) RANGE

This shows the range of the pitch bend that is recorded at the currently selected position. By moving the cursor to this indication and turning the VALUE dial, you can edit the range of the recorded pitch bend.

Range: 0–12

* If you set RANGE to a setting other than 12, that value will take effect from the bass note at the next recorded location. This means that if you want to record pitch bend data with a RANGE setting other than 12, you’ll need to record a RANGE setting of the desired value and a VALUE setting of 0 at a point earlier than the bass note where you want your setting to take effect.

* RANGE is initialized to 12 at the beginning of the pattern.

(3) VALUE

This shows the value of the pitch bend that is recorded at the currently selected position. By moving the cursor to this indication and turning the VALUE dial, you can edit the value of the recorded pitch bend.

Range: -8192–8191

6. Repeat steps 4–5 if necessary.**7. When you are finished recording, press [EXIT].****8. If you want to save the pattern, proceed to “Saving a pattern” (p. 65).**

<4> Recording a chord progression

Here you can record a chord progression for the bass part.

1. Select the pattern for which you want to record a chord progression.**2. Press [EDIT].**

The edit menu screen appears.

3. Move the cursor to the “PATTERN” icon and press [ENTER].

The pattern edit menu screen appears.

4. Move the cursor to the “CHORD” icon and press [ENTER].

The chord progression recording screen appears.

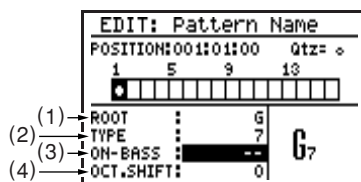
**5. Move the cursor to “Qtz” and use the VALUE dial to specify the quantization.**

The number of grids in each measure of the pattern display area will change according to the quantization you specify. Each square is one step.

Range	
	32nd notes
	16th note triplets
	16th notes
	8th notes triplets
	8th notes
	quarter note triplets
	quarter notes
	whole notes

6. Specify the position at which you want to record a chord.

Use [◀◀] [▶▶] to move the cursor to the step at which you want to record, or use the POSITION measure:beat:clock values to specify the recording position.

Button operations	
[◀]	Moves the recording position to the beginning of the pattern.
[◀◀]	Moves the recording position to the beginning of the preceding step.
[▶▶]	Moves the recording position to the beginning of the next step.
[SHIFT]+ [CURSOR] ▶	Moves to the position at which the next chord is recorded.
[SHIFT]+ [CURSOR] ◀	Moves to the position at which the preceding chord is recorded.
[SHIFT]+ key pad	Deletes the chord recorded at the currently setep.
[SHIFT]+ [EXIT]	Deletes the chord recorded at the currently selected position, and moves to the position at which the next chord is recorded.
[▶]	Starts playback from the beginning of the currently selected measure. Press [■] to stop playback. * If you've turned Arrange "ON" in Pattern Information (p. 53), the arranger will run. If a fill-in (p. 60) is recorded, the fill-in will also be played.

7. Move the cursor to each of the following items, and use the VALUE dial to specify the chord that you want to input.

(1) ROOT

Specify the root note of the chord.
Range: --, C–B

* You can also use the key pads to specify this.

(2) TYPE

Specify the chord type.

Range:

-- (N/C)	Maj	7	M7	m	m7	M9
7(b5)	7(13)	7(b9)	7(#9)	6	6(9)	m6
m6(9)	9	add9	madd9	mM9	mM7	m7(b5)
m9	dim	sus4	7sus4	aug	aug7	

MEMO

-- (N.C: non-chord type)

Choose this type if you don't want the notes of your performance to be converted into a chord. For example, if you specify the Root as "C" and the Chord Type as "--," your original performance data will be played back without change. If you specify the Root as something other than "C," for example as a "D" non-chord type, your original performance data will be played back transposed a whole step higher.

(3) ON-BASS

Specify an on-bass chord (a chord where the bass note is something other than the root of the chord). If you don't want to specify an on-bass chord, set this to "--." Range: --, C–B

* If TYPE is set to "--" (non-chord type), the on-bass chord will be ignored even if you specify it.

(4) OCT. SHIFT

Specify the octave shift setting for the chord.

+1: The chord will be played an octave higher.

0: Octave shift will not be applied. (Normal)

-1: The chord will be played an octave lower.

The results of the ROOT–OCT.SHIFT settings are shown together in the lower right of the screen.

Octave shift is shown as "▲" (+1) or "▼" (-1).

8. Repeat steps 6–7 if necessary.

9. When you're finished recording, press [EXIT].

10. If you want to save the pattern, proceed to "Saving a pattern" (p. 65).

<5> Recording a fill-in

You can choose from a variety of fill-ins and add them to the currently selected pattern.

1. **Select the pattern for which you want to record a fill-in.**

2. **Press [EDIT].**

The edit menu screen appears.

3. **Move the cursor to the “PATTERN” icon and press [ENTER].**

The pattern edit menu screen appears.

4. **Move the cursor to the “FILL” icon and press [ENTER].**

The fill-in record screen appears.

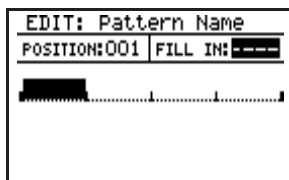

5. **Move the cursor to “POSITION” and use the VALUE dial to select the measure at which you want to record a fill-in.**

6. **Move the cursor to “FILL IN” and use the VALUE dial to select the number of the fill-in that you want to record.**

The name of the selected fill-in is displayed.

Range: s001–s050, L001–L050

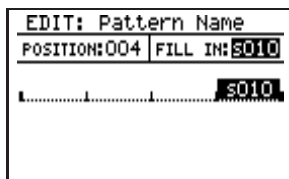

* A fill-in that is longer than the meter can't be placed in the first measure and the next measure after fill-in. (E.g., a fill-in longer than two beats can't be placed in the first measure of a pattern in 2/4 meter.)

Button operations	
[⏪]	Moves the cursor to the beginning of the first measure.
[⏩]	Moves to the preceding measure.
[⏭]	Moves to the next measure.
[SHIFT]+ [EXIT]	Deletes the fill-in from the currently selected measure.
[▶]	Starts playback from the beginning of the currently selected measure. Press [■] to stop playback. * If you've turned Arrange "ON" in Pattern Information (p. 53), the arranger will run. If a fill-in is recorded, the fill-in will also be played.

The measure display area shows the currently selected measure and the number of the fill-in that's recorded at that measure.

7. **Repeat steps 5–6 if necessary.**
8. **When you're finished recorded, press [EXIT].**
9. **If you want to save the pattern, proceed to “Saving a pattern” (p. 65).**

Pattern editing (Pattern Edit)

Copying a portion of a pattern (Copy Measure)

Here's how to copy a portion of the currently selected pattern (or another pattern) into the currently selected pattern.

You can choose whether the original data will be replaced by the copied data, or whether the original data and the copied data will be combined.

● Copying to the same pattern

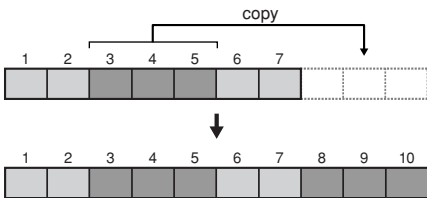

● Copying from a different pattern

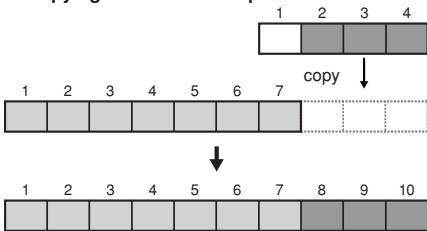

1. In the pattern edit menu screen, move the cursor to the "EDIT" icon and press [ENTER].

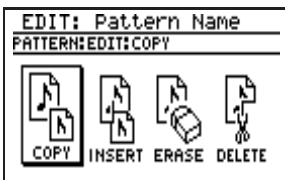

2. Move the cursor to the "COPY" icon and press [ENTER].

The measure copy screen will appear.

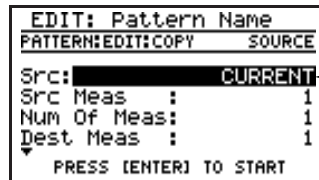

3. Move the cursor to the relevant item, and use the [VALUE] dial to specify the desired value.

Parameter/Range	Explanation
Src	
CURRENT, P001-P500, U001-U500	Copy-source pattern
If you want to copy from the currently selected pattern, set this to "CURRENT."	
Src Meas	
1-n	Starting measure of the copy source
* "n" is the number of measures in the copy source.	
Num of Meas	
1-n	Number of copy-source measures to copy
* "n" is the number of measures in the copy source.	
Dest Meas	
1-(n+1)	Starting measure of the copy destination
* "n" is the number of measures in the current pattern.	
Part	
See below	Type of performance data to be copied
ALL: Drum part and bass part performance data, and chord progressions	
DRUM: Drum part performance data	
BASS: Bass part performance data	
DRUM & BASS: Drum part and bass part performance data	
CHORD: Chord progressions	
Inst	
ALL, 1-01-3-20	If you've set Part to DRUM, specify the instrument(s) to be copied.

Parameter/Range	Explanation
(Ex.) 1-01	StudioKick2
↑ Pad number	↑ Instrument
↑ Pad bank	
<p>Choose from the instruments in the currently selected kit. If you choose ALL, the copy operation will apply to all instruments of the currently selected kit.</p> <p>* You can press a pad to specify the instrument.</p>	
Times	
1-999	Number of times to copy the data
Copy Mode	
REPLACE, MERGE	Specify how the copy is to take place
REPLACE:	
The data at the specified copy destination will be erased before the source data is copied.	
MERGE:	
The data at the specified copy destination will be preserved, and combined with the copied source data.	
* If the Part setting is "CHORD" this parameter will not appear; the Copy operation is performed using only the REPLACE method.	
* If the Part setting is "ALL," the Copy operation will always be performed using REPLACE for the chord progression.	
* Copying with MERGE mode may result in large amounts of overlapping data being recorded at the same location, possibly producing unexpected results during playback.	

- To execute with the specified settings, press [ENTER]. To cancel, press [EXIT]. The message "Now working..." will appear, and the copy will be carried out. When the copy is completed, the message will disappear.
 - If the time signature differs between the copy-source pattern and the currently selected pattern (copy destination), the data will be aligned to the time signature of the currently selected pattern. This will change the number of measures.
 - If you attempt to perform a Copy operation that involves more than 999 measures, the Copy operation will end when the number of measures reaches 999.
 - If the result of the copy operation has increased the number of measures in the pattern, the Measures (p. 53) indication in Patch Information will be updated automatically.
- If you want to save the pattern, proceed to "Saving a pattern" (p. 65).

Inserting blank measures into a pattern (Insert Measure)

Here's how to insert blank measures into the currently selected pattern.

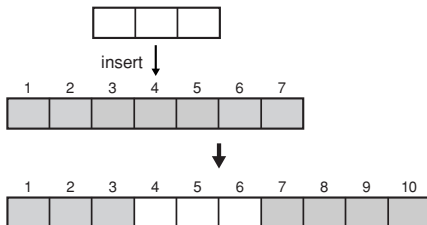

- In the Pattern Edit menu screen, move the cursor to the "EDIT" icon and press [ENTER].

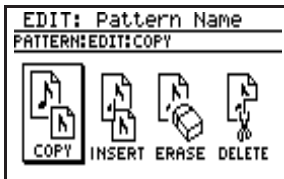

- Move the cursor to the "INSERT" icon and press [ENTER]. The Insert Measure screen will appear.

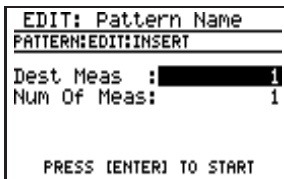

- Move the cursor to each field and use the VALUE dial to set the desired value.

Parameter/Range	Explanation
Dest Meas	
1-(n+1)	Measure at which blank measures are to be inserted
* "n" is the number of measures in the current pattern.	
Num of Meas	
1-(999-n)	Number of blank measures to be inserted

- To insert blank measures as you specified, press [ENTER]. To cancel, press [EXIT]. The message "Now working..." will appear, and the blank measures will be inserted. When the operation has been completed, the message will disappear.

* Since the insert operation will increase the number of measures in the pattern, the Measures (p. 53) indication in Patch Information will be updated automatically.

- If you want to save the pattern, proceed to "Saving a pattern" (p. 65).

Erasing a portion of a pattern (Erase)

Here's how you can erase performance data from the specified portion of the currently selected pattern.

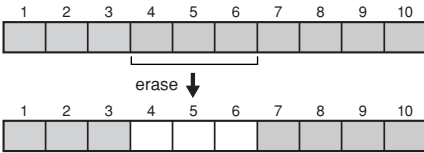

- In the pattern edit menu screen, move the cursor to the "EDIT" icon and press [ENTER].

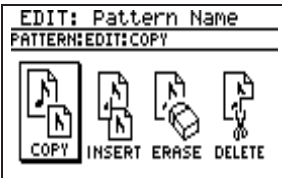

- Move the cursor to the "ERASE" icon and press [ENTER]. The performance data Erase screen will appear.

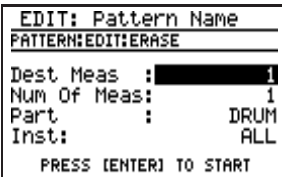

- Move the cursor to the relevant item and use the VALUE dial to specify the desired value.

Parameter/Range	Explanation
Dest Meas	
1-n	Measure at which you want to begin erasing data
* "n" is the number of measures in the current pattern.	
Num of Meas	
1-n	Number of measures to erase
* "n" is the number of measures in the current pattern.	
Part	
See below	Type of data to be erased from the specified measures
ALL: Drum part and chord part performance data, and chord progressions	
DRUM: Drum part performance data	
BASS: Bass part performance data	
DRUM & BASS: Drum part and bass part performance data	
CHORD: Chord progressions	
Inst	
ALL, 1-01-3-20	If you've set Part to DRUM, specify the instruments whose data will be erased.
Choose from the instruments in the currently selected kit.	
If you select ALL, data for all instruments in the currently selected kit will be erased.	
* You can press a pad to specify the instrument.	

- To erase the data you've specified, press [ENTER]. To cancel, press [EXIT]. The message "Now working..." will appear, and the data will be erased. When the erasure has been completed, the message will disappear.
- If you want to save the pattern, proceed to "Saving a pattern" (p. 65).

Deleting unwanted measures (Delete Measure)

Here's how to delete unwanted measures from the currently selected pattern. When the measures have been deleted, the subsequent measures will be moved forward to fill the gap.

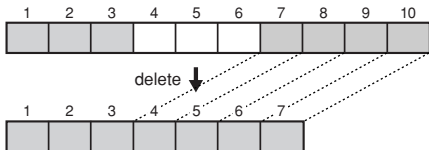

1. In the pattern edit menu screen, move the cursor to the “EDIT” icon and press [ENTER].

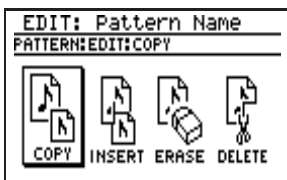

2. Move the cursor to the “DELETE” icon and press [ENTER].

The Delete Measure screen will appear.

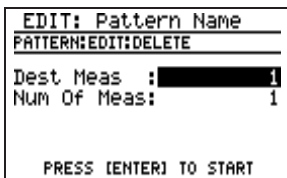

3. Move the cursor to the relevant item and use the VALUE dial to set the desired value.

Parameter/Range	Explanation
Dest Meas	
1-n	Measure at which you want to begin deleting data
* “n” is the number of measures in the current pattern.	
Num of Meas	
1-n	Number of measures to be deleted
* “n” is the number of measures in the current pattern.	

4. To delete the measures you specified, press [ENTER]. To cancel, press [EXIT].
The message “Now working...” will appear, and the measures will be deleted.
When the measures have been deleted, the message will disappear.

* The number of measures in the pattern will decrease when you perform the Delete Measure procedure, and the Measures (p. 53) indication in Pattern Information will be updated automatically.
5. If you want to save the pattern, proceed to “Saving a pattern” (p. 65).

Saving a pattern

If you want to keep a pattern you've created or edited, you must carry out the "Write" operation to write (store) the pattern into a user pattern memory location.

NOTE

If you re-select a pattern or turn off the power before Writing, your edited pattern data will be lost.

Naming a pattern (Pattern Name)

You can assign a name (pattern name) of up to fourteen characters to your pattern.

1. In the pattern edit menu screen, move the cursor to the "NAME" icon and press [ENTER].

The pattern name edit screen appears.



2. Move the cursor to the place where you want to input a character, and use the VALUE dial to choose a character.

Button operations	
[CURSOR] ◀ [CURSOR] ▶	Move the cursor.
[CURSOR] ▲	Switch from lowercase to uppercase characters.
[CURSOR] ▼	Switch from uppercase to lowercase characters.
[SHIFT]+ [CURSOR] ▶	Insert a space at the cursor location.
[SHIFT]+ [CURSOR] ◀	Delete the character at the cursor location, and shift subsequent characters to the left.

3. When you've finished specifying the name, press [EXIT].
4. Proceed with "Writing your pattern."

Writing your pattern

1. In the pattern edit menu screen, move the cursor to the "WRITE" icon and press [ENTER].

The pattern write screen appears.

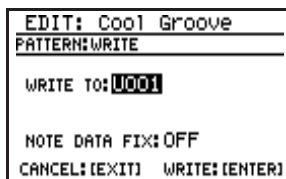

2. Use the VALUE dial to select the user pattern into which you want to write your pattern.
3. Move the cursor to "NOTE DATA FIX" and use the VALUE dial to turn it on/off.

NOTE DATA FIX

This specifies how the pattern will be saved when you create a pattern with the Pattern Information setting Arrange (p. 53) turned ON.

ON:

The pattern will be saved with the performance data (bass) as it was converted by the Arrange function. If you execute Write with this setting ON, the Pattern Information setting Arrange will automatically be turned OFF.

- * If you save with NOTE DATA FIX turned on, and then turn the pattern information Arrange setting on, the pattern (to which Arrange has been applied) will once again be processed by the Arrange function, possibly producing unexpected results.

OFF:

The pattern will be saved without being processed by the arranger.

4. To write your pattern, press [ENTER]. If you decide not to write it, press [EXIT].

The message "Now writing..." will appear, and the pattern will be saved. When the pattern has been saved, the message will disappear.

- * Do not turn off the power while the message is displayed. Your data may be damaged if you do so.

Copying/Erasing a pattern

Copying a pattern

1. In the pattern edit menu screen, move the cursor to the “COPY” icon and press [ENTER].

* If there is an edited pattern that has not been saved, the message “Cancel edit?” will appear.

If you want to save the pattern, press [EXIT] and perform the Write operation (p. 65). If you don't want to save it, press [ENTER].

The pattern copy screen appears.

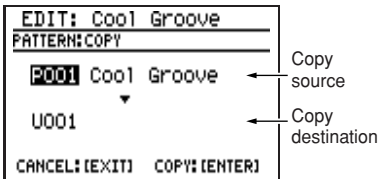

2. Move the cursor to the copy-source pattern number, and use the VALUE dial to select a pattern.
3. Move the cursor to the copy-destination pattern number, and use the VALUE dial to select a user pattern.
4. To execute the copy, press [ENTER]. If you decide to cancel, press [EXIT].

The message “Now writing...” will appear, and the copy will be carried out.

When the copy is completed, the message will disappear.

* Do not turn off the power while the message is displayed. Your data may be damaged if you do so.

Erasing a pattern

1. Select the pattern that you want to erase.

* It is not possible to erase the preset pattern.

2. Press [EDIT].

The edit menu screen appears.

3. Move the cursor to the “PATTERN” icon and press [ENTER].

The pattern edit menu screen appears.

4. Move the cursor to the “CLEAR” icon and press [ENTER].

The screen will ask “Clear pattern?”

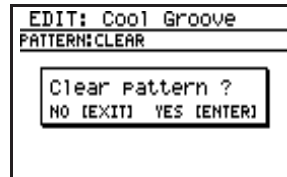

5. If you are sure you want to clear (erase) the pattern, press [ENTER]. If you decide to cancel, press [EXIT].

The message “Now writing...” will appear, and the pattern will be erased.

When the erasure has been completed, the message will disappear.

* Do not turn off the power while the message is displayed. Your data may be damaged if you do so.

Chapter 3

EZ Compose/ Groove Modify

What is EZ Compose?

“EZ Compose” is a group of functions that lets you create a pattern simply by making a few settings in the screen—you don’t have to input each individual note of the rhythm. You can also add a chord progression and fill-ins.

What is Groove Modify?

“Groove Modify” functions lets you change the “groove” (rhythmic feel) of the pattern playback.

Groove Modify includes the following three functions.

- **Velocity Modify**
- **Ghost Note**
- **Shuffle**

Using EZ Compose

You can use EZ Compose in Pattern mode, but not in Song mode (p. 75).

Creating a pattern

EZ Compose lets you select a favorite pattern for each group of sounds, and combine them to create your new pattern.

NOTE

EZ Compose creates patterns with a time signature of 4/4 or 3/4.

If the time signature of the currently selected pattern is not one of these, it will be converted to 4/4 or 3/4.

1. Press EZ COMPOSE [PATTERN].

- * If there is an edited pattern that has not been saved, the message "Cancel edit?" will appear. If you want to save the pattern, press [EXIT] and perform the Write operation (p. 65). If you don't want to save it, press [ENTER].

The EZ Compose pattern setting screen appears.

EZ COMPOSE: PATTERN		
BEAT: 4/4	MEAS: 4	KIT: P001
	TYPE	No.
HH CYM:	██████████	1
KICK SHR:	-----	1
PERC :	-----	1
BASS :	-----	1

2. Move the cursor to the relevant item, then use the VALUE dial to set the value.

Parameter/Range	Explanation
BEAT	
4/4, 3/4	Time signature
MEAS	
1-32	Number of measures
KIT	
P001-P100, U001-U100	Number of the kit to use
TYPE/No.: HH CYM	
see below	Preset patterns for hi-hat/cymbals
Type: 8BEAT, 16BEAT, SHUFFLE, 1/2SHUFFLE	
TYPE/No.: KICK SNR	
see below	Preset patterns for kick/snare
Type: 8BEAT, 16BEAT, SHUFFLE, 1/2SHUFFLE	
TYPE/No.: PERC	
see below	Preset patterns for percussion
Type: ROCK POPS, CONGA BONGO, SLOW LATIN, LATIN POPS	
TYPE/No.: BASS	
see below	Preset patterns for bass
Type: STEADY&SIMPL, ROCK BLUES, BALLAD, FUNK SOUL	

- * If you want to use the currently selected pattern, choose "Current" as the TYPE.
- * Choose "-----" as the TYPE for patterns that you don't want to use (i.e., that you want to remain silent).

Press [▶] to play the pattern with the current settings.

3. If you want to save the pattern, proceed to "Saving a pattern" (p. 65).

Adding a chord progression

Here's how to select a favorite chord progression from various preset chord progressions, so that the bass part will play according to the progression you selected.

1. Press EZ COMPOSE [CHORD PROGRESSION].

* If there is an edited pattern that has not been saved, the message "Cancel edit?" will appear.

If you want to save the pattern, press [EXIT] and perform the Write operation (p. 65). If you don't want to save it, press [ENTER].

The EZ Compose chord progression setting screen appears.

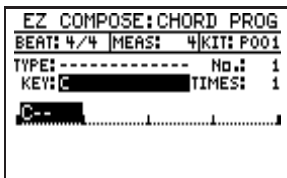

2. Move the cursor to the relevant item, then use the VALUE dial to set the value.

Parameter/ Range	Explanation
KIT	
P001–P100, U001–U100	Number of the kit to use
TYPE/No.	
see below	Type and number of the preset chord progressions
Type: 2MEAS Maj, 2MEAS Min, 4MEAS Maj, 4MEAS Min, 8MEAS Maj, 8MEAS Min, 16MEAS Maj, 16MEAS Min, BLUES Maj, BLUES Min, USER PATTERN	
* If you want to use chord progression of the currently selected pattern, choose "Current" as the TYPE.	
* If you choose "-- -----," the chord progression setting will not be used.	
* If you choose "USER PATTERN," the chord progression of the specified user pattern will be used.	
* If you choose "Current" or "USER PATTERN," the key and the chord progression may not match if the Key (p. 53) of the specified pattern is not set correctly.	
KEY	
C–B, Cm–Bm	Key for playback
* The chord progression will be key-shifted according to the KEY setting.	
TIMES	
1–32	Number of times to repeat the selected chord progression
* It is not possible to set MEAS beyond 32 measures.	

* MEAS (number of measures) is determined automatically by the TYPE/No. and TIMES settings. You cannot directly change the number of measures.

The screen shows the chord progression you specified.

If you want, you can press [DISPLAY] to change the amount of information about the chord progression that is displayed at once; the available choices are: "4 measures x 3 lines," "2 measures x 3 lines," or "1 measure x 3 lines."

Press [▶] to play the pattern with the current settings.

3. If you want to save the pattern, proceed to "Saving a pattern" (p. 65).

Adding a fill-in

You can choose from a variety of fill-ins and add them to the currently selected pattern.

1. Press EZ COMPOSE [FILL IN].

* If there is an edited pattern that has not been saved, the message "Cancel edit?" will appear.

If you want to save the pattern, press [EXIT] and perform the Write operation (p. 65). If you don't want to save it, press [ENTER].

The EZ Compose fill-in setting screen appears.

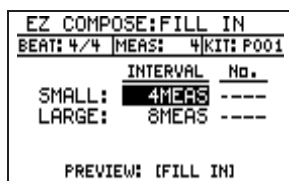

2. Move the cursor to the relevant item, then use the VALUE dial to set the value.

Parameter/ Range	Explanation
KIT	
P001–P100, U001–U100	Number of the kit to use
SMALL: INTERVAL	
1–32MEAS	Specify the number of measures after which a Small (short) fill-in will be added
(Example) If you set this to 4MEAS, a small fill-in will be added at measure 4, measure 8, measure 12, ... etc.	
* If the number of measures specified by INTERVAL is greater than the number of measures in the pattern, the fill-in will not be played.	
SMALL: No.	
---, s001–s050, L001–L050	Number of preset (Small fill-in) to use
* If you choose "---" the Small fill-in will not be added.	
LARGE: INTERVAL	
1–32MEAS	Specify the number of measures after which a Large (long) fill-in will be added
(Example) If you set this to 16MEAS, a Large fill-in will be added at measure 16, 32, 48, ... etc.	
* If the number of measures specified by INTERVAL is greater than the number of measures in the pattern, the fill-in will not be played.	
LARGE: No.	
---, s001–s050, L001–L050	Number of preset (Large fill-in) to use
* If you choose "---" the Large fill-in will not be added.	
* If the Small fill-in and Large fill-in occur at the same measure, the Large fill-in will take priority.	

Press [▶] to play the pattern with the current settings.

Press [FILL IN], you can play only the measures within which a fill-in occurs.

If the number of measures specified by INTERVAL is greater than the number of measures in the pattern, the measure at which the fill-in occurs will not be played.

3. If you want to save the pattern, proceed to "Saving a pattern" (p. 65).

Using Groove Modify

You can use Groove Modify in Pattern mode, but not in Song mode (p. 75).

Applying volume changes (Velocity Modify)

Here's how you can add accents and expression to the pattern to create realistic dynamics, just as in an actual drum performance.

1. Select a pattern (p. 50).
2. Press [GROOVE].

The groove modify menu screen appears.

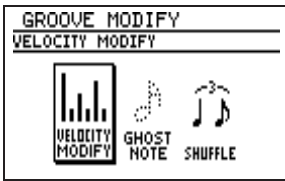

3. Move the cursor to the "VELOCITY MODIFY" icon and press [ENTER].

The velocity modify setting screen appears.

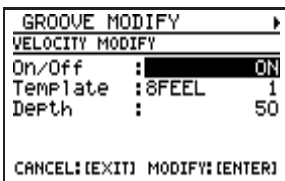

4. Move the cursor to the relevant item, then use the VALUE dial to set the value.

Parameter/Range	Explanation
On/Off	
OFF, ON	Turn Velocity Modify on/off
* You can also press [GROOVE] to turn this on/off.	
Template	
8FEEL 1-8, 16FEEL 1-12	Number of the template you want to use

Parameter/Range	Explanation
Depth	
0-100	Depth with which Velocity Modify is applied
With a setting of 0, Velocity Modify will not be applied.	
* In case of using only velocity balance, set the depth 0.	

Changing the volume balance (Velocity Balance)

Here's how to change the volume balance by adjusting the volume (velocity) of each note in a pattern independently for each sound group (hi-hat/cymbals, kick, snare, percussion, and bass).

5. Press [CURSOR] ▷.

The Velocity Balance setting screen appears.

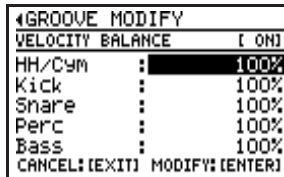

6. Move the cursor to each item, and use the VALUE dial to set the value.

Parameter/Range	Explanation
On/Off	
OFF, ON	Turn Velocity Modify on/off
* You can press [GROOVE] to turn this on/off.	
HH/Cym	
0-150%	Adjust the volume of the hi-hat/cymbals
Kick	
0-150%	Adjust the volume of the kick
Snare	
0-150%	Adjust the volume of the snare
Perc	
0-150%	Adjust the volume of the percussion
BASS	

Parameter/ Range	Explanation
0–150%	Adjust the volume of the bass
A setting of 0% will make the sound extremely faint. With a setting of 100%, the velocity will be as specified in the pattern. Settings of 101% or higher will make the velocity higher than specified in the pattern.	

- To execute with the specified settings, press [ENTER]. To cancel, press [EXIT].
- If you want to save the pattern, proceed to “Saving a pattern” (p. 65).

Adding ghost notes

By adding “ghost notes” to the pattern you can create a realistic sense of groove, just as in an actual drum performance.

- Select a pattern (p. 50).
- Press [GROOVE].
The groove modify menu screen appears.

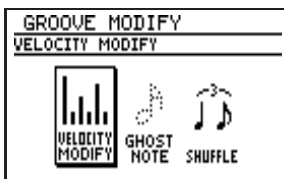

- Move the cursor to the “GHOST NOTE” icon and press [ENTER].
The ghost note setting screen appears.

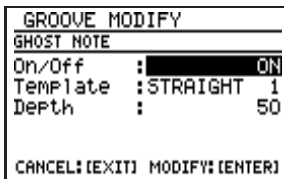

- Move the cursor to the relevant item, then use the VALUE dial to set the value.

Parameter/ Range	Explanation
On/Off	
OFF, ON	Turn Ghost Note on/off
* You can also press [GROOVE] to turn this on/off.	
Template	
see below	Number of the template that you want to use
STRAIGHT 1–20: These are appropriate for straight patterns.	
SHUFFLE 1–20: These are appropriate for shuffle patterns.	
Depth	
0–100	Volume of the ghost notes

- To execute with the specified settings, press [ENTER]. To cancel, press [EXIT].
- If you want to save the pattern, proceed to “Saving a pattern” (p. 65).

Creating a shuffle rhythm

You can create a “shuffle” rhythm by shifting the timing at which the backbeats of the pattern are played.

1. Select a pattern (p. 50).
2. Press [GROOVE].

The groove modify menu screen appears.

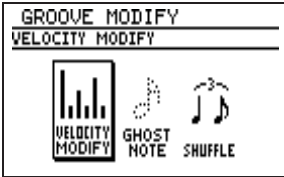

3. Move the cursor to the “SHUFFLE” icon and press [ENTER].

The shuffle setting screen appears.

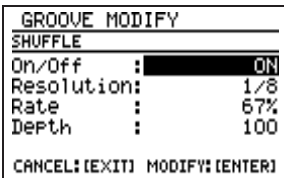

4. Move the cursor to the relevant item, then use the VALUE dial to set the value.

Parameter/Range	Explanation
On/Off	
OFF, ON	Turn Shuffle on/off
* You can also press [GROOVE] to turn this on/off.	
Resolution	
1/8, 1/16	Shuffle playback timing
1/8: Shuffle will be generated in units of eighth notes.	
1/16: Shuffle will be generated in units of sixteenth notes.	
1/8	
1/16	

Parameter/Range	Explanation
Rate	
50–100%	Amount of backbeat shuffle
Specifies how far the backbeats will be distanced from the downbeats. With a setting of 50%, the backbeats will be located exactly midway between the timing of adjacent downbeats. With a setting of 100%, the backbeats will be located at the same timing as the next downbeat.	
50%	
75%	
90%	
backbeat backbeat backbeat backbeat	
Depth	
0–100	Amount by which the backbeats will be adjusted relative to the value determined by Rate
With a setting of 100, the notes will be moved all the way to the timing specified by Rate. Lowering the Depth setting will decrease the amount of adjustment that is applied; with a Depth of 0, the notes will not be adjusted at all.	

5. To execute with the specified settings, press [ENTER]. To cancel, press [EXIT].
6. If you want to save the pattern, proceed to “Saving a pattern” (p. 65).

MEMO

Chapter 4

Song

(record/edit/play)

You'll use Song mode to record, edit, and play songs.

With the Play screen displayed and playback stopped, press [SONG/PATTERN] so "SONG" appears in the display.

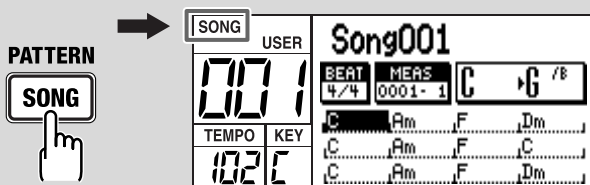

Recording a song

To record a song, you use “step recording” to specify each pattern in the desired playback order.

- You can record up to 100 songs.
- One song can contain up to 500 patterns, and all songs can together contain a total of 50,000 patterns.

Before you begin recording

Here’s the procedure for recording a song.

<1> Select the user song you want to record

<2> Make basic settings for the song

<3> Step-record the song

<1> Selecting the user song you want to record

1. Access the Song Play screen.
2. Use the VALUE dial to select a user song (001–100).

TIP

You can also erase a song that’s been previously recorded and use that location. Refer to “Clearing (erasing) a song” (p. 80).

<2> Making basic settings for the song

Here’s how to make basic settings for the song.

* You can also change these settings after recording.

1. In the Song Play screen, press [EDIT].
The edit menu screen appears.
2. Move the cursor to the “SONG” icon and press [ENTER].
The song edit menu screen appears.

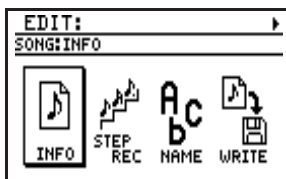

3. Move the cursor to the “INFO” icon and press [ENTER].
The song information screen appears.

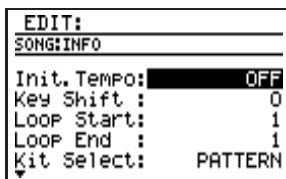

4. Move the cursor to the parameter you want to edit, and use the VALUE dial to edit the value.

Parameter / Value	Explanation
Init.Tempo	
OFF, 20–260	Tempo setting for the song
OFF: The song will play at the tempo specified by each pattern.	
20–260: The tempo specified by each pattern will be ignored, and the song will play at the tempo you specify here.	

Parameter / Value	Explanation
Key Shift	
-12+12	Transpose the playback key in semitone steps
* The key indication at the left side of the display shows the playback key resulting from the Key Shift setting. (Example) If Key (pattern) = Am and Key Shift = +, this is displayed as "Bm."	
Loop Start	
1-n	The measure number from which loop playback (p. 82) will start
* 'n' will be the number of measures specified for the song.	
Loop End	
1-n	The measure number at which loop playback will end
* 'n' will be the number of measures specified for the song.	
Kit Select	
SONG, PATTERN	Select the kit used to play the song
SONG: The kit specified by each pattern will be ignored; the kit you specify for Kit Number will be used throughout the entire song.	
PATTERN: The kit specified by each pattern will be used.	
Kit Number	
P001-P100, U001-U100	The number of the kit used to play this song
TSC Select	
SONG, PATTERN	Select the TSC patch used when playing this song
SONG: The TSC patch specified by each pattern will be ignored; the TSC patch you specify for TSC Number will be used throughout the entire song.	
PATTERN: The TSC patch specified by each pattern will be used.	
TSC Switch	
OFF, ON	TSC on/off setting
TSC Number	
P01-P20, U01-U20	The number of the TSC patch to use

- 5. When you're finished editing, press [EXIT].**

<3> Step-recording your song

- 1. In the song edit menu screen, move the cursor to the "STEP REC" icon and press [ENTER].**

The song step recording screen appears.

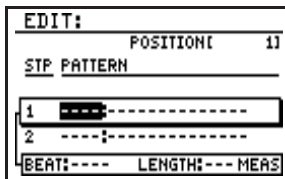

- 2. Use the VALUE dial to select the first pattern you want to record in your song.**
The screen shows the time signature (BEAT) and number of measures (LENGTH) in the selected pattern.

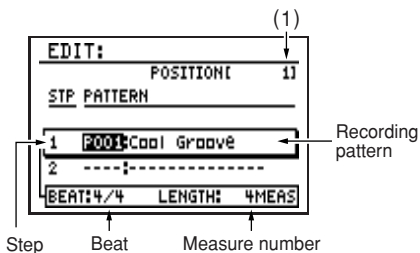

- 3. Press [▶▶] to advance to the next step, and use the VALUE dial to select the next pattern you want to record in your song.**

* You can't advance to the next step by skipping over an unrecorded step.

(1) POSITION

This indicates the position within the song of the first measure of the pattern you've selected for the step currently targeted for editing.

Press [◀◀] to return to step 1.

Press [◀◀] to return to the preceding step.

Hold down [SHIFT] and press [▶▶] to advance to an unrecorded step.

4. Repeat step 3 as many times as necessary.

- You can insert a pattern at an already-recorded step; refer to “Inserting a pattern in the song.”
- You can delete an already-recorded pattern; refer to “Deleting a pattern.”

* You can't record, or insert or delete patterns while a song is playing. In order to perform these operations, you must first stop song playback.

5. When you're finished recording, press [EXIT].

6. To save the song, proceed as described in “Saving your song” (p. 79).

■ Inserting a pattern in the song

Here's how to insert a pattern into the middle of the song.

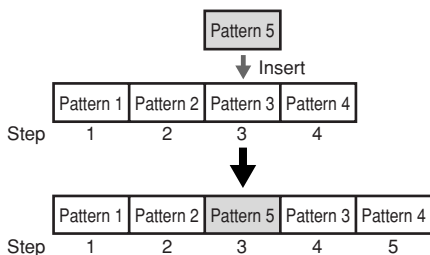

1. In the song step record screen, use [◀◀][▶▶] to select the step at which you want to insert a pattern

2. Hold down [SHIFT] and press [ENTER].

A new step will be inserted, and subsequent steps will move backward by one step.

The inserted step will have the same pattern as selected for the step you selected in step 1.

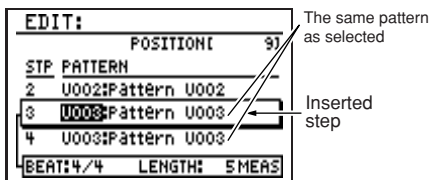

3. Use the VALUE dial to select the desired pattern for the newly inserted step.

■ Deleting a pattern

Here's how to delete an unwanted pattern from the song. When you delete a pattern, subsequent patterns will be moved forward.

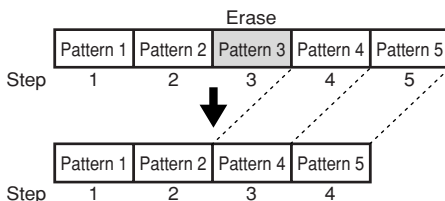

1. In the song step record screen, use [◀◀][▶▶] to select the step from which you want to delete a pattern.

2. Hold down [SHIFT] and press [ERASE] ([EXIT]).

The pattern recorded at the selected step will be deleted.

Saving your song

If you want to save a song you recorded or edited, you must “Write” it as a user song.

NOTE

If you re-select the song or turn off the power before executing the Write procedure, your song data will be lost.

Naming your song (Song Name)

You can give your song a name of up to fourteen characters.

1. In the song edit screen, move the cursor to the “NAME” icon and press [ENTER].
The song name edit screen appears.

```
EDIT: _____
SONG:NAME _____
NAME: █ _____
[ \ ] ^ _ ` ( ) ~ * ABCDEFGHIJ
          *
DEL: [SHIFT]+[4] CAPS: [▲][▼]
INS: [SHIFT]+[▶]
```

2. Move the cursor to the location at which you want to input a character, and use the VALUE dial to select the desired character.

Button operations	
[CURSOR] ▷ [CURSOR] ◁	Move the cursor.
[CURSOR] △	Switch from lowercase to uppercase characters.
[CURSOR] ▽	Switch from uppercase to lowercase characters.
[SHIFT]+ [CURSOR] ▷	Insert a space at the cursor location.
[SHIFT]+ [CURSOR] ◁	Delete the character at the cursor location, and shift subsequent characters to the left.

3. When you've finished inputting the name, press [EXIT].
4. Then continue to “Writing your song.”

Writing your song

1. In the song edit menu screen, move the cursor to the “WRITE” icon and press [ENTER].

The song write screen appears.

```
EDIT: Song001
SONG:WRITE _____
WRITE TO: 0001
CANCEL: [EXIT] WRITE: [ENTER]
```

2. Use the VALUE dial to select the user song number into which you want to write your song.

3. To write your song into memory, press [ENTER]. If you decide to cancel, press [EXIT].

The message “Now writing...” will appear, and the song will be saved.

When the song have been saved, the message will disappear.

* Do not turn off the power while the message is displayed. Your data may be damaged if you do so.

Copying/Clearing a song

Copying a song

1. In the song edit menu screen, move the cursor to the “COPY” icon and press [ENTER].

* If there is an edited song that has not been saved, the message “Cancel edit?” will appear.
If you want to save the song, press [EXIT] and perform the Write operation (p. 79). If you don't want to save it, press [ENTER].

The song copy screen appears.

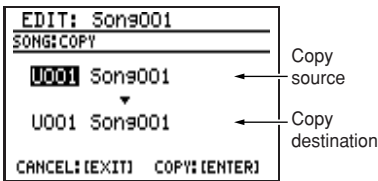

2. Move the cursor to the copy-source song number, and use the VALUE dial to select a song number.
3. Move the cursor to the copy-destination song number, and use the VALUE dial to select a user song as the copy destination.
4. To copy the song, press [ENTER]. If you decide to cancel, press [EXIT].

The message “Now writing...” will appear, and the copy will be carried out. When the copy is completed, the message will disappear.

* Do not turn off the power while the message is displayed. Your data may be damaged if you do so.

Clearing (erasing) a song

1. Select the song that you want to clear.
2. Press [EDIT].
The edit menu screen appears.
3. Move the cursor to the “SONG” icon and press [ENTER].
The song edit menu screen appears.
4. Move the cursor to the “CLEAR” icon and press [ENTER].

The display will ask “CLEAR SONG?”

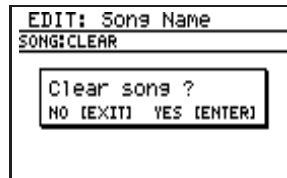

5. To clear the song, press [ENTER]. If you decide to cancel, press [EXIT].

The message “Now writing...” will appear, and the song will be erased.

When the erasure has been completed, the message will disappear.

* Do not turn off the power while the message is displayed. Your data may be damaged if you do so.

Playing a song

1. Access the song play screen.
2. Use the VALUE dial to select the song you want to play.

* If there is an edited song that has not been saved, the message "Cancel edit?" will appear.

If you want to save the song, press [EXIT] and perform the Write operation (p. 79). If you don't want to save it, press [ENTER].

3. Press [▶].

The song you selected will start playing.

- You can turn the VALUE dial during playback to reserve the song to be played next. The name of the reserved song is highlighted.

When the current song finishes playing, the reserved song will start playing.

4. To stop playback, press [■].

- If you press [▶] once again, playback will resume from where you stopped.
- If you press [◀] and then [▶], playback will start from the beginning of the song.

Changing the tempo

You can change the tempo during playback. However, the way in which the tempo changes will depend on the "Init. Tempo" (p. 76) setting of the Song Information screen.

If Init.Tempo is OFF:

The pattern that is playing when you press [TEMPO (TAP)] will change to the altered tempo. When the next pattern is reached, it is played at its predetermined tempo.

If Init.Tempo is something other than OFF:

The playback tempo of the song will change to the tempo you specified.

1. Press [TEMPO (TAP)].

The tempo edit screen appears.

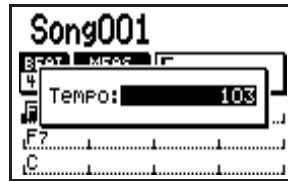

2. Use the VALUE dial to adjust the tempo.

You can adjust the tempo in a range of 20–260.

* After a short while, you will automatically return from the tempo setting screen to the previous screen.

■ Using Tap Tempo to set the tempo

You can specify the tempo by pressing [TEMPO (TAP)] at the desired interval. This function is called "Tap Tempo."

1. Press [TEMPO (TAP)] four or more times at the desired tempo.

The tempo will be set to the interval at which you press the button, and the current tempo is shown in the tempo edit screen.

* After a short while, you will automatically return from the tempo setting screen to the previous screen.

Changing the playback key

You can change the key (pitch) at which the song plays. This function is called “Key Shift.”

1. Press [KEY].

The key shift edit screen appears.

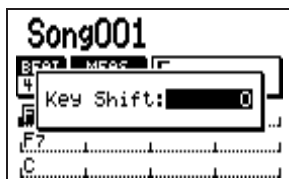

2. Use the VALUE dial to change the key.

Range: -12+12

You can change the key in semitone steps over a range of ± 1 octave.

* After a short while, you will automatically return from the key shift setting screen to the previous screen.

Looping the playback in a specified region

You can make the playback loop (continue repeating) in the region of measures you specify.

1. In the song play screen, press [EDIT].

The edit menu screen appears.

2. Move the cursor to the “SONG” icon and press [ENTER].

The song edit menu screen appears.

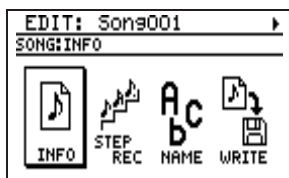

3. Move the cursor to the “INFO” icon and press [ENTER].

The song information screen appears.

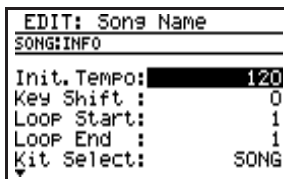

4. Move the cursor to “Loop Start,” and use the VALUE dial to specify the measure number at which loop playback is to start.

5. Move the cursor to “Loop End,” and use the VALUE dial to specify the measure number at which loop playback is to end.

6. Press [EXIT] several times to return to the song play screen.

7. Press [LOOP] to make the button light (Loop on).

8. Press [▶].

The song will start playing, and will loop over the specified region of measures.

9. To stop loop playback, press [LOOP] to make the button go dark (Loop off).

10. To stop playback, press [■].

11. If you want to save the loop playback setting, carry out the “Writing your song” (p. 79) procedure.

NOTE

When you delete unwanted patterns from a song, causing the number of measures in the song to become less than the Loop End measure number you specified, the Loop End setting will remain unchanged.

In this case, loop playback won't occur even though you've pressed [LOOP] and illuminated the button; you will need to change the Loop End setting.

Switching the display

You can switch the song play screen between the “chord progression display” (four measures x 3/ two measures x 3/ one measure x 3) and the “playback pattern display.”

1. Press [DISPLAY].

Press the button repeatedly to cycle through the available choices for the display, as follows:

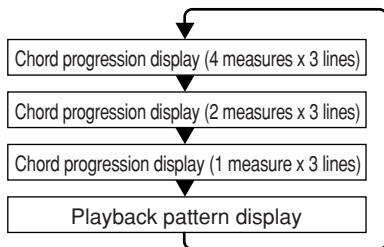

■ Chord progression display

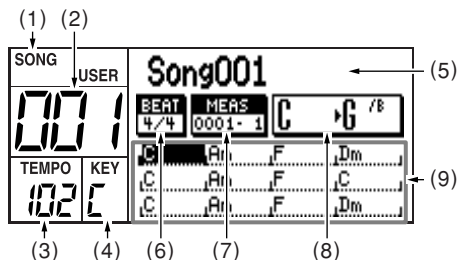

(1) Song mode

(2) Song number

(3) Current tempo

(4) Current key

(5) Song name

An “*” shown before the song name indicates that the song has been edited.

(6) Time signature

(7) Measure – Beat

This indicates the current location.

(8) Current chord → Next chord

The current chord and next chord will be displayed in greater detail.

(9) Chord progression

The cursor will move with the playback, indicating the currently playing measure.

You can press [DISPLAY] to select the type of chord progression display area that you want, either “4 measures x 3 lines,” “2 measures x 3 lines,” or “1 measure x 3 lines.” Viewing fewer measures at a time will let you see the chord progression in greater detail.

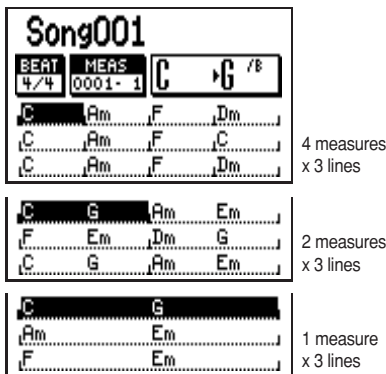

■ Playback pattern display

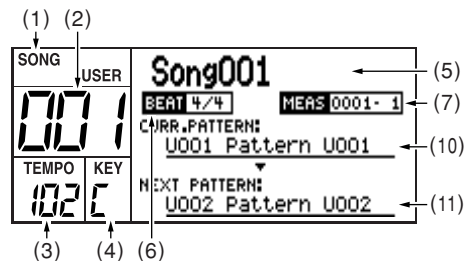

(10) Current pattern

This indicates the currently playing pattern (number/name).

(11) Next pattern

This indicates the pattern (number/name) that will play next.

MEMO

Chapter 5

Playing your guitar/bass

Connecting your guitar/bass

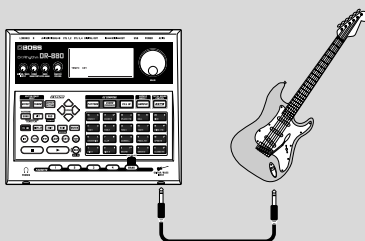

Adjusting the volume of your guitar/bass

Use the GUITAR/BASS INPUT knob to adjust the volume.



The trademarks listed in this document are trademarks of their respective owners, which are separate companies from BOSS. Those companies are not affiliated with BOSS and have not licensed or authorized BOSS's DR-880. Their marks are used solely to identify the equipment whose sound is simulated by BOSS's DR-880.

Using effects

Switching effect patches

1. Press [EFFECT].

The guitar effects edit screen appears.

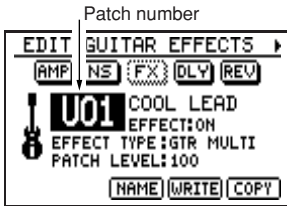

2. Move the cursor to the effect patch number, and use the VALUE dial to select the desired effect patch number.

* You can hold down [SHIFT] and press [EFFECT] to switch between Preset (P) and User (U).

cf.

“Effect Patch” (p. 155)

Editing an effect patch (Patch Edit)

1. In the guitar effects edit screen, move the cursor to one of the items below and use the VALUE dial to edit the value.

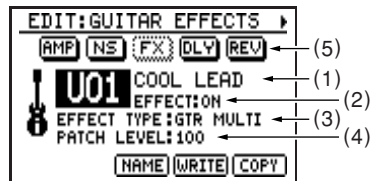

(1) Effect patch

Select the effect patch that you want to edit.

(2) Effect on/off

The guitar effects will be switched on/off each time you press [EFFECT].

(3) EFFECT TYPE (Algorithm)

Select the algorithm you want to use.

Range:

GTR MULTI, BASS MULTI, ACO MULTI

(4) PATCH LEVEL

Specify the volume of the effect patch.

Range: 0–100

(5) Effect block diagram (algorithm)

You can move the cursor to each effect and turn the VALUE dial to switch the effect on/off. Effects that are turned off are shown with dotted lines.

If you move the cursor to an effect and press [ENTER], the parameter edit screen for the selected effect will appear.

Press [CURSOR] ▷ to switch the screen.

Parameter edit screen

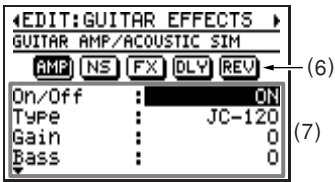

(6) Effect block diagram (algorithm)

Use [CURSOR] ◀ / ▶ to switch to the parameter edit screen for the effect at the cursor location.

(7) Parameters

Move the cursor to the parameter you want to edit, and use the VALUE dial to change the value.

You can use [CURSOR] ▲ / ▼ to scroll the parameter display.

2. When you have made the setting, press [EXIT] to return to the guitar effects edit screen.

In order to indicate that the effect settings have been temporarily changed, the patch number will be displayed as “*TMP.” If you re-select an effect patch, or turn off the DR-880 while “*TMP” is being displayed, all of the patch settings will return to their previous condition. As it may not be possible to restore these settings, the appropriate care should be taken.

3. If you want to keep the changes you made, proceed as described in “Saving/Copying an Effect patch” (p. 88).

* If you want to name the effect patch or edit the name, proceed to “Naming an effect patch” (p. 88) before you save.

Saving/Copying an Effect patch

If you want to save an effect patch you created or edited, you must “Write” it as a user patch.

NOTE

If you re-select an effect patch or turn off the power before executing the Write procedure, your patch data will be lost.

Naming an effect patch

You can assign a name (Patch Name) of up to twelve characters to each user patch.

1. In the guitar effects edit screen, move the cursor to “NAME” and press [ENTER].

The patch name edit screen appears.

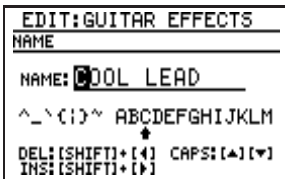

2. Move the cursor to the location at which you want to input a character, and use the VALUE dial to select the desired character.

Button operations	
[CURSOR] ▷ [CURSOR] ◁	Move the cursor.
[CURSOR] △	Switch from lowercase to uppercase characters.
[CURSOR] ▽	Switch from uppercase to lowercase characters.
[SHIFT]+ [CURSOR] ▷	Insert a space at the cursor location.
[SHIFT]+ [CURSOR] ◁	Delete the character at the cursor location, and shift subsequent characters to the left.

3. When you've finished entering the name, press [EXIT].
4. Then continue to “Writing an effect patch.”

Writing an effect patch

Here's how to save an effect patch you edited.

1. In the guitar effects edit screen, move the cursor to “WRITE” and press [ENTER]. The effect patch write screen appears.

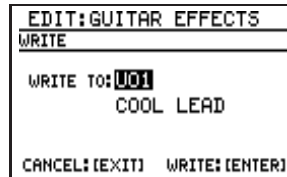

2. Use the VALUE dial to select the write-destination user patch.
3. To write the patch, press [ENTER]. If you decide to cancel, press [EXIT].

The message “Now writing...” will appear, and the effect patch will be written. When the effect patch have been written, the message will disappear.

* Do not turn off the power while the message is displayed. Your data may be damaged if you do so.

Copying an effect patch

1. In the guitar effects edit screen, move the cursor to “COPY” and press [ENTER].

The effect patch copy screen appears.

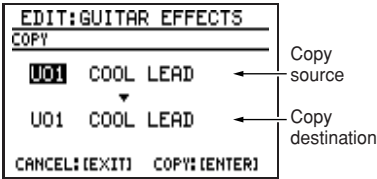

2. Move the cursor to the copy-source patch number, and use the VALUE dial to select the patch number you want to copy from.
3. Move the cursor to the copy-destination patch number, and use the VALUE dial to select the patch number you want to copy to.
4. To execute the copy, press [ENTER].
If you decide to cancel, press [EXIT].

The message “Now writing...” will appear, and the copy will be carried out.

When the copy is completed, the message will disappear.

* Do not turn off the power while the message is displayed.
Your data may be damaged if you do so.

Using the Tuner/Expression pedal

Tuning your guitar/bass

The DR-880 contains a chromatic tuner that you can use to tune your guitar/bass connected to the GUITAR/BASS INPUT jack.

1. Press [TUNER].

The tuner screen appears.

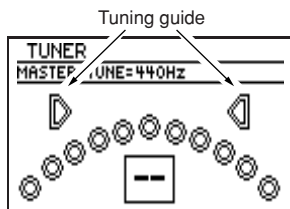

2. Play a single note on the string you want to tune.

The display shows the name of the note closest to the pitch of the string you played.

* *Cleanly play a single note on just the string you are tuning.*

3. Tune your instrument so that the correct note is shown for the string you're tuning.

(Typical tuning for each string)

	7th	6th	5th	4th	3rd	2nd	1st
Guitar	B	E	A	D	G	B	E
Bass			B	E	A	D	G

4. Watch the tuning guide, and tune your instrument so that both left and right indicators are lit.

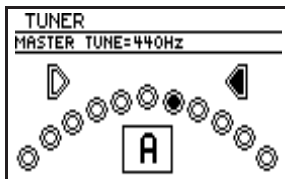

When the pitch is higher than the Displayed note

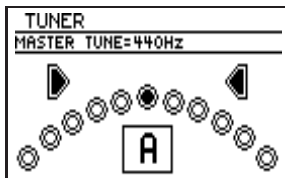

When the pitch matches the Displayed note

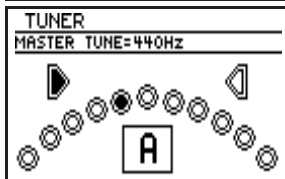

When the pitch is lower than the Displayed note

5. Repeat steps 2–4 to tune the remaining strings.

* *If you're tuning a guitar that has a vibrato arm, tuning one string may cause other strings to drift. First tune the strings approximately so that the correct note names are displayed. Then continue tuning each string until they are all correct.*

6. When you have tuned all of strings, press [EXIT].

■ Changing the reference pitch of the tuner

* The reference pitch of the tuner is shared with the DR-880's master tune setting (p. 120).

1. In the pattern or song play screen, press [EDIT]

The edit menu screen appears.

2. Move the cursor to the "MASTER TUNE" icon, and press [ENTER].

The master tune setting screen appears.

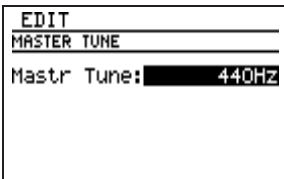

3. Use the VALUE dial to adjust the setting.

Range: 435 Hz–445 Hz

4. When you've made the setting, press [EXIT].

The message "Now writing..." will appear, and the currently settings will be saved. When the currently settings have been saved, the message will disappear.

* Do not turn off the power while the message is displayed. Your data may be damaged if you do so.

Using an expression pedal as a volume pedal

When you connect an expression pedal (such as the Roland EV-5; sold separately) to the rear panel's CTL 3, 4/EXP PEDAL jack, you will be able to control the volume of your guitar/bass that is connected to the GUITAR/BASS INPUT jack using your feet.

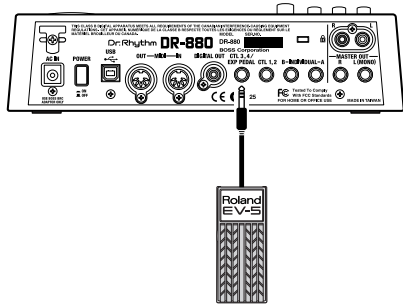

- Use only the specified expression pedal (EV-5; sold separately). By connecting any other expression pedals, you risk causing malfunction and/or damage to the unit.
- Both the Roland EV-5 have a minimum volume setting of 0.

MEMO

If you've selected an effect patch that uses pedal wah (P-WAH: p. 94), the expression pedal will automatically function as a wah pedal.

Guitar effects parameter list

GTR MULTI (Guitar multi)

AMP **NS** **FX** **DLY** **REV**

Effect	Page	
GUITAR AMP/ACOUSTIC SIM	p. 93	
NOISE SUPPRESSOR	p. 93	
FX	COMPRESSOR	p. 94
	A-WAH	p. 94
	P-WAH	p. 94
	CHORUS	p. 94
	PHASER	p. 95
	FLANGER	p. 95
	TREMOLO	p. 95
PAN	p. 95	
DELAY	p. 96	
REVERB	p. 96	

■ FX

Parameter/Range	Explanation
On/Off	
OFF, ON	Switches FX on/off
FX Select	
COMPRESSOR, A-WAH, P-WAH, CHORUS, PHASER, FLANGER, TREMOLO, PAN	Choose one effect to use

BASS MULTI

CMP **AMP** **NS** **FX** **DLY**

Effect	Page	
COMPRESSOR	p. 96	
BASS AMP SIM	p. 97	
NOISE SUPPRESSOR	p. 93	
FX	T-WAH	p. 97
	P-WAH	p. 94
	CHORUS	p. 94
	PHASER	p. 95
	FLANGER	p. 95
	TREMOLO	p. 95
	PAN	p. 95
DELAY	p. 96	

■ FX

Parameter/Range	Explanation
On/Off	
OFF, ON	Switches FX on/off
FX Select	
T-WAH, P-WAH, CHORUS, PHASER, FLANGER, TREMOLO, PAN	Choose one effect to use

ACO (Acoustic) MULTI

ACO **EQ** **CHO** **REV**

Effect	Page
ACOUSTIC PROCESSOR	p. 98
EQUALIZER	p. 98
CHORUS	p. 94
REVERB	p. 96

Description of the effects

■ GUITAR AMP/ACOUSTIC SIM (Guitar amp/Acoustic simulator)

COSM technology is used to simulate the response of various guitar amps or the sound of an acoustic guitar.

Parameter/Range	Explanation
On/Off	
OFF, ON	Switches GUITAR AMP/ACOUSTIC SIM on/off
Type	
See below	Choose a guitar amp or acoustic simulator
JC-120	The sound of a Roland JC-120
WARM CLEAN	A mellow, clean sound
CLEAN TWIN	Models a Fender Twin Reverb
TWEED	Models a Fender Bassman 4 x 10" Combo
CRUNCH	Crunch sound with a natural-sounding distortion
VO DRIVE	Models the driven sound of a VOX AC-30TB
MATCH DRIVE	Models the left input sound of a Matchless D/C-30
BG LEAD	Models the lead sound of a MESA/Boogie combo amp
SMOOTH Drv	A smooth driven sound
MS1959 (I)	Models input I of a Marshall 1959
MS HiGAIN	Models the sound of a Marshall with modified midrange boost
POWER STACK	The sound of an amp stack with an active tone circuit
R-FIER RED	Models the RED channel of a MESA/Boogie DUAL Rectifier
T-AMP Crnch	Models AMP2 of a Hughes & Kettner Triamp
T-AMP LEAD	Models AMP3 of a Hughes & Kettner Triamp
SLDN	Models a Soldano SLO-100
LEAD STACK	A high-gain lead sound
5150 DRIVE	Models the lead channel of a Peavey EVH5150
METAL STACK	A drive sound good for metal
Single->AC	Transforms the sound of a single-coil pickup electric guitar into the sound of an acoustic guitar

Parameter/Range	Explanation
Humbckr->AC	Transforms the sound of a humbucking pickup electric guitar into the sound of an acoustic guitar
Gain	
0-100	Amount of amp distortion
Bass	
0-100	Low-range tone
Middle	
0-100	Midrange tone
Treble	
0-100	High-range tone
Presence	
0-100	Ultra-high-range tone
Level	
0-100	Volume of the entire preamp
* Be careful not to raise Level excessively.	

■ NOISE SUPPRESSOR

This effect suppresses the noise and hum that are picked up by a guitar pickup. Since it reduces the noise in a way that matches the envelope (the volume change over time) of the guitar sound, it provides natural-sounding noise suppression without significantly affecting the guitar sound.

Parameter/Range	Explanation
On/Off	
OFF, ON	Switches NOISE SUPPRESSOR on/off
Threshold	
0-100	Depth at which the noise suppressor is applied
Set this to a higher value if there is a lot of noise, or to a lower value if there is not too much noise.	
* If you set the Threshold to a high value, the sound may be cut off when you play with the volume of your guitar turned low.	



■ COMPRESSOR: GTR MULTI

This effect produces long sustain by making the volume of the input signal more uniform. You can also use this as a “limiter” to prevent distortion by holding down just the peaks of the sound.

Parameter/Range	Explanation
Sustain	
0–100	Adjusts the duration of time over which low-level input signals will be boosted to a steady volume
Higher settings of this parameter will produce longer sustain.	
Level	
0–100	Volume of the effect sound

■ A-WAH (Auto wah)

This effect automatically creates a wah effect by sweeping a filter in a fixed pattern.

Parameter/Range	Explanation
Polarity	
UP, DOWN	Specifies the direction that the filter moves in response to the input
UP: The filter will move toward a higher frequency.	
DOWN: The filter will move toward a lower frequency.	
Sens	
0–100	Specifies the sensitivity of the filter movement
Freq	
0–100	Center frequency of the wah effect
Peak	
0–100	Depth of the wah effect in the region of the center frequency
Higher values produce a stronger tone which emphasizes the wah effect more. A setting of “50” produces the typical wah sound.	
Rate	
0–100, BPM  -BPM 	Auto wah rate (speed)
* If you set this to BPM, the effect will synchronize to the tempo of the pattern. If this produces a cycle that is too fast, the effect will synchronize to 1/2 or 1/4 of the actual BPM.	

Parameter/Range	Explanation
Depth	
0–100	Depth of the wah effect
Level	
0–100	Volume of the effect sound

■ P-WAH (Pedal wah)



This effect produces the sound of a wah pedal.

* If an expression pedal (Roland EV-5; sold separately) is connected to the rear panel CTL3, 4/EXP PEDAL jack, the expression pedal will function as a wah pedal.

Parameter/Range	Explanation
Level	
0–100	Volume of the effect sound



■ CHORUS

This effect creates a beautifully rich and spacious sound by adding a slightly pitch-modulated sound to the sound of the guitar or bass.

Parameter/Range	Explanation
Rate	
0–100, BPM  -BPM 	Effect modulation rate
* If you set this to BPM, the effect will synchronize to the tempo of the pattern. If this produces a cycle that is too fast, the effect will synchronize to 1/2 or 1/4 of the actual BPM.	
Depth	
0–100	Depth of the effect
E.Level	
0–100	Volume of the chorus sound



■ PHASER

By adding a phase-shifted version of the guitar sound, this effect creates a phase shifting effect that gives a twisting, turning character to the sound.

Parameter/Range	Explanation
Rate	
0–100, BPM  -BPM 	Speed of rotation
* If you set this to BPM, the effect will synchronize to the tempo of the pattern. If this produces a cycle that is too fast, the effect will synchronize to 1/2 or 1/4 of the actual BPM.	
Depth	
0–100	Depth of rotation
Manual	
0–100	Center frequency at which the phase shift effect is applied
Resonance	
0–100	Intensity of the effect's quirkiness



■ FLANGER

This produces a flanging effect that can produce a swishing, jet-like modulation.

Parameter/Range	Explanation
Rate	
0–100, BPM  -BPM 	Effect modulation rate
* If you set this to BPM, the effect will synchronize to the tempo of the pattern. If this produces a cycle that is too fast, the effect will synchronize to 1/2 or 1/4 of the actual BPM.	
Depth	
0–100	Depth of modulation
Manual	
0–100	Center frequency at which the effect is applied
Resonance	
0–100	Strength of tonal character



■ TREMOLO

This effect cyclically varies the volume.

Parameter/Range	Explanation
Rate	
0–100, BPM  -BPM 	Effect modulation rate
* If you set this to BPM, the effect will synchronize to the tempo of the pattern. If this produces a cycle that is too fast, the effect will synchronize to 1/2 or 1/4 of the actual BPM.	
Depth	
0–100	Effect depth



■ PAN

This effect alternately varies the volume of the left and right channels, producing the impression that the sound is moving between the left and right speakers when you listen in stereo.

Parameter/Range	Explanation
Wave Shape	
0–100	Adjusts the volume change
Rate	
0–100, BPM  -BPM 	Rate of volume change
* If you set this to BPM, the effect will synchronize to the tempo of the pattern. If this produces a cycle that is too fast, the effect will synchronize to 1/2 or 1/4 of the actual BPM.	
Depth	
0–100	Depth of volume change

■ DELAY

This adds a delayed version of the guitar/bass sound, making the sound richer or creating a distinctive echo-like effect.

Parameter/Range	Explanation
On/Off	
OFF, ON	Delay on/off
Time	
0–1200ms, BPM  -BPM 	Delay time
* If you set this to BPM, the effect will synchronize to the tempo of the pattern. If this produces a delay time that is too long, the effect will synchronize to a multiple of two times or four times the actual BPM.	
Feedback	
0–100	The degree to which the delayed sound will repeat
E.Level	
0–120	Volume of the delay sound

■ REVERB

This effect adds reverberation to the sound.

Parameter/Range	Explanation
On/Off	
OFF, ON	Reverb on/off
Type	
ROOM, HALL, PLATE	Reverb type
ROOM: This simulates the acoustical properties of a room, producing a warm reverberation.	
HALL: This simulates the acoustical properties of a concert hall, producing a clear and spacious reverberation.	
PLATE: This simulates a plate reverb unit (a device using a vibrating metal plate), producing a metallic reverberation with an extended high-frequency range.	
Time	
0.1–10.0 sec	Length of the reverberation
Tone	
-50+50	Tonal character of the reverberation
E.Level	
0–100	Volume of the reverberation

■ COMPRESSOR: BASS MULTI

This effect produces long sustain by making the volume of the input signal more uniform. You can also use this as a “limiter” to prevent distortion by holding down just the peaks of the sound. This effect also helps to make the sound more consistent

Parameter/Range	Explanation
ON/OFF	
OFF, ON	Comp on/off
Threshold	
0–100	Volume at which the compressor begins to operate
Ratio	
1:1.00, 1:1.12, 1:1.25, 1:1.40, 1:1.60, 1:1.80, 1:2.00, 1:2.50, 1:3.20, 1:4.00, 1:5.60, 1:8.00, 1:16.0, 1:INF	Compression ratio
Attack	
0–100	Strength of the attack when you pluck a string
Release	
0–100	Time from when the signal falls below the specified Threshold level until when the compressor is no longer applied
Level	
0–100	Volume after the sound passes through the compressor

■ BASS AMP SIM (Bass amp simulator)

This uses COSM technology to simulate the response of various bass amps.

Parameter	Range
On/Off	
OFF, ON	Switches BassAmpSim on/off
Type	
See below	The type of bass amp
CONCERT 810	Models an Ampeg SVT
SESSION	Models an SWR SM-400
BASS 360	Models an Acoustic 360
T.E.	Models a Trace Elliot AH600SMX
B-MAN	Models a Fender Bassman 100
FLIP TOP	Models an Ampeg B-15
BASS CLEAN	A clean sound
BASS CRUNCH	Crunch sound with a natural-sounding distortion
BASS HiGAIN	High-gain sound
FLAT	Flat response
Gain	
0–100	Amount of amp distortion
Bass	
0–100	Low-range tone
Middle	
0–100	Midrange tone
Treble	
0–100	High-range tone
Presence	
0–100	Ultra-high-range tone
Level	
0–100	Overall volume of the amp

■ T-WAH (Touch wah)

This effect controls a filter according to the volume of the bass being input. It produces a distinctive sound in which the filter follows your playing.

Parameter/ Range	Explanation
Polarity	
Up, Down	Specifies the direction that the filter moves in response to the input
Up: The filter will move toward a higher frequency.	
Down: The filter will move toward a lower frequency.	
Sens	
0–100	Sensitivity of the filter movement
Freq	
0–100	Center frequency of the wah effect
Peak	
0–100	Depth of the wah effect in the region of the center frequency
Setting this parameter to a low value will produce a wah effect over a wide range around the center frequency. Setting this parameter to a high value will produce a wah effect in a narrow range around the center frequency. A setting of "50" produces the typical wah sound.	
Level	
0–100	Volume of the effect sound

■ ACOUSTIC PROCESSOR

This effect can be applied to the sterile-sounding output from the pickup of an electro-acoustic guitar, giving it a richer character typical of sound recorded through a mic.

Parameter/ Range	Explanation
On/Off	
OFF, ON	Switches ACOUSTIC PROCESSOR on/off
Low	
-50-0+50	Adjusts the tone for the low frequency range.
High	
-50-0+50	Adjusts the tone for the high frequency range.
Level	
0-100	Adjusts the volume of the acoustic processor.

■ EQUALIZER

This is a three-band equalizer.

Parameter/ Range	Explanation
On/Off	
OFF, ON	Switches EQUALIZER on/off
Low	
-20+20 dB	Low-range tone
Mid	
-20+20 dB	Midrange tone
High	
-20+20 dB	High-range tone
Level	
-20+20 dB	Volume of the sound before passing through the equalizer

Chapter 6

Editing the TSC settings

You can edit the settings of the “stereo three-band equalizer” and “ambience/reverb” provided by the TSC section, and store these settings as one of twenty user patches.

TSC patch editing

Edit procedure

1. Press [TSC].

The TSC patch edit screen appears.

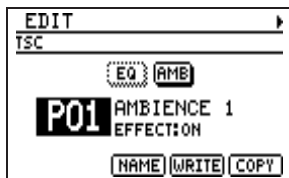

2. Move the cursor to the TSC patch number, and select the TSC patch that you want to edit.

* You can hold down [SHIFT] and press [TSC] to switch between Preset (P) and User (U).

* Each time you press [TSC], TSC will turn on or off.

* You can turn each effect on/off by moving the cursor to "EQ" or "AMP" and turning the VALUE dial. Effects that are off are shown in dotted lines.

You can access the editing screen for each effect by moving the cursor to "EQ" or "AMB" and pressing [ENTER].

3. Use [CURSOR] </> to access the stereo EQ edit screen or the ambience/reverb edit screen.

Stereo EQ edit screen

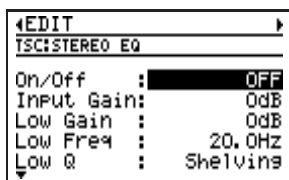

Ambience/Reverb edit screen

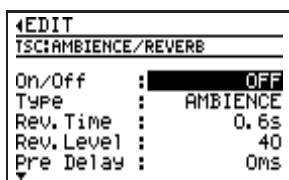

4. Move the cursor to the parameter you want to edit, and use the VALUE dial to edit the value.

5. When you have made the setting, press [EXIT] to return to the TSC patch edit screen.

In order to indicate that the TSC patch settings have been temporarily changed, the patch number will be displayed as "*TMP." If you re-select a TSC patch, or turn off the DR-880 while "*TMP" is being displayed, all of the patch settings will return to their previous condition. As it may not be possible to restore these settings, the appropriate care should be taken.

6. If you want to keep the changes you made, proceed to "Saving/Copying a TSC patch" (p. 103).

* If you want to name a TSC patch or modify its name before saving, proceed as described in "Naming a TSC patch" (p. 103) first.

■ Stereo equalizer parameters

Parameter/Range	Explanation
On/Off	
OFF, ON	Stereo EQ on/off
Input Gain	
-20→+20 dB	Overall volume of the sound before it passes through the equalizer
Low Gain	
-20→+20dB	Low range boost/cut amount
Low Freq	
20.0 Hz–12.5 kHz	Low range center frequency
Low Q	
Shelving, 0.5–16	Switch to a shelving-type EQ, or adjust the steepness of the response curve around the center frequency of the Low equalizer
Mid Gain	
-20→+20 dB	Mid range boost/cut amount
Mid Freq	
20.0 Hz–20.0 kHz	Mid range center frequency
Mid Q	
0.5–16	Steepness of the response curve around the center frequency of the Mid equalizer
High Gain	
-20→+20 dB	High range boost/cut amount
High Freq	
400 Hz–20.0 kHz	High range center frequency
High Q	
Shelving, 0.3–16.0	Switch to a shelving-type EQ, or adjust the steepness of the response curve around the center frequency of the High equalizer

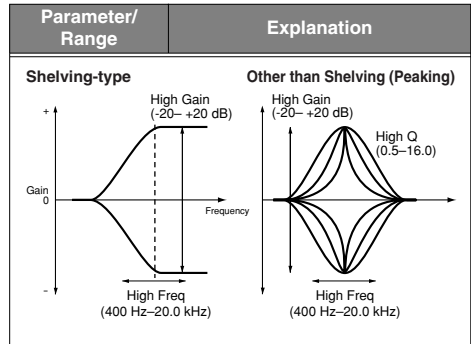

■ Ambience/Reverb parameters

Parameter/Range	Explanation
On/Off	
OFF, ON	AMBIENCE/REVERB on/off
Type	
see below	Ambience/Reverb type
AMBIENCE:	
Simulates an ambience mic (placed in an "off-mic" location at a distance from the sound source) used in recording.	
ROOM:	
Simulates the reverberation of a room.	
HALL:	
Simulates the reverberation of a concert hall.	
PLATE:	
Simulates the reverberation of a plate reverb (a reverb unit using a metal plate).	
Rev Time	
0.1–10.0 s	Length of the reverb sound
Rev.Level	
0–100	Volume of the reverb sound
Pre Delay	
0–20 ms	Time from when sound is input until reverb is output
Low Cut Freq	
Flat, 55.0 Hz–2.00 kHz	Frequency at which the low cut filter begins to take effect
If you choose Flat, the low cut filter will do nothing.	
High Cut Freq	
700 Hz–20.0 kHz, Flat	Frequency at which the high cut filter begins to take effect
If you choose Flat, the high cut filter will do nothing.	

Parameter/ Range	Explanation
Size	
1-10	Size of the room being simulated
ER Level	
0-100	Volume of the early reflections
Density	
0-100	Density of the early reflections
Rel Density	
0-100	Density of the late reverberation
Low Damp	
0.10-1.00	Attenuation of the late reverberation's low-frequency range
L. Damp Freq	
55 Hz-4.00 kHz	Frequency at which the low-frequency region of the late reverberation begins to be attenuated
The late reverberation in the region below the L. Damp Freq setting will be attenuated.	
High Damp	
0.10-1.00	Attenuation of the late reverberation's high-frequency range
H. Damp Freq	
400 Hz-20.0 kHz	Frequency at which the high-frequency region of the late reverberation begins to be attenuated
The late reverberation in the region above the H. Damp Freq setting will be attenuated.	

Saving/Copying a TSC patch

If you want to save a TSC patch you created or edited, you must “Write” it as a user patch.

NOTE

If you re-select a TSC patch, change pattern or song, or turn off the power before executing the Write procedure, your patch data will be lost.

Naming a TSC patch

You can assign a name (patch name) of up to twelve characters to each user patch.

1. In the TSC patch edit screen, move the cursor to “NAME” and press [ENTER].

The patch name edit screen appears.

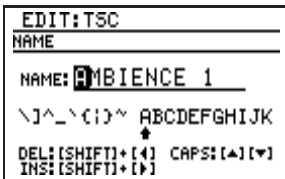

2. Move the cursor to the location at which you want to input a character, and use the VALUE dial to choose a character.

Button operations	
[CURSOR] ▷ [CURSOR] ◁	Move the cursor.
[CURSOR] △	Switch from lowercase to uppercase characters.
[CURSOR] ▽	Switch from uppercase to lowercase characters.
[SHIFT]+ [CURSOR] ▷	Insert a space at the cursor location.
[SHIFT]+ [CURSOR] ◁	Delete the character at the cursor location, and shift subsequent characters to the left.

3. When you’ve finished specifying the name, press [EXIT].
4. Then continue to “Writing a TSC patch.”

Writing a TSC patch

Here’s how to save an edited TSC patch.

1. In the TSC patch edit screen, move the cursor to “WRITE” and press [ENTER]. The TSC patch edit screen appears.

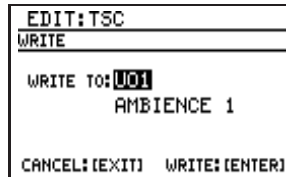

2. Use the VALUE dial to select the write-destination user patch.
3. To write the patch, press [ENTER]. If you decide to cancel, press [EXIT].

The message “Now writing...” will appear, and the TSC patch will be saved.

When the TSC patch have been saved, the message will disappear.

- * Do not turn off the power while the message is displayed. Your data may be damaged if you do so.

Copying a TSC patch

1. In the TSC patch edit screen, move the cursor to “COPY” and press [ENTER].

The TSC patch copy screen appears.

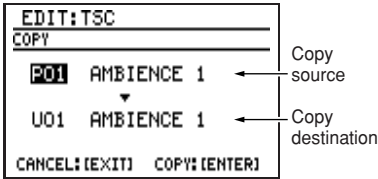

2. Move the cursor to the copy-source patch number, and use the VALUE dial to select the patch number you want to copy from.
3. Move the cursor to the copy-destination patch number, and use the VALUE dial to select the patch number you want to copy to.
4. To execute the copy, press [ENTER].
If you decide to cancel, press [EXIT].

The message “Now writing...” will appear, and the copy will be carried out.

When the copy is completed, the message will disappear.

* Do not turn off the power while the message is displayed.
Your data may be damaged if you do so.

Chapter 7

Creating an original kit (Kit Edit)

Kit Edit lets you choose sounds and make settings for the drum part and for the bass part, and store your original kit in one of the 100 user kit memories.

Editing a kit

Here's the procedure for editing a kit.

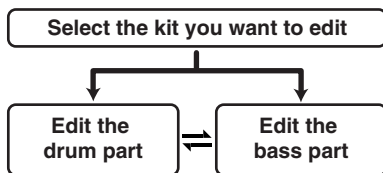

* When shipped from the factory, the user kits contain the same settings as the preset kits.

Selecting the kit you want to edit

1. Press [KIT].

The kit edit screen appears.



2. Move the cursor to the kit number, and use the VALUE dial to select the kit you want to edit.

* You can hold down [SHIFT] and press [KIT] to switch between Preset (P) and User (U).

3. Select the part you want to edit.

To edit the drum part, move the cursor to "DRUM PART" and press [ENTER].

To edit the bass part, move the cursor to "BASS PART" and press [ENTER].

4. Proceed to "Editing the drum part" or "Editing the bass part."

Editing the Drum part

1. Use [CURSOR] < / > to select the desired edit screen.
2. Move the cursor to the parameter you want to edit, and use the VALUE dial to edit the value.

* To hear the sounds, strike key pads 1–20 or play back a pattern.

3. When you have made the setting, press [EXIT] to return to the kit edit screen.

In order to indicate that the kit settings have been temporarily changed, the kit number will be displayed as "*TMP." If you re-select a kit, or turn off the DR-880 while "*TMP" is being displayed, all of the kit settings will return to their previous condition. As it may not be possible to restore these settings, the appropriate care should be taken.

4. If you want to keep the changes you made, proceed to "Saving/Copying a kit" (p. 113).

* If you want to assign a name to your kit or edit the name before saving, proceed as described in "Naming a kit" (p. 113) before you save the kit.

■ PART COMMON (Settings common to both parts)

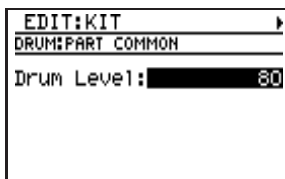

Parameter/Range	Explanation
Part Level	
0–100	Volume of the drum part

■ PAD (Edits for each key pad (Pad Parameters))

←EDIT:KIT →	
DRUM:PAD	BANK1 No. 1
Inst:013	Stdiokick2
Level :	90
Pan :	CENTER
Rev. Send :	20
Out Assign:	IFX<KICK>

To select the key pad you want to edit, proceed as follows:

1. Press [PAD] to switch the pad bank.
2. Press the desired key pad 1–20.

Parameter/Range	Explanation
Inst	
see p. 151	Select the sound (instrument) assigned to the key pad
Level	
0–100	Adjust the volume of the instrument
Pan	
L50–CENTER–R50	Adjust the panning
* This is valid if Out Assign is set to MASTER, IFX (OTHERS), or IND. A+B	
* If Out Assign is set to IFX (KICK/SNARE), use the reverb send level of the insert effect (p. 108) to make adjustments.	
Rev.Send	
0–100	Depth of reverb applied to each instrument
* This is valid only if Out Assign is set to MASTER.	
Out Assign	
see below	Select the output destination for the sound of each instrument, or the insert effect to be used
MASTER: The sound will be output from the MASTER OUT jacks without being processed by an insert effect.	
IFX (KICK): The sound will be processed by the Kick insert effect. The output destination will be as specified by the Out Assign setting of the insert effect (p. 108).	
IFX (SNARE): The sound will be processed by the Snare insert effect. The output destination will be as specified by the Out Assign setting of the insert effect (p. 108).	

Parameter/Range	Explanation
IFX (OTHERS): The sound will be processed by the Others insert effect. The output destination will be as specified by the Output Assign setting of the insert effect (p. 108).	
IND. A: The sound will be output from the INDIVIDUAL A jack.	
IND. B: The sound will be output from the INDIVIDUAL B jack.	
IND. A+B: The sound will be output from both INDIVIDUAL A and B jacks.	
Mute Group	
OFF, 1–31	Specifies how the unit is to sound when you play consecutive notes with one or more instruments
OFF: When you play instruments consecutively, the previous sound will continue while the newly played sound is heard.	
1–31: Instruments that are set to the same Mute Group number will not sound simultaneously. This is typically used for instruments that cannot normally sound at the same time, such as open hi-hat and closed hi-hat.	
Pit. Coarse	
-50–0–+50	Coarse pitch adjustment
+ values: The greater the value, the higher the pitch. A setting of +1 raises the pitch one semitone.	
0: The instrument will sound at its original pitch.	
- values: The greater the value, the lower the pitch. A setting of -1 lowers the pitch one semitone.	
* On some instruments, the pitch may not change correctly for positive (+) settings.	
Pitch Fine	
-50–+50	Fine pitch adjustment
Decay Time/ Rel. Time/Decay Lev	
0–127	These parameters specify how the volume changes over time, from when the instrument is played until the sound decays to silence. This is referred to as the “envelope.”

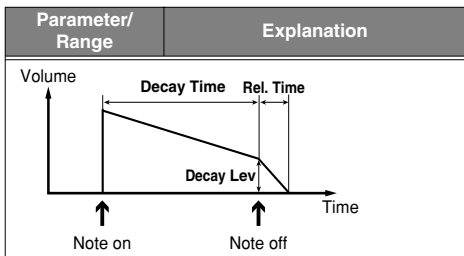

INS. FX

Three separate effects—KICK, SNARE, and OTHERS—are provided for the instruments.

* *The KICK and SNARE effects are monaural, and OTHERS is stereo.*

KICK, SNARE



OTHERS

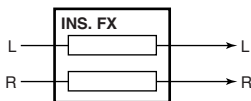

COMMON (Common settings)

(Example) For INS. FX: KICK



Parameter/Range	Explanation
Pan (for KICK/SNARE)	
L50-CENTER-R50	Panning of the KICK/SNARE
* <i>This is valid only if Out Assign is set to MASTER or IND. A+B.</i>	
* <i>The OTHERS effect does not have this parameter.</i>	
Rev. Send	
0-100	Reverb depth

Parameter/Range	Explanation
Out Assign (for KICK/SNARE)	
see next	Output destination for the sound
MASTER: The sound will be output from the MASTER OUT jacks.	
IND. A: The sound will be output from the INDIVIDUAL A jack.	
IND. B: The sound will be output from the INDIVIDUAL B jack.	
IND. A+B: The sound will be output from both INDIVIDUAL A and B jacks.	
Out Assign (for OTHERS)	
see below	Output destination for the sound
MASTER: The sound will be output from the MASTER OUT jacks.	
IND. A+B: The sound will be output from both INDIVIDUAL A and B jacks.	

EQ (Equalizer)

This is a three-band parametric equalizer. Low and High regions can be switched to shelving type.

(Example) For INS. FX: KICK

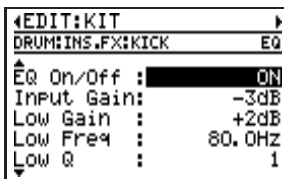

Parameter/Range	Explanation
EQ On/Off	
OFF, ON	EQ on/off
Input Gain	
-20+20 dB	Overall volume of the sound before it passes through the equalizer
Low Gain	
-20+20 dB	Low range boost/cut amount

Parameter/Range	Explanation
Low Freq	
20 Hz–12.5 kHz	Low range center frequency
Low Q	
Shelving, 0.5–16	Switch to a shelving-type EQ, or adjust the steepness of the response curve around the center frequency of the Low equalizer
Mid Gain	
-20–+20 dB	Midrange boost/cut amount
Mid Freq	
20 Hz–20.0 kHz	Midrange center frequency
Mid Q	
0.5–16	Steepness of the response curve around the center frequency of the Mid equalizer
High Gain	
-20–+20 dB	High range boost/cut amount
High Freq	
400 Hz–20.0 kHz	High range center frequency
High Q	
Shelving, 0.5–16	Switch to a shelving-type EQ, or adjust the steepness of the response curve around the center frequency of the High equalizer

COMP (Compressor)

This effect compresses the volume of the input signal. It can also be used as a limiter to suppress only the peaks in order to prevent distortion.

(Example) For INS. FX: KICK

EDIT:KIT	
DRUM:INS.FX:KICK	COMP
CMP On/Off:	OFF
Threshold :	60
Ratio :	1:1.60
Attack :	80
Release :	50

Parameter/Range	Explanation
Cmp On/Off	
OFF, ON	COMP on/off
Threshold	
0–100	Volume at which the compressor begins to operate
Ratio	
1:1.00–1:16.0, 1:INF	Compression ratio
Attack	
0–100	Time from when the input level exceeds the specified Threshold level until the compressor begins to operate
Release	
0–100	Time from when the signal falls below the specified Threshold level until the compressor is no longer applied
Level	
0–100	Volume of the signal after passing through the compressor

Editing the Bass part

1. Use [CURSOR] </> to select the desired edit screen.
2. Move the cursor to the parameter that you want to edit, and use the VALUE dial to edit the value.
3. When you have made the setting, press [EXIT] to return to the kit edit screen.

In order to indicate that the kit settings have been temporarily changed, the kit number will be displayed as “*TMP.” If you re-select a kit, or turn off the DR-880 while “*TMP” is being displayed, all of the kit settings will return to their previous condition. As it may not be possible to restore these settings, the appropriate care should be taken.

4. If you want to keep the changes you made, proceed as described in “Saving/Copying a kit” (p. 113).

* If you want to assign a name to the kit or edit the name before saving the kit, proceed as described in “Naming a kit” (p. 113).

■ PART COMMON (Common settings)

EDIT:KIT
BASS:PART COMMON
Tone:001 FingerBs 1
Level : 80
Pan : CENTER
Rev. Send : 0
Out Assign: IFX(BASS)

Parameter/ Range	Explanation
Tone	
See p. 153	Select the bass sound
Level	
0–100	Volume of the bass part
Pan	
L50–CENTER– R50	Panning of the bass part
* This is valid only if Out Assign is set to MASTER or IND. A+B.	
Rev. Send	
0–100	Reverb depth
* This is valid only if Out Assign is set to MASTER.	
Out Assign	
see below	Select the output destination for the sound, or the insert effect to be used
MASTER: The sound will be output from the MASTER OUT jacks.	
IFX (BASS): The sound will be processed by the Bass insert effect. The output destination will be as specified by the Out Assign setting of the insert effect (p. 111).	
IND. A: The sound will be output from the INDIVIDUAL A jack.	
IND. B: The sound will be output from the INDIVIDUAL B jack.	
IND. A+B: The sound will be output from both INDIVIDUAL A and B jacks.	
DecayTime1/DecayTime2/Rel. Time/ Attack Lev/Decay Lev	
0–100	These parameters specify how the volume changes over time, from when the bass tone is played until the sound decays to silence. This is referred to as the “envelope.”

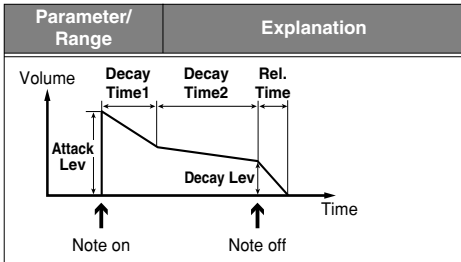

■ INS. FX (insert effect for the Bass part)

* This effect is monaural.



Parameter/Range	Explanation
Pan	
L50-CENTER-R50	Panning of the sound
Rev. Send	
0-100	Reverb depth
Out Assign	
see below	Output jack selection
MASTER: The sound will be output from the MASTER OUT jacks.	
IND. A: The sound will be output from the INDIVIDUAL A jack.	
IND. B: The sound will be output from the INDIVIDUAL B jack.	
IND. A+B: The sound will be output from both INDIVIDUAL A and B jacks.	

COMP (Compressor)

This effect makes the volume of the input signal more regular, producing longer sustain. It can also be used as a limiter to suppress only the peaks in order to prevent distortion. This effect will also help make the sound more consistent.

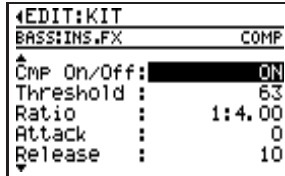

Parameter/Range	Explanation
Cmp On/Off	
OFF, ON	Comp On/Off
Threshold	
0-100	Volume at which the compressor begins to operate
Ratio	
1:1.00-1:16.0, 1:INF	Compression ratio
Attack	
0-100	Strength of the attack when you pluck a string
Release	
0-100	Time from when the signal falls below the specified Threshold level until the compressor is no longer applied
Level	
0-100	Volume of the signal after passing through the compressor

AMP SIM (Bass amp simulator)

This effect uses COSM technology to simulate the response of a bass amp.

EDIT:KIT
BASS:INS.FX AMP SIM
AMP On/Off: ON
Type :CONCERT 810
Gain : 50
Bass : 10
Middle : 0

Parameter/ Range	Explanation
Amp On/Off	
OFF, ON	AMP SIM on/off
Type	
see below	Bass amp type
CONCERT 810	Models an Ampeg SVT.
SESSION	Models an SWR SM-400.
BASS 360	Models an Acoustic 360.
T.E.	Models a Trace Elliot AH600SMX.
B-MAN	Models a Fender Bassman 100.
FLIP TOP	Models an Ampeg B-15.
BASS CLEAN	Clean sound.
BASS CRUNCH	Crunch sound with a natural distortion.
BASS HiGAIN	High gain sound.
FLAT	Flat response.
Gain	
0-100	Amount of amp distortion
Bass	
0-100	Low range tone
Middle	
0-100	Midrange tone
Treble	
0-100	High range tone
Presence	
0-100	Ultra-high range tone
Level	
0-100	Overall volume of the amp

Saving/Copying a kit

If you want to save a kit you created or edited, you must “Write” it as a user kit.

NOTE

If you re-select a kit, change pattern or song, or turn off the power before executing the Write procedure, your kit data will be lost.

Naming a kit

You can assign a name (kit name) of up to twelve characters to each user kit.

1. In the first kit edit screen, move the cursor “NAME” and press [ENTER].

The kit name edit screen appears.



2. Move the cursor to the location at which you want to input a character, and use the VALUE dial to choose a character.

Button operations	
[CURSOR] ▷ [CURSOR] ◁	Move the cursor.
[CURSOR] △	Switch from lowercase to uppercase characters.
[CURSOR] ▽	Switch from uppercase to lowercase characters.
[SHIFT]+ [CURSOR] ▷	Insert a space at the cursor location.
[SHIFT]+ [CURSOR] ◁	Delete the character at the cursor location, and shift subsequent characters to the left.

3. When you've finished specifying the name, press [EXIT].
4. Then continue to “Writing a kit.”

Writing a kit

1. In the first kit edit screen, move the cursor to “WRITE” and press [ENTER].

The kit write screen appears.



2. Use the VALUE dial to select the write-destination user kit number.
3. To write your edited kit into the selected destination, press [ENTER].

If you decide to cancel, press [EXIT].

The message “Now writing...” will appear, and the kit will be written.

When the kit have been written, the message will disappear.

* Do not turn off the power while the message is displayed. Your data may be damaged if you do so.

Copying a kit

1. In the first kit edit screen, move the cursor to “COPY” and press [ENTER].

The kit copy screen appears.

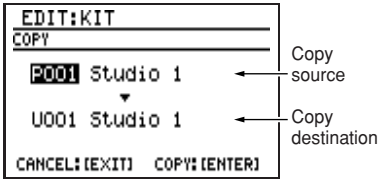

2. Move the cursor to the copy-source kit number, and use the VALUE dial to select the number of the kit that you want to copy.
3. Move the cursor to the copy-destination kit number, and use the VALUE dial to select the kit number to which you want to copy.
4. To execute the copy, press [ENTER]. If you decide to cancel, press [EXIT].

The message “Now writing...” will appear, and the copy will be carried out.

When the copy is completed, the message will disappear.

* Do not turn off the power while the message is displayed. Your data may be damaged if you do so.

Chapter 8

Convenient function/ System settings

FAVORITE function

You can register your favorite patterns/songs/effect patches to one of the FAVORITE buttons so that they can be recalled simply by pressing that button.

You can also register a combination, such as a pattern + effect patch or a song + effect patch. You can use the FAVORITE [1]-[4] buttons x 20 banks to register a total of eighty patterns, songs, or effect patches.

Recalling the registered content

* If you don't need to change the bank, simply press FAVORITE [1]-[4] to recall the contents that are registered for the button you pressed.

1. Press FAVORITE [BANK].

The current bank and the content registered to [1]-[4] within that bank are displayed.

FAVORITE BANK 01	
1	PTN P050:Three Chords 1
	GFX P02:BLUES CRUNCH
2	PTN P011:16Measures 1
	GFX P01:COOL LEAD
3	PTN P012:16Measures 2
	GFX P23:STACK CRUNCH
4	PTN P049:Blues Rock
	GFX P12:CLASSIC STK

2. Press a key pad 1-20 to select a bank 1-20.

* If you are using the currently selected bank, simply proceed to step 3.

* If you decide to cancel the FAVORITE operation at this point, press [EXIT].

3. Press one of the FAVORITE [1]-[4] buttons.

The button you pressed will light.

MEMO

- If, while a pattern is playing, you press a button to which a pattern has been registered, that pattern will be reserved; it will start playing when the current pattern has finished playing.
If, while a song is playing, you press a button to which a song has been registered, the analogous action will occur.
- If, while a pattern is playing, you press a button to which a song has been registered, playback will stop immediately; you will enter Song mode, and the DR-880 will pause, ready to play back the song.
If, while a song is playing, you press a button to which a pattern has been registered, the analogous action will occur.
- If, while a pattern/song is reserved, you press [■] to stop, the reservation will be cancelled.
- If an effect patch is registered to the button you pressed, that effect patch will be selected immediately.

Registering a favorite

1. While pattern/song playback is stopped, hold down [SHIFT] and press FAVORITE [BANK].

The Write Favorite screen appears.

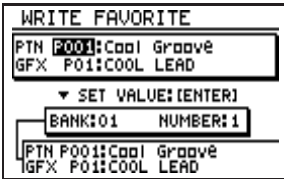

2. Move the cursor to the following items and use the VALUE dial to make settings.

PTN or SNG, number

Choose "PTN" to register a pattern, or choose "SNG" to register a song; then choose the number.

You can press [SONG/PATTERN] to switch between PTN and SNG.

GFX number

Select the effect patch number.

* If you don't need to register either a pattern/song or an effect patch, turn the VALUE dial toward the left to specify "---" as the number.

3. Press a key pad 1–20 to select the bank in which you want to register your favorite selection.
4. Press one of the FAVORITE [1]–[4] buttons to select the number in which you want to register your favorite selection.
5. If you are satisfied with your settings, press [ENTER] to confirm them.
6. Repeat steps 2–5 to register other favorites.

7. To put in place your registrations, press [EXIT].

The message "Now writing..." will appear, and your registrations will be saved.

When your registrations has been saved, the message will disappear.

Saving all current settings

Here's how you can save (write) all the following currently selected settings.

Settings	Write destination
Pattern or song	User pattern/song
Kit	User kit
TSC	TSC user patch
Guitar effects	Guitar effects user patch

If you've been editing these settings in parallel, it is convenient to use this method to write all settings in a single operation, instead of having to move to the Write screen for each group of settings.

1. Hold down [SHIFT] and press [WRITE] ([REC]).

The Write All setting screen appears.

For settings that have been edited, the number and name are displayed. "----" is shown for settings that have not been edited.



2. Move the cursor to the write destination for each item of data, and use the VALUE dial to select a number.

If you want to write your settings as user data, select "U**."

If you don't want to write a certain item, choose "----".

* If a preset is currently selected, the write destination will initially be a preset number.

If you attempt to carry out the Write procedure in this state, the message "Select user ***." will appear, and the data will not be written.

You must change the write destination to a user memory number or "----".

3. To write the data, press [ENTER].

If you decide to cancel, press [EXIT].

The message "Now writing..." will appear, and the currently selected settings will be written.

When the currently selected settings have been written, the message will disappear.

* Do not turn off the power while the message is displayed. Your data may be damaged if you do so.

System settings

Adjusting the output signal (Output Setting)

Here you can make final settings before the signal is sent from MASTER OUT.

1. Press [OUTPUT SETTING].

The Output Setting screen appears.

EDIT
OUTPUT SETTING:MASTER
Output Sel: LINE/PHONES
D. Out Lev : 100%
Low EQ : 0dB
High EQ : 0dB
Ambience : 100%

2. Use [CURSOR] </> to select the desired screen.

3. Move the cursor to the parameter you want to edit, and use the VALUE dial to specify the value.

■ MASTER

EDIT
OUTPUT SETTING:MASTER
Output Sel: LINE/PHONES
D. Out Lev : 100%
Low EQ : 0dB
High EQ : 0dB
Ambience : 100%

Parameter/Range	Explanation
Output Sel	
GUITAR AMP, LINE/PHONES	Specify the device connected to the MASTER OUT jacks
GUITAR AMP: Choose this if a guitar amp is connected	
LINE/PHONES: Choose this if an audio system or recorder is connected, or if you're listening through headphones connected to the PHONES jack	
D. Out Lev	
0-200%	Adjust the level of the digital audio signal sent from the DIGITAL OUT jack
Low EQ	
-20+20 dB	Low range boost/cut amount

Parameter/Range	Explanation
High EQ	
-20+20 dB	High range boost/cut amount
Ambience	
0-200%	Ambience volume

■ GUITAR

EDIT
OUTPUT SETTING:GUITAR
Out Assign: MASTER

Parameter/Range	Explanation
Out Assign	
MASTER, IND. A+B	Specify the jack(s) from which the sound from the GUITAR/BASS INPUT jack will be output
IND. A, IND. B	
MASTER: Output from MASTER OUT	
IND. A+B: Output from INDIVIDUAL A/B	
IND. A: Output from INDIVIDUAL A	
IND. B: Output from INDIVIDUAL B	

* If you select IND. A+B, IND. A, or IND. B, the following parameter is displayed.

Parameter/Range	Explanation
Output Sel	
GUITAR AMP, LINE/PHONES	Specify the device connected to the INDIVIDUAL A/B jacks
GUITAR AMP: Choose this if a guitar amp is connected	
LINE/PHONES: Choose this if an audio system or recorder is connected, or if you're listening through headphones connected to the PHONES jack	

4. When you've made the setting, press [EXIT].

The message "Now writing..." will appear, and the currently setting will be saved.

When the currently setting have been saved, the message will disappear.

* Do not turn off the power while the message is displayed. Your data may be damaged if you do so.

Adjusting the sensitivity of the key pads (Pad Sens)

1. From the pattern or song play screen, press [EDIT].

The edit menu screen appears.

2. Move the cursor to the “PAD” icon and press [ENTER].

The Pad Setting screen appears.

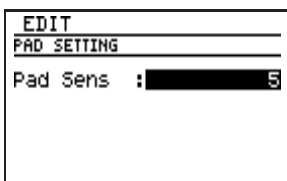

3. Use the VALUE dial to adjust the value.

Range: 0–10

Smaller values will decrease the sensitivity; you'll have to strike a pad strongly to produce a strong accent, but it will be easier to create subtle variations in dynamics. Larger values will increase the sensitivity; you'll be able to produce strong accents without having to strike a pad strongly, but it will be more difficult to create subtle variations in dynamics.

4. When you've made the setting, press [EXIT].

The message “Now writing...” will appear, and the currently setting will be saved. When the currently setting have been saved, the message will disappear.

* Do not turn off the power while the message is displayed. Your data may be damaged if you do so.

Tuning the bass part

Here's how to set the reference pitch of the bass part.

* The master tune setting is shared with the tuner reference pitch (p. 91).

* This will not affect the drum part.

1. From the pattern or song play screen, press [EDIT].

The edit menu screen appears.

2. Move the cursor to the “MASTER TUNE” icon and press [ENTER].

The Master Tune edit screen appears.

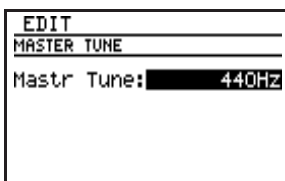

3. Use the VALUE dial to adjust the setting.

Range: 435 Hz–445 Hz

4. When you've made the setting, press [EXIT].

The message “Now writing...” will appear, and the currently setting will be saved. When the currently setting have been saved, the message will disappear.

* Do not turn off the power while the message is displayed. Your data may be damaged if you do so.

Using foot switches

You can connect up to foot switches (such as the FS-6, FS-5U: sold separately) to the rear panel CTL 1, 2 jack and CTL 3, 4/EXP PEDAL jack, and use them to control the function you assign, such as playback start/stop.

When Connecting the FS-6

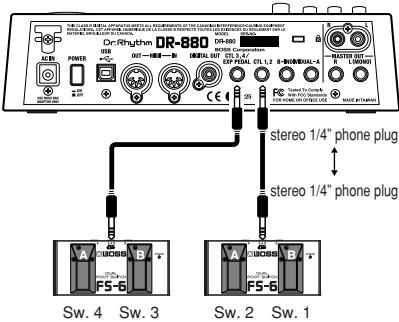

- Use a stereo 1/4" phone plug ↔ stereo 1/4" phone plug cable to make connections.
- Set the MODE switch and POLARITY switch as shown in the figure.

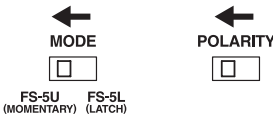

When Connecting the FS-5U

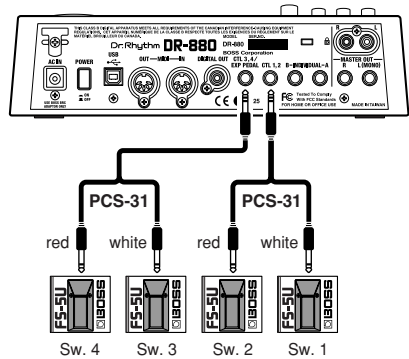

- In order to connect two foot switches to a jack, you will need a special cable (PCS-31; sold separately).
- Set the POLARITY switch as shown in the figure.

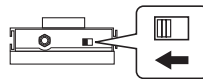

When connecting a single FS-5U to each jack

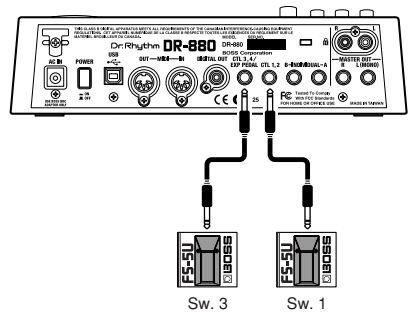

- If you connect only one foot switch to each jack, the settings for Sw. 1 and Sw. 3 will be used.

1. From the pattern or song play screen, press [EDIT].

The edit menu screen appears.

2. Move the cursor to the “FOOT SWITCH” icon, and press [ENTER].

The Foot Switch setting screen appears.

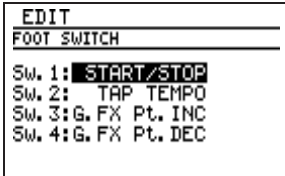

3. Move the cursor to Sw.1–4, and use the VALUE dial to choose the function that you want to assign to each foot switch.

Value	Explanation
START	The same function as pressing [▶].
STOP	The same function as pressing [■].
RESET	The same function as pressing [◀].
START/STOP	Pattern/song playback will alternately start or stop each time you press the foot switch. Playback will start from the point at which it was stopped.
RST+STA/STP	Pattern/song playback will alternately start or stop each time you press the foot switch. Playback will start from the beginning of the pattern or song.
TAP TEMPO	You can input Tap Tempo by pressing the foot switch at the desired interval.
LOOP	The same function as pressing [LOOP].
PTN/SNG INC	Switch to the pattern or song of the next number.
PTN/SNG DEC	Switch to the pattern or song of the preceding number.
* If you press the switch while a pattern or song is playing, the next selected pattern or song will start playing after the current pattern or song has finished playing.	
G.FX ON/OFF	Switch the guitar effect on/off.
G.FX Pt. INC	Switch to the effect patch of the next number.

Value	Explanation
G.FX Pt. DEC	Switch to the effect patch of the preceding number.
FAVORITE 1–4	The same function as pressing FAVORITE [1]–[4].
FAVOR. INC	Switch to the FAVORITE registration of the next number.
FAVOR. DEC	Switch to the FAVORITE registration of the preceding number.
FAV.BNK.INC	Switch to the FAVORITE bank of the next number.
FAV.BNK.INC	Switch to the FAVORITE bank of the preceding number.
BANK1 PAD01– BANK3 PAD20	Pressing the foot switch will have the same result as striking the key pad of the corresponding pad bank/number. Move the cursor to “V” and specify the velocity (1–127) at which the note is to be played.

4. When you’ve made the setting, press [EXIT].

The message “Now writing...” will appear, and the currently settings will be saved. When the currently settings have been saved, the message will disappear.

* Do not turn off the power while the message is displayed. Your data may be damaged if you do so.

Adding a count-in

If you add a count-in as described below, pressing [▶] will play a count-in before pattern/song playback begins.

1. From the pattern or song play screen, press [EDIT].

The edit menu screen appears.

2. Move the cursor to the “PLAY OPTION” icon, and press [ENTER].

The Play Option screen appears.

EDIT	
PLAY OPTION	COUNT IN
Measures :	OFF
Inst :	STICK
Level :	100
Kit SelMod:	LINK

3. Move the cursor to the desired item, and use the VALUE dial to set the value.

Parameter/Range	Explanation
Measures	
OFF, 1–2MEAS	Number of count-in measures
If you choose OFF, a count-in will not be added.	
Inst	
STICK, Hi-HAT, VOICE	Sound used for the count-in
Level	
0–100	Volume of the count-in

4. When you’ve made the setting, press [EXIT].

The message “Now writing...” will appear, and the currently setting will be saved.

When the currently setting have been saved, the message will disappear.

* Do not turn off the power while the message is displayed. Your data may be damaged if you do so.

Using the same kit/TSC patch for playing all patterns and songs

Normally, when you play back a pattern or song, the kit and TSC patch specified by each pattern or song will be used.

However, if desired, you can disable this so that the currently selected kit and/or TSC patch will be used when playing any pattern or song.

1. From the pattern or song play screen, press [EDIT].

The edit menu screen appears.

2. Move the cursor to the “PLAY OPTION” icon, and press [ENTER].

The Play Option screen appears.

EDIT	
PLAY OPTION	COUNT IN
Measures :	OFF
Inst :	STICK
Level :	100
Kit SelMod:	LINK

3. Move the cursor to each of the items listed below, and use the VALUE dial to set the value.

EDIT	
PLAY OPTION	OTHERS
▲ Level :	100
Kit SelMod:	LINK
TSC SelMod:	LINK
PowerOnPtn:	P001

Parameter/Range	Explanation
Kit SelMod	
LINK, MANUAL	Kit select mode
LINK:	
The kit specified individually for each pattern and song will be used for playback.	
MANUAL:	
The currently selected kit will be used for playing any pattern or song.	

Parameter/ Range	Explanation
TSC SelMod	
LINK, MANUAL	TSC select mode
LINK: The TSC patch specified individually for each pattern and song will be used for playback.	
MANUAL: The currently selected TSC patch will be used for playing any pattern or song.	

4. When you've made the setting, press [EXIT].

The message "Now writing..." will appear, and the currently setting will be saved.

When the currently setting have been saved, the message will disappear.

* Do not turn off the power while the message is displayed. Your data may be damaged if you do so.

Specifying the pattern at power-on

Here's how you can specify the pattern that will be selected immediately after the DR-880 is powered on.

1. From the pattern or song play screen, press [EDIT].

The edit menu screen appears.

2. Move the cursor to the "PLAY OPTION" icon, and press [ENTER].

The Play Option screen appears.

EDIT	
PLAY OPTION	COUNT IN
Measures :	OFF
Inst :	STICK
Level :	100
Kit SelMod:	LINK

3. Move the cursor to the "PowerOnPtn," and use the VALUE dial to select the patch number.

Range: P001-U500

EDIT	
PLAY OPTION	OTHERS
↑Level :	100
Kit SelMod:	LINK
TSC SelMod:	LINK
PowerOnPtn:	P001

4. When you've made the setting, press [EXIT].

The message "Now writing..." will appear, and the currently setting will be saved.

When the currently setting have been saved, the message will disappear.

* Do not turn off the power while the message is displayed. Your data may be damaged if you do so.

Chapter 9

Using MIDI

About MIDI

MIDI (Musical Instrument Digital Interface) is a universal standard that allows electronic musical instruments and computers to exchange performance data and other information. By using MIDI cables to connect devices that have MIDI connectors, you enable them to send and receive data.

MIDI connectors

The DR-880 has MIDI IN and MIDI OUT connectors.

OUT — MIDI — IN

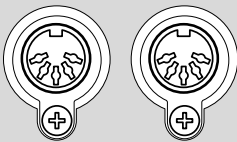

MIDI IN

This connector receives data from another MIDI device. Connect it to the MIDI OUT connector of your external MIDI device.

MIDI OUT

This connector transmits data from the DR-880. Connect it to the MIDI IN connector of your external MIDI device.

MIDI implementation chart

In order for a specific type of MIDI message to be transferred successfully, both MIDI devices must support that particular message.

So that you can quickly and conveniently tell whether two MIDI devices will be able to “talk to” each other, a MIDI implementation chart is always included in the owner’s manual of every MIDI device. By comparing the MIDI implementation charts of the two devices, you can quickly see which messages can be transmitted and received between the two devices.

* A separate publication titled “MIDI Implementation” is also available. It provides complete details concerning the way MIDI has been implemented on this unit. If you should require this publication (such as when you intend to carry out byte-level programming), please contact the nearest Roland Service Center or authorized Roland distributor.

NOTE

If you want to use the MIDI connectors for MIDI communication with external MIDI equipment, set the USB Mode to “STORAGE” (p. 134).

TIP

You can use the USB connector for MIDI communication with your computer. (See p. 143)

Playing the DR-880 from an external MIDI device/ Playing an external MIDI device from the DR-880

You can play the DR-880 by sending it performance data from an external MIDI device, or play an external MIDI device by operating the DR-880.

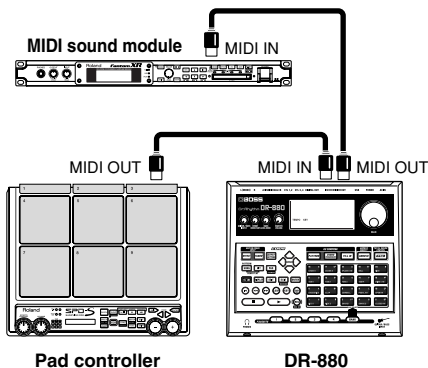

Setting the MIDI channel

In order for performance data to be transferred between an external MIDI device and the DR-880, both devices must be set to the same MIDI channel.

You can make separate MIDI channel settings for the drum part and the bass part.

Setting the Volume receive switch

This switch allows you to specify whether Volume messages are to be received or not. If this is ON, Volume messages received on the MIDI channels specified for the Drum and Bass part will control the volume of the respective part.

1. **With playback stopped, press [EDIT].**
The edit menu screen appears.
2. **Move the cursor to the “MIDI” icon, and press [ENTER].**
The MIDI menu screen appears.
3. **Move the cursor to the “SETTING” icon, and press [ENTER].**
The MIDI setting screen appears.

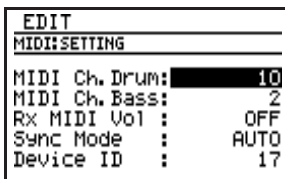

4. **Move the cursor to “MIDI Ch. Drum” or “MIDI Ch. Bass,” and use the VALUE dial to specify the MIDI channel for each.**

Parameter/ Range	Explanation
MIDI Ch. Drum	
1-16, OFF	Specify the MIDI channel for the drum part. If this is OFF, MIDI messages will not be transmitted/received.
MIDI Ch. Bass	
1-16, OFF	Specify the MIDI channel for the bass part. If this is OFF, MIDI messages will not be transmitted/received.

- * You must set the Drum part and the Bass part to different MIDI channels.
- * Program change messages are received on the MIDI channel of the drum part.
- * Note messages produced when you strike the key pads (p. 127) are transmitted on the MIDI channel of the drum part or the bass part.

5. **Move the cursor to “Rx MIDI Vol” and use the VALUE dial to set ON/OFF.**

Parameter/ Range	Explanation
Rx MIDI Vol	
OFF, ON	ON: Volume messages will be received. OFF: Volume messages will not be received.

6. **When you’ve made the setting, press [EXIT].**
The message “Now writing...” will appear, and the currently settings will be saved. When the currently settings have been saved, the message will disappear.
- * Do not turn off the power while the message is displayed. Your data may be damaged if you do so.

Performance data used by the DR-880

MIDI message	Drum Ch	Bass Ch
Note on/off	Yes	Yes
Bank select (CC#00)	Yes	
Program change	Yes	
Volume (CC#7)	Yes	Yes
RPN (Bend range)		Yes
Pitch bend		Yes

Note messages

These messages are used to play the drum part and bass part. On a keyboard instrument, these messages indicate that a note has been played. Note messages carry the following information.

- Note number:** The number for a key pad to which an instrument or bass tone is assigned
- Note-on:** Transmitted when you strike a key pad
- Note-off:** (Bass part only) Transmitted when you take your finger off a key pad
- Velocity:** Indicates the force with which you strike a key pad

The DR-880's key pads correspond to MIDI note numbers as follows.

Pad Bank: DRUM 1

49	57	55	53	51
50	48	45	41	52
37	39	56	44	46
36	35	38	40	42

Pad Bank: DRUM 2

89	90	93	84	59
69	94	70	82	92
54	91	95	96	97
60	61	62	63	64

Pad Bank: DRUM 3

73	74	58	80	81
71	72	75	67	68
76	77	85	66	65
86	87	78	79	83

When you strike a DR-880 key pad, a note-on message containing the note number assigned to that key pad is transmitted.

When a note message is received from an external MIDI device, the instrument/bass tone of the key pad to which the corresponding note number is assigned will play.

- * If the note number of the received note message does not correspond to any key pad, that note message will be ignored.

Bank Select/Program Change messages

Program number	Bank number	
	0	1
1	P001	U001
2	P002	U002
3	P003	U003
:	:	:
100	P100	U100
101	ignore	ignore
:	:	:
128	ignore	ignore

These messages will switch kits.

Transmit the bank number and then the program number. The bank number alone will not switch the kit. If you don't need to change the bank number, you can simply transmit the program number alone.

- * For details on the messages that can be received and transmitted by a connected external device, refer to the manual for that device.

Pitch Bend/Bend Range

Pitch bend messages are messages that change the pitch of the bass. You can use RPN messages to specify the range within which the pitch is permitted to change (bend range).

For example, if you want to set the bend range to 12, transmit the following messages.

```
RPN MSB (CC#101)    00
RPN LSB (CC#100)    00
DATA ENTRY MSB (CC#6) 12 (the desired value)
```

Synchronizing the DR-880 with a digital recorder or MIDI sequencer

You can make the DR-880 play in synchronization with a digital recorder, MIDI sequencer, or rhythm machine.

Master and slave

When two or more devices are to be operated in synchronization, one device must be the master, while all the other devices become slaves.

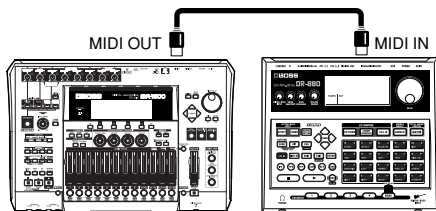

Master

Slave (DR-880)

When start/stop operations are performed on the master device, it will transmit MIDI Start/Stop messages. Each slave device will start or stop in accordance with the MIDI messages it receives.

The master device also transmits Timing Clock messages according to the playback tempo. Each slave device will play in synchronization with the Timing Clock messages it receives. Other messages are also sent from the master device to the slave devices, such as the song number (Song Select) and the location within the song (Song Position Pointer).

Messages used by the DR-880 for synchronization

The DR-880 uses the following MIDI messages for playback synchronization.

- Start
- Timing Clock
- Continue
- Song Select
- Stop
- Song Position Pointer

* For details on the MIDI messages that can be handled by external devices you've connected, refer to the owner's manuals of your equipment.

Sync Mode setting

The Sync Mode setting specifies whether the DR-880 will operate as a slave or master.

1. **With playback stopped, press [EDIT].**
The edit menu screen appears.
2. **Move the cursor to the "MIDI" icon, and press [ENTER].**
The MIDI menu screen appears.
3. **Move the cursor to the "SETTING" icon and press [ENTER].**
The MIDI setting screen appears.

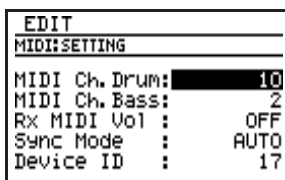

4. **Move the cursor to "Sync Mode," and use the VALUE dial to specify the sync mode.**

Parameter/ Range	Explanation
Sync Mode	
INTERNAL: The DR-880 will be the master. Playback will start/stop when you operate the DR-880, and the playback tempo will be as specified on the DR-880.	
MIDI: The DR-880 will be the slave. It will start/stop according to messages received from an external MIDI device, and its playback will synchronize to Timing Clock messages received from an external MIDI device.	
REMOTE: Only the start/stop operations of the DR-880 will be controlled by messages received from an external MIDI device.	
AUTO: Master/slave settings will be switched automatically. Normally, the DR-880 will be the master, but it will automatically become a slave if a Start message is received from an external MIDI device while the DR-880 is stopped.	

5. When you've made the setting, press [EXIT].

The message "Now writing..." will appear, and the currently setting will be saved. When the currently setting have been saved, the message will disappear.

* *Do not turn off the power while the message is displayed. Your data may be damaged if you do so.*

Tempo when operating as a slave

When the DR-880 is operating as a slave, you can't control the tempo from the DR-880 itself.

Recording an external MIDI device's performance on the DR-880

Your performance on an external MIDI keyboard or MIDI pads can be recorded on the DR-880 in real time, or performance data from your MIDI sequencer or rhythm can be recorded on the DR-880.

- If you want to record a performance from an external device, set the Sync Mode setting to "AUTO" (p. 128).
- In order for the performance data to be received correctly, the transmitting and receiving devices must be set to the same channel. For details on how to set the MIDI channel, refer to p. 126.

Recording a performance from your MIDI keyboard or MIDI pads

When recording a performance from your MIDI keyboard or MIDI pads as a DR-880 pattern, you'll use pattern realtime recording.

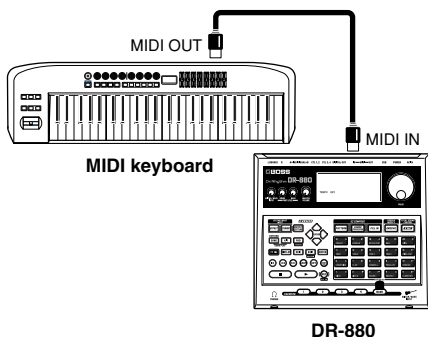

1. First make various settings as described in "<2> Making basic settings for the pattern" (p. 53).
2. Proceed as described in "<3-1> Using realtime recording" (p. 54), and play your external MIDI keyboard or MIDI pads in step 6.
3. When you're finished recording, press [■].

Recording a performance from your sequencer or rhythm machine

When recording performance data from a connected sequencer or rhythm machine, you'll use the connected device to control the start of recording on the DR-880.

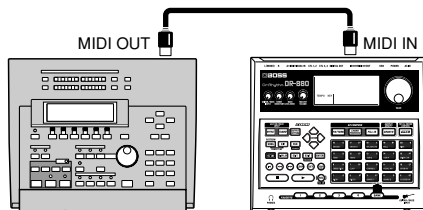

MIDI sequencer etc.

DR-880

1. Put the DR-880 in record-ready mode.
2. Play back the connected sequencer or rhythm machine.
At the same time, the DR-880 will start recording.
3. When you're finished recording, press [■].

Transmitting a DR-880 bulk dump/Receiving a bulk dump back to the DR-880

“Bulk Dump” refers to the process of sending DR-880 data to a MIDI sequencer or to another DR-880 unit.

“Bulk Load” refers to the process of retrieving bulk data that’s been saved on a MIDI sequencer and loading it back into the DR-880, or receiving the bulk data being sent by another DR-880 unit.

Setting the Device ID

Bulk Dump and Bulk Load operations use a type of message called an “exclusive message” to transfer data that is specific to a particular device (such as patterns and kits). In order for an exclusive message to be sent and received successfully, the Device ID Number of both devices must match.

1. **With playback stopped, press [EDIT].**
The edit menu screen appears.
2. **Move the cursor to the “MIDI” icon, and press [ENTER].**
The MIDI menu screen appears.
3. **Move the cursor to the “SETTING” icon, and press [ENTER].**
The MIDI setting screen appears.

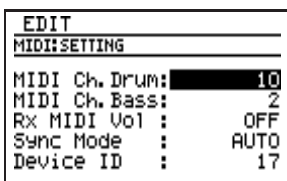

4. **Move the cursor to “Device ID,” and use the VALUE dial to specify the device ID number.**
Range:17–32
5. **When you’ve made the setting, press [EXIT].**
The message “Now writing...” will appear, and the currently setting will be saved. When the currently setting have been saved, the message will disappear.

* Do not turn off the power while the message is displayed.
Your data may be damaged if you do so.

Transmitting DR-880 data (Bulk Dump)

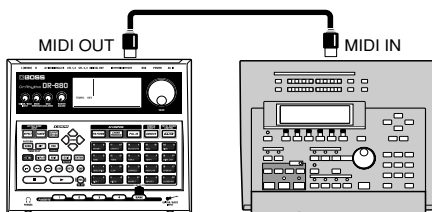

Transmit device (DR-880)

Receive device (MIDI sequencer etc.)

1. **With playback stopped, press [EDIT].**
The edit menu screen appears.
2. **Move the cursor to the “MIDI” icon, and press [ENTER].**
The MIDI menu screen appears.
3. **Move the cursor to the “B. DUMP” icon and press [ENTER].**
The bulk dump setting screen appears.

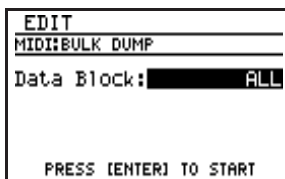

4. **Use the VALUE dial to select the type of data you want to transmit.**

Parameter/Range	Explanation
Data Block	
All:	All data of the DR-880
PTN/SONG:	All user patterns and songs
KIT:	All user kits

Parameter/Range	Explanation
TSC: All TSC user patches	
GUITAR FX: All guitar effects user patches	
SYSTEM: System settings (output setting, LCD contrast, key pad sensitivity, master tune, foot switch, MIDI, count-in)	

5. Press [ENTER].

The message "Now dumping..." will appear, and the bulk dump will begin.

If you want to abort the bulk dump transmission, press [EXIT].

When the message "Stopped" appears, press [ENTER].

* If you execute Bulk Dump with "ALL" selected, it is possible that the memory of the receiving device may fill up during reception, and that no further data will be received. If this occurs, choose a setting other than ALL and execute Bulk Dump again.

■ Returning the transmitted data to the DR-880 (Bulk Load)

Transmit the data from the connected MIDI device.

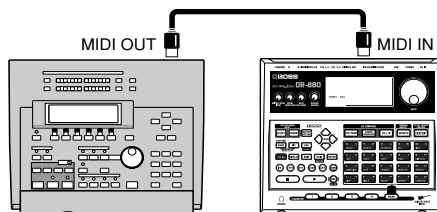

Transmit device
(MIDI sequencer etc.)

Receive device
(DR-880)

1. With playback stopped, press [EDIT].
The edit menu screen appears.
2. Move the cursor to the "MIDI" icon, and press [ENTER].
The MIDI menu screen appears.
3. Move the cursor to the "B. LOAD" icon and press [ENTER].
The bulk load standby screen appears.

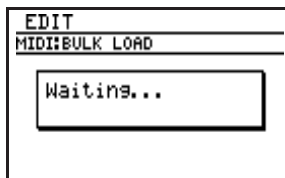

4. Transmit the data from the connected MIDI device.
While the DR-880 is receiving data, the message "Now receiving..." is displayed.
5. Press [EXIT] to complete the bulk load.

Chapter 10

Using USB

If you use a USB cable to connect between the DR-880's USB connector and your computer, you'll be able to do the following things.

SMF import

You can create patterns by importing SMF (Standard MIDI File) data from your computer.

Data backup and recovery

You can save (back up) DR-880 user data on your computer.

You can also load (recover) saved data from your computer into the DR-880.

MIDI communication

You can send and receive MIDI messages between your computer and the DR-880. In order to do this, you will need to install the USB MIDI driver on your computer. Please read "InstallManualE.pdf" (PDF file) included on the CD-ROM, and proceed as directed.

■ Connecting a computer

Use the USB cable to connect the DR-880 to your computer.

Purchase USB cables at computer stores or other retailers.

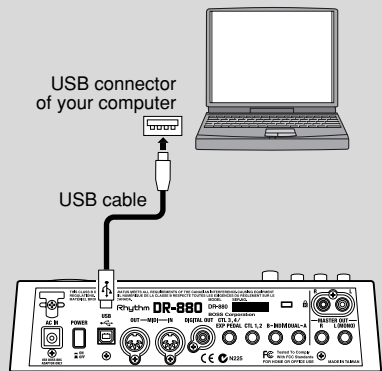

Before you use USB

Supported operating systems

	SMF import	Data backup/recover	MIDI communication
Windows XP/2000/Me or later	Yes	Yes	Yes
Windows 98/98SE	No	No	Yes
Mac OS 9	Yes	Yes	Yes
Mac OS X	Yes	Yes	Yes

* If you're importing SMF data or backing up/recovering data, the standard driver provided by the operating system will be installed automatically when you connect the DR-880 to your computer via USB.

Notes on Using USB

Do not perform the operations listed below while the DR-880 and your computer are in a state where communication can occur, or while data is being transferred. These operations may result in your computer not responding to the data.

Data on memory cards may also be corrupted. Do not:

- Disconnect the USB cable
- Put the computer in suspended (standby) mode or hibernation, restart, or quit
- Turn off the DR-880's power

Switching the USB function

Before you connect the DR-880 to your computer, you must specify whether the DR-880 will use USB for "SMF import/data backup/recovery," or "MIDI communication."

- 1. With playback stopped, press [EDIT].**
The edit menu screen appears.
- 2. Move the cursor to the "USB" icon and press [ENTER].**
The USB menu screen appears.

- 3. Move the cursor to the "MODE" icon and press [ENTER].**
The USB mode setting screen appears.

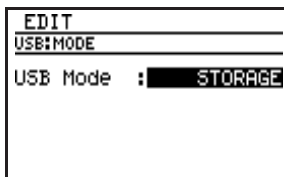

- 4. Use the VALUE dial to select the desired USB function.**

STORAGE:

Choose this if you want to import SMF data, or back up/recover data.

MIDI:

Choose this if you want to transmit/receive MIDI messages between the DR-880 and your computer.

- 5. When you've made the setting, press [EXIT].**

The message "Now writing..." will appear, and the USB function will be saved.

When the USB function have been saved, the message will disappear.

- 6. Switch off the DR-880, then turn the power back on again.**

NOTE

If the USB Mode is set to "MIDI," MIDI communication via the DR-880's own MIDI connectors will not be possible.

If you want to use the MIDI connectors for MIDI communication with external MIDI equipment, set the USB Mode to "STORAGE."

* MIDI communication via USB cannot be used simultaneously with MIDI communication via the MIDI connectors.

Importing SMF data to create a pattern

You can create a pattern by importing SMF (Standard MIDI File) data from your computer.

NOTE

The following SMF data cannot be imported.

- SMF Format 2
- SMF data with a time signature other than 2/4–4/8 or 4/8–16/8
- SMF data that is larger than the free amount of the DR-880's user memory

Data	Comment
Song name	Single-byte alphanumeric characters and symbols only
Tempo	Only at the beginning of the song, and limited to a range of 20–260
Beat	Only at the beginning of the song, and limited to a range of 2/4–4/8 and 4/8–16/8
Bank select (CC#00)	Only at the beginning of the song, and Drum Ch only
Program change	Drum Ch, Bass Ch
Note on/off	Bass Ch only
RPN (Bend range)	Bass Ch only
Pitch bend	Bass Ch only

Windows users

1. Use a USB cable to connect the DR-880 to your computer.
2. With playback stopped, press [EDIT].
The edit menu screen appears.
3. Move the cursor to the “USB” icon and press [ENTER].
The USB menu screen appears.
4. Move the cursor to the “IMPORT” icon and press [ENTER].
The SMF import screen appears.

* If USB Mode is set to “MIDI,” the message “Check USB Mode!” is displayed, and the SMF Import screen will not appear. Press [ENTER], and change the USB Mode to “STORAGE,” and then power it up again (p. 134).

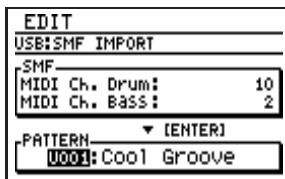

5. Move the cursor to “MIDI Ch. Drum” and use the VALUE dial to specify the MIDI channel of the drum part you want to import from SMF.
Range: 1–16, OFF
6. Move the cursor to “MIDI Ch. Bass” and use the VALUE dial to specify the MIDI channel of the bass part you want to import from SMF.
Range: 1–16, OFF
7. Move the cursor to “PATTERN” and use the VALUE dial to specify the pattern number into which the data is to be imported.
Range: 001–500

* If you choose OFF, the drum part will not be imported.

* If you choose OFF, the bass part will not be imported.

* The user pattern selected as the import destination will be overwritten in the import process.

8. Press [ENTER].

When connection with the PC has been established, the message will displayed "1.Copy one SMF" and "2.CloseConnection." A "BOSS_DR-880" icon (or a "Removable disk (*)" icon) will appear on your computer.

(Ex.)

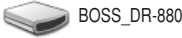

9. Drag and drop the SMF file you want to import onto the "DR-880" icon (or the "Removable disk (*)" icon).

* Only one file can be imported in one operation. Do not drag and drop two or more files.

When the copy is completed, the idling screen will reappear.

10.Close the USB connection.

Windows XP users

Right-click the "DR-880" icon (or the "Removable disk (*)" icon) in My Computer, and execute "Remove."

If you are unable to execute the "Remove" operation in this way, proceed as follows.

- 1) Click the  icon in the task tray, and click the message that indicates "Safely remove drive (*)."



- 2) In the "Safely Remove Hardware" dialog box, click [OK].

Windows 2000/Me users

- 1) Right-click the "DR-880" icon (or the "Removable disk (*)" icon) in My Computer, and execute "Remove."
- 2) Click the  icon in the task tray, and click the message that indicates "Safely remove drive (*)."



- 3) In the "Safely Remove Hardware" dialog box, click [OK].

11.Press [EXIT].

* If you press [EXIT] without copying SMF data to the DR-880, the message "No file!" is displayed. In this case, press [ENTER] to return to the SMF Import screen.

The message "Now writing..." will appear, and the SMF will be imported.

When the SMF have been imported, the message will disappear.

At this point, you can safely disconnect the USB cable from the DR-880 and the computer.

NOTE

If you press [EXIT] without performing step 10, the message "Import cancel?" is displayed. In this case, press [EXIT] and then perform step 10. If you press [ENTER], the Import operation will be cancelled, and you will return to the SMF Import screen.

Macintosh users

1. Use a USB cable to connect the DR-880 to your computer.

2. With playback stopped, press [EDIT].
The edit menu screen appears.

3. Move the cursor to the “USB” icon and press [ENTER].
The USB menu screen appears.

4. Move the cursor to the “IMPORT” icon and press [ENTER].
The SMF import screen appears.

* If USB Mode is set to “MIDI,” the message “Check USB Mode!” is displayed, and the SMF Import screen will not appear. Press [ENTER], and change the USB Mode to “STORAGE,” and then power it up again (p. 134).

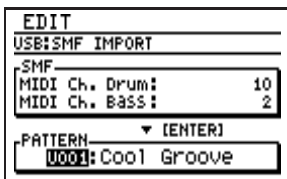

5. Move the cursor to “MIDI Ch. Drum” and use the VALUE dial to specify the MIDI channel of the drum part you want to import from SMF.
Range: 1–16, OFF

* If you choose OFF, the drum part will not be imported.

6. Move the cursor to “MIDI Ch. Bass” and use the VALUE dial to specify the MIDI channel of the bass part you want to import from SMF.
Range: 1–16, OFF

* If you choose OFF, the bass part will not be imported.

7. Move the cursor to “Pattern Num.” and use the VALUE dial to specify the pattern number into which the data is to be imported.
Range: 001–500

* The user pattern selected as the import destination will be overwritten in the import process.

8. Press [ENTER].

When connection with the PC has been established, the message will be displayed “1.Copy one SMF” and “2.CloseConnection.” A “BOSS_DR-880” icon will appear on your computer.

(Ex.)

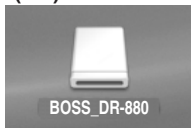

9. Drag and drop the SMF file you want to import onto the “DR-880” icon.

* Only one file can be imported in one operation. Do not drag and drop two or more files.

10. Close the USB connection.

On your computer, drag the “DR-880” icon into the trash.

11. Press [EXIT].

* If you press [EXIT] without copying SMF data to the DR-880, the message “No file!” is displayed. In this case, press [ENTER] to return to the SMF Import screen.

The message “Now writing...” will appear, and the SMF will be imported.

When the SMF has been imported, the message will disappear.

At this point, you can safely disconnect the USB cable from the DR-880 and the computer.

NOTE

If you press [EXIT] without performing step 10, the message “Import cancel?” is displayed.

In this case, press [EXIT] and then perform step 10. If you press [ENTER], the Import operation will be cancelled, and you will return to the SMF Import screen.

Backing up the DR-880's data

Windows users

1. Use a USB cable to connect the DR-880 to your computer.

2. With playback stopped, press [EDIT].
The edit menu screen appears.

3. Move the cursor to the "USB" icon and press [ENTER].
The USB menu screen appears.

4. Move the cursor to the "BACKUP" icon and press [ENTER].
The USB backup screen appears.

* If USB Mode is set to "MIDI," the message "Check USB Mode!" is displayed, and the SMF Backup screen will not appear. Press [ENTER], and change the USB Mode to "STORAGE," and then power it up again (p. 134).

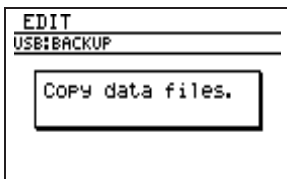

* If there is any edited data that has not been saved, the "Cancel edit?" message will appear.
If you press [ENTER], your edits will be discarded, and the unedited data will be backed up.
If you press [EXIT], the backup process will be aborted, and you will return to the USB menu screen.

When connection with the computer has been established, the message will be displayed "Copy data files."

A "BOSS_DR-880" icon (or a "Removable disk (*)" icon) will appear on the computer.

(Ex.)

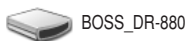

BOSS_DR-880



Removable Disk (*)

5. Double-click the "BOSS_DR-880" (or "Removable disk (*):") icon.

The files from the DR-880 will be displayed on the computer.

File name	Contents
SYSTEM.DR8	System settings
UGFX.DR8	Guitar effects user patches
UKIT.DR8	User kits
USEQ.DR8	User patterns and user songs
UTSC.DR8	TSC user patches

6. Copy the files to be backed up into a backup folder on your computer.

It is good practice to create a new folder for the storage of backup data.

7. Close the USB connection.

Windows XP users

Right-click the "BOSS_DR-880" icon (or the "Removable disk (*)" icon) in My Computer, and execute "Remove."

If you are unable to execute the "Remove" operation in this way, proceed as follows.

1) Click the  icon in the task tray, and click the message that indicates "Safely remove drive (*):".



Task bar ↑ ↑ Task tray

2) In the "Safely Remove Hardware" dialog box, click [OK].

Windows 2000/Me users

- 1) Right-click the "BOSS_DR-880" icon (or the "Removable disk (*:*)" icon) in My Computer, and execute "Remove."
- 2) Click the  icon in the task tray, and click the message that indicates "Safely remove drive (*:)*".

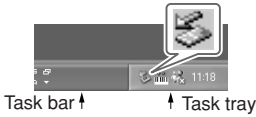

- 3) In the "Safely Remove Hardware" dialog box, click [OK].

8. Press [EXIT].

At this point, you can safely disconnect the USB cable from the DR-880 and the computer.

NOTE

If you press [EXIT] without performing step 7, the message "Disconnect, OK?" is displayed.

In this case, press [EXIT] and then perform step 7.

- * If you press [ENTER], the connection between the DR-880 and the computer will be forcibly terminated. In this case, it is possible that the backup will be incomplete, making successful recovery impossible.

Macintosh users

1. Use a USB cable to connect the DR-880 to your computer.
2. With playback stopped, press [EDIT].
The edit menu screen appears.
3. Move the cursor to the "USB" icon and press [ENTER].
The USB menu screen appears.
4. Move the cursor to the "BACKUP" icon and press [ENTER].
The USB backup screen appears.

- * If USB Mode is set to "MIDI," the message "Check USB Mode!" is displayed, and the SMF Backup screen will not appear. Press [ENTER], and change the USB Mode to "STORAGE," and then power it up again (p. 134).

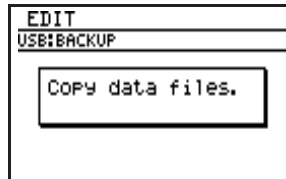

- * If there is any edited data that has not been saved, the "Cancel edit?" message will appear.
If you press [ENTER], your edits will be discarded, and the unedited data will be backed up.
If you press [EXIT], the backup process will be aborted, and you will return to the USB menu screen.

When connection with the computer has been established, the message will be displayed "Copy data files."

A "BOSS_DR-880" icon will appear on the computer.

(Ex.)

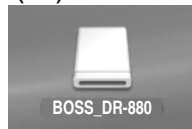

5. Double-click the “BOSS_DR-880” icon.

The files from the DR-880 will be displayed on the computer.

File name	Contents
SYSTEM.DR8	System settings
UGFX.DR8	Guitar effects user patches
UKIT.DR8	User kits
USEQ.DR8	User patterns and user songs
UTSC.DR8	TSC user patches

6. Copy the files to be backed up into a backup folder on your computer.

It is good practice to create a new folder for the storage of backup data.

7. Close the USB connection.

On your computer, drag the “BOSS_DR-880” icon into the trash.

8. Press [EXIT].

At this point, you can safely disconnect the USB cable from the DR-880 and the computer.

NOTE

If you press [EXIT] without performing step 7, the message “Disconnect, OK?” is displayed. In this case, press [EXIT] and then perform step 7.

* *If you press [ENTER], the connection between the DR-880 and the computer will be forcibly terminated. In this case, it is possible that the backup will be incomplete, making successful recovery impossible.*

Reading backup data back into the DR-880 from the computer (Recover)

Windows users

1. Use a USB cable to connect the DR-880 to your computer.
2. With playback stopped, press [EDIT].
The edit menu screen appears.
3. Move the cursor to the “USB” icon and press [ENTER].
The USB menu screen appears.
4. Move the cursor to the “RECOVER” icon and press [ENTER].
The USB recover screen appears.

* If USB Mode is set to “MIDI,” the message “Check USB Mode!” is displayed, and the SMF Recover screen will not appear. Press [ENTER], and change the USB Mode to “STORAGE,” and then power it up again (p. 134).

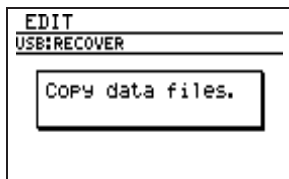

When connection with the computer has been established, the message will be displayed “Copy data files.”

A “BOSS_DR-880” icon (or a “Removable disk (*)” icon) will appear on the computer.

(Ex.)



BOSS_DR-880



Removable Disk (*)

5. Open the folder on the computer where you have stored the backup data.
6. Select all of the files you want to back into the DR-880.
7. Copy them to the “BOSS_DR-880” icon (or “Removable disk (*)” icon) on the computer.

8. Close the USB connection.

Windows XP users

Right-click the “BOSS_DR-880” icon (or the “Removable disk (*)” icon) in My Computer, and execute “Remove.”

If you are unable to execute the “Remove” operation in this way, proceed as follows.

- 1) Click the  icon in the task tray, and click the message that indicates “Safely remove drive (*):”.



Task bar ↑ ↑ Task tray

- 2) In the “Safely Remove Hardware” dialog box, click [OK].

Windows 2000/Me users

- 1) Right-click the “BOSS_DR-880” icon (or the “Removable disk (*)” icon) in My Computer, and execute “Remove.”
- 2) Click the  icon in the task tray, and click the message that indicates “Safely remove drive (*):”.



Task bar ↑ ↑ Task tray

- 3) In the “Safely Remove Hardware” dialog box, click [OK].

9. Press [EXIT].

The message “Now writing...” will appear, and the backup data will be recovered.

When the backup data have been recovered, the message will disappear.

At this point, you can safely disconnect the USB cable from the DR-880 and the computer.

NOTE

If you press [EXIT] without performing step 8, the message “Disconnect, OK?” is displayed. In this case, press [EXIT] and then perform step 8.

- * If you press [ENTER], the connection between the DR-880 and the computer will be forcibly terminated. In this case, it is possible that the recovery will be incomplete, causing the operation of the DR-880 to later become unstable.

Macintosh users

1. Use a USB cable to connect the DR-880 to your computer.

2. With playback stopped, press [EDIT].
The edit menu screen appears.

3. Move the cursor to the “USB” icon and press [ENTER].
The USB menu screen appears.

4. Move the cursor to the “RECOVER” icon and press [ENTER].
The USB recover screen appears.

- * If USB Mode is set to “MIDI,” the message “Check USB Mode!” is displayed, and the SMF Recover screen will not appear. Press [ENTER], and change the USB Mode to “STORAGE,” and then power it up again (p. 134).

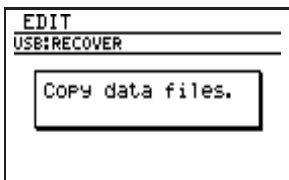

When connection with the computer has been established, the message will be displayed “Copy data files.”

A “BOSS_DR-880” icon will appear on the computer.

(Ex.)

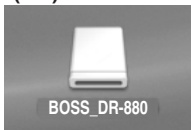

5. Open the folder on the computer where you have stored the backup data.

6. Select all of the files you want to back into the DR-880.

7. Copy them to the “BOSS_DR-880” icon on the computer.

8. Close the USB connection.
On your computer, drag the “BOSS_DR-880” icon into the trash.

9. Press [EXIT].
The message “Now writing...” will appear, and the backup data will be recovered. When the backup data have been recovered, the message will disappear. At this point, you can safely disconnect the USB cable from the DR-880 and the computer.

NOTE

If you press [EXIT] without performing step 8, the message “Disconnect, OK?” is displayed. In this case, press [EXIT] and then perform step 8.

- * If you press [ENTER], the connection between the DR-880 and the computer will be forcibly terminated. In this case, it is possible that the recovery will be incomplete, causing the operation of the DR-880 to later become unstable.

Exchanging MIDI messages with your computer (MIDI Communication)

Driver installation and settings

In order to allow MIDI communication between the DR-880 and your computer, you must first install the USB MIDI driver.

* *The USB MIDI driver is included on the CD-ROM "DR-880 Driver."*

What is the USB MIDI driver?

The USB MIDI driver is software that passes MIDI messages between the DR-880 and an application running on your computer (e.g., recording software or sequencing software) when your computer and the DR-880 are connected via a USB cable.

The USB MIDI driver sends MIDI messages from your application to the DR-880, and sends MIDI messages from the DR-880 to your application.

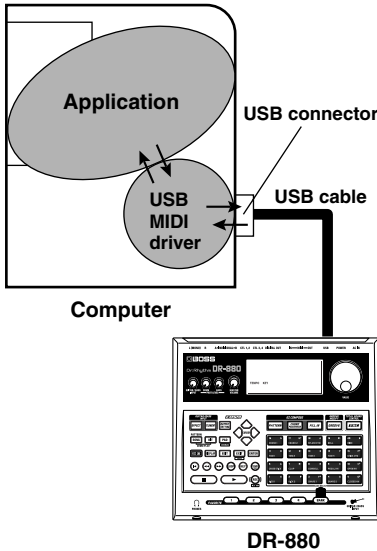

NOTE

Installing the USB MIDI driver

The program and procedure for installing the USB MIDI driver will depend on the computer system you are using. Please read "InstallManualE.pdf" (PDF file) included on the CD-ROM, and proceed as directed.

* *You will need Adobe Reader in order to read "InstallManualE.pdf."*

Switching the USB function

If you want to use the USB connector for MIDI communication with your computer, set the USB Mode to "MIDI" (p. 134).

MEMO

Appendices

Restoring the factory settings (Factory Reset)

You can restore the DR-880 to the condition it was in when it left the factory. This operation is called "Factory Reset."

NOTE

When you execute Factory Reset, the user data will return to its factory-set condition. If the DR-880 contains important data you want to keep, use Bulk Dump (p. 131) to save the data on an external MIDI device, or use USB backup (p. 138) to save the data on the computer before you execute Factory Reset.

1. With playback stopped, press [EDIT].

The edit menu screen appears.

2. Move the cursor to the "FACTORY RESET" icon and press [ENTER].

The display will ask "Factory reset?"

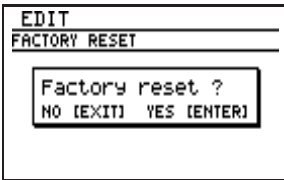

3. If you're sure you want to execute Factory Reset, press [ENTER]. If you decide to cancel without executing, press [EXIT].

The message "Now writing..." will appear, and factory reset will be executed.

When factory reset have been completed, the message will disappear.

* Do not turn off the power while the message is displayed. Your data may be damaged if you do so.

Troubleshooting

Problems with the sound

No sound

- Could the MASTER VOLUME be set to the minimum? (p. 13)
- Could the PART LEVEL DRUM knob be set to the minimum? (p. 13)
- Could the PART LEVEL BASS knob be set to the minimum? (p. 13)
- Could you have selected a pattern or song that contains no performance data?
- Could the sound be set for output from the INDIVIDUAL jacks? (p. 107–p. 111, p. 119)

The volume of the guitar / bass connected to the GUITAR/BASS INPUT is too low

- Could the GUITAR/BASS INPUT knob be set to the minimum position? (p. 13)
- Could you be using a connection cable that contains a resistor?
Use a connection cable that does not contain a resistor.

Sound is interrupted

- Could you be attempting to play more than 32 notes simultaneously? (The DR-880 is able to play a maximum of 32 notes simultaneously.)
- Could mute group settings have been made? (p. 107)

Pressing [▶] does not start playback

- Could the Sync Mode be set to “MIDI”? (p. 128)
- Could you have selected a pattern or song that contains no performance data?

Loop playback doesn't occur when you press [LOOP]

- Could you be in Pattern mode?
- Could the Loop End setting be greater than the number of measures in the song? (p. 77, p. 82)

Problems with MIDI

An external MIDI device won't play the DR-880 / The DR-880 won't play an external MIDI device

- Could the MIDI channel settings be incorrect? (p. 126)
- Could the note number settings be incorrect? (p. 127)

Problems with USB

Can't import SMF data or back up/recover data

- Is the USB cable connected correctly?
- Does the operating system of your computer support the DR-880? (p. 134)
- Did you set the USB Mode to “STORAGE,” switch the DR-880 off, then power it up again? (p. 134)

Can't communicate with your computer via MIDI

- Is the USB cable connected correctly?
- Does the operating system of your computer support the DR-880? (p. 134)
- Is the driver installed correctly? (p. 143)
- Did you set the USB Mode to “MIDI,” switch the DR-880 off, then power it up again? (p. 134)

Message List

Buffer full!

Cause 1: Too many MIDI messages were received all at once, and the DR-880 was unable to process all of them.

Action 1: Reduce the volume of the MIDI messages being sent by the transmitting device.

Cause 2: You attempted to play back an excessive amount of data, and the DR-880 was unable to process all of it.

Action 2: Reduce the amount of data being played back, or slow down the playback tempo.

Checksum Error !

Cause: MIDI Exclusive messages could not be received correctly during a Bulk Load operation.

Action: Try the operation again.

File error !

Cause: During an SMF Import, you attempted to use a file of a type other than those specified, or one that is invalid.

Action: Use the specified type of file.

Memory full !

Cause: Memory is full.

Action: Save the pattern/song you are creating, and then delete unneeded patterns or songs.

MIDI off line !

Cause: A MIDI Active Sensing error has occurred. An abnormality has been detected in the device or cable connected to MIDI IN.

Action: Check the device or cable connected to MIDI IN.

Not supported !

Cause: You attempted to import SMF data that the DR-880 does not support.

Action: Check that the SMF is in a format that can be imported by the DR-880. (p. 135)

Now working...

Cause: Data is being processed.

Action: Please wait until the message disappears.

Now writing...

Cause: Data is being saved to memory.

Action: Never turn off the power while this message is displayed.

* *If you turn off the power while this message is displayed, it is possible that previously saved data (in addition to the data now being written) will also be lost.*

Too Busy !

Cause: The system attempted to concurrently process abnormally large amounts of data, but was unable to succeed.

Action: Make sure that the unit is not being forced to handle an overly large amount of data (in patterns, or received MIDI messages) all at once, and try to reduce the amount of data.

Use pattern mode

Cause: You attempted to use EZ Compose or Groove Modify in Song mode.

Action: Switch to Pattern mode before using EZ Compose or Groove Modify.

User data is damaged. Factory Reset

Cause: The data in the DR-880's internal memory is damaged. (This message will appear when you turn on the power.)

Action: Press [ENTER] to reset the DR-880 to the factory-set condition.

System Error !

Cause: An unknown error has occurred in the system.

Action: Immediately stop using the unit, and consult your dealer or nearest Roland Service Center.

Parameter List

Pattern

Parameter	Range	Reset Value
Pattern name	14 characters	
INFO		
Beat	2/4–8/4, 4/8–16/8	4/4
Measures1–999	4	
Tempo	20–260	120
Arrange	OFF, ON	OFF
Key	-, C–B, Cm–Bm	-
Rec.Key	C–B, Cm–Bm	C
Key Shift	-12→+12	0
Kit Number	P001–P100, U001–U100	P001
TSC Switch	OFF, ON	ON
TSC Number	P01–P20, U01–U20	P01

Song

Parameter	Range	Reset Value
Song name	14 characters	
INFO		
Init.tempo	OFF, 20–260	120
Key Shift	-12→+12	0
Loop Start	1–n	1
Loop End	1–n	1
Kit Select	SONG, PATTERN	SONG
Kit Number	P001–P100, U001–U100	P001
TSC Select	SONG, PATTERN	SONG
TSC Switch	OFF, ON	ON
TSC Number	P01–P20, U01–U20	P01

System

Parameter	Range	Reset Value
Output Select/Master		
Output Sel	GUITAR AMP, LINE/PHONES	LINE/ PHONES
D. Out Lev	0–200%	100%
Low EQ	-20→+20 dB	0 dB
High EQ	-20→+20 dB	0 dB
Ambience	0–200%	100%
Output Select/Guitar		
Out Assign	MASTER, IND. A+B, IND. A, IND. B	MASTER
Output Sel	GUITAR AMP, LINE/PHONES	LINE/ PHONES

Parameter List

Parameter	Range	Reset Value
LCD		
Contrast	1–16	9
PAD		
Pad Sens	0–10	5
MASTER TUNE		
Mastr Tune	435–445 Hz	440 Hz
FOOT SWITCH		
Sw. 1–Sw. 4	START, STOP, RESET, START/STOP, RST+STA/STP, TAP TEMPO, LOOP, PTN/SNG INC, PTN/SNG DEC, G.FX ON/OFF, G.FX Pt. INC, G.FX Pt. DEC, FAVORITE 1–4, FAVOR. INC, FAVOR. DEC, FAV.BNK.INC, FAV.BNK.DEC, BANK1 PAD01–BANK3-PAD20 (V=1–127)	1: START/STOP 2: TAP TEMPO 3: G.FX Pt. INC 4: G.FX Pt. DEC
PLAY OPTION/COUNT IN		
Measures	OFF, 1MEAS, 2MEAS	OFF
Inst	STICK, Hi-HAT, VOICE	STICK
Level	0–100	80
PLAY OPTION/OTHERS		
Kit SelMod	LINK, MANUAL	LINK
TSC SelMod	LINK, MANUAL	LINK
PowerOnPtn	P001–P500, U001–U500	P001
MIDI/SETTING		
MIDI Ch. Drum	1–16, OFF	10
MIDI Ch. Bass	1–16, OFF	2
Rx MIDI Vol	OFF, ON	OFF
Sync Mode	INTERNAL, MIDI, REMOTE, AUTO	AUTO
Device ID	17–32	17
USB/MODE		
USB Mode	STORAGE, MIDI	STORAGE

Preset Data List

Instrument

No.	Name
Kick	
001	Dry Kick 1
002	Dry Kick 2
003	Dry Kick 3
004	Dry Kick 4
005	Dry Kick 5
006	Dry Kick 6
007	Rock Kick1
008	Rock Kick2
009	RockDryKck
010	DryHybdKck
011	ReverbKick
012	StdioKick1
013	StdioKick2
014	Warm Kick
015	Hush Kick
016	Hush Kick2
017	Wide Kick1
018	Wide Kick2
019	Reg.Kick 1
020	Reg.Kick 2
021	RckCmpKck1
022	RckCmpKck2
023	Jazz Kick
024	Jz DryKick
025	Maple Kick
026	HybridKick
027	Verb Kick
028	Round Kick
029	Power Kick
030	Sharp Kick
031	Old Kick
032	Elec Kick
033	MdverbKick
034	TightKick1
035	TightKick2
036	HipHopKck1
037	HipHopKck2
038	R&B Kick 1
039	R&B Kick 2
040	R&B Kick 3
041	R&B Kick 4
042	R&B Kick 5

No.	Name
043	TechnoKck1
044	TechnoKck2
045	TechnoKck3
046	TechnoKck4
047	70s Kick 1
048	70s Kick 2
049	TR909Kick1
050	TR909Kick2
051	TR909Kick3
052	TR909Kick4
053	TR909Kick5
054	TR909Kick6
055	909 DryKck
056	TR808 Kick
057	TR707 Kick
058	TR606 Kick
059	TR606DstBD
060	Plstic BD1
061	Plstic BD2
062	DR110 Kick
063	SH32 Kick
064	AnalogKick
Snare	
065	Dry 1 Rim
066	Dry 1 Snr
067	Dry 2 Rim
068	Dry 2 Snr
069	Dry 3 Rim
070	Dry 3 Snr
071	Dry 4 Rim
072	Dry 4 Snr
073	Dry 5 Rim
074	Dry 5 Snr
075	Dry 6 Rim
076	Dry 6 Snr
077	Dry 7 Snr
078	Rock Rim
079	Rock Snare
080	FatsoSnare
081	DryHybdSnr
082	RockRimSnr
083	Heavy Rim
084	Heavy Snr

No.	Name
085	Stdio1 Rim
086	Stdio1 Snr
087	Stdio2 Rim
088	Stdio2 Snr
089	TitanSnr 1
090	TitanSnr 2
091	TitanSnr 3
092	TitanSnr 4
093	Bright Snr
094	Iron Snr 1
095	Iron Snr 2
096	Wood Snr 1
097	Wood Snr 2
098	Wood Snr 3
099	Wood Snr 4
100	Wet Snare1
101	Wet Snare2
102	AmbientSN1
103	AmbientSN2
104	Reg.Snare1
105	Reg.Snare2
106	HibridSnr1
107	HibridSnr2
108	Rash Snare
109	SharpSnare
110	Old FillSN
111	PiccoloSnr
112	MapleSnare
113	NaturlSnr1
114	NaturlSnr2
115	Ballad Snr
116	BechSnare1
117	Bech 2 Rim
118	Bech 2 Snr
119	Jazz 1 Rim
120	Jazz 1 Snr
121	Jazz 2 Rim
122	Jazz 2 Snr
123	Brush Slap
124	Brush Swsh
125	Swish&Turn
126	BrushSnare
127	R&B Snre 1

No.	Name
128	R&B Snre 2
129	R&B Snre 3
130	R&B Snre 4
131	R&B Snre 5
132	R&B Snre 6
133	R&B Snre 7
134	R&B Snre 8
135	R&B Snre 9
136	R&B Snre10
137	R&B Snre11
138	R&B Snre12
139	JnglTinySD
140	TinySnare1
141	TinySnare2
142	DJ Snare
143	Phat Snare
144	Lo-HardSnr
145	TR909 Snr1
146	TR909 Snr2
147	TR909 Snr3
148	TR909 Snr4
149	909 DrySnr
150	TR808 Snr1
151	TR808 Snr2
152	TR808 Snr3
153	808 DrySnr
154	707 DrySnr
155	TR606 Snr1
156	TR606 Snr2
157	TR909 Rim
158	TR808 Rim
159	DR110Snare
160	CR78 Snare
161	Flange Snr
162	Dirty Snr1
163	Dirty Snr2
164	Analog Snr
165	Elec Snare
Cross Stick	
166	Dry Stick
167	Funk Stick
168	Rock Stick
169	Wood Stick

No.	Name
170	Wild Stick
171	Stdio1Stck
172	Stdio2Stck
173	Reg.Stick
174	Soft Stick
175	Side Stick
176	R&B Stick1
177	R&B Stick2
Tom	
178	Dry 1 Tom1
179	Dry 1 Tom2
180	Dry 1 Tom3
181	Dry 1 Tom4
182	Dry 2 Tom1
183	Dry 2 Tom2
184	Dry 2 Tom3
185	Dry 2 Tom4
186	Dry 3 Tom1
187	Dry 3 Tom2
188	Dry 3 Tom3
189	Dry 3 Tom4
190	Dry 4 Tom1
191	Dry 4 Tom2
192	Dry 4 Tom3
193	Dry 4 Tom4
194	Roto Tom 1
195	Roto Tom 2
196	Roto Tom 3
197	Roto Tom 4
198	Stdio1Tom1
199	Stdio1Tom2
200	Stdio1Tom3
201	Stdio1Tom4
202	Reg.Tom 1
203	Reg.Tom 2
204	Reg.Tom 3
205	Reg.Tom 4
206	Room Tom 1
207	Room Tom 2
208	Room Tom 3
209	Room Tom 4
210	Jazz Tom 1
211	Jazz Tom 2
212	Jazz Tom 3
213	Jazz Tom 4
214	Maple Tom1
215	Maple Tom2

No.	Name
216	Maple Tom3
217	Maple Tom4
218	Verb Tom 1
219	Verb Tom 2
220	Verb Tom 3
221	Verb Tom 4
222	BrushTom 1
223	BrushTom 2
224	BrushTom 3
225	BrushTom 4
226	Stdio2Tom1
227	Stdio2Tom2
228	Stdio2Tom3
229	Stdio2Tom4
230	BrBeatTom1
231	BrBeatTom2
232	BrBeatTom3
233	BrBeatTom4
234	R&B Tom 1
235	R&B Tom 2
236	R&B Tom 3
237	R&B Tom 4
238	Deep Tom
239	909 DstTom
240	707 DryTom
241	TR909 Tom
242	808 DryTom
243	TR808 Tom
Hi-Hat	
244	Light CHH1
245	Light CHH2
246	Light CHH3
247	Light HfHH
248	Light PdHH
249	Light OpHH
250	Dry 1CIHH1
251	Dry 1CIHH2
252	Dry 1 OpHH
253	Dry 2CIHH1
254	Dry 2CIHH2
255	Dry 2 OpHH
256	Dry 2 PdHH
257	Reg.CIHH 1
258	Reg.CIHH 2
259	Reg.HfHH
260	Reg.PdHH
261	Reg.OpHH

No.	Name
262	Stdio CIHH
263	Stdio PHHH
264	Stdio PdHH
265	Stdio OpHH
266	Rock CIHH1
267	Rock CIHH2
268	Rock CIHH3
269	Rock PdHH
270	Rock OpHH
271	Jazz CIHH
272	Jazz PdHH
273	Jazz OpHH
274	Brush CIHH
275	Brush OpHH
276	TR808 CIHH
277	TR808 OpHH
278	TR909 CHH1
279	TR909 CHH2
280	TR909 OpHH
281	TR909 PdHH
282	909 DryCHH
283	909 DryOHH
284	707 DryCHH
285	707 DryOHH
286	TR606 CIHH
287	TR606 OpHH
288	HipHop CHH
289	HipHop OHH
290	BrBeatCHH1
291	BrBeatCHH2
292	BrBeatOpHH
293	R&B CIHH 1
294	R&B OpHH 1
295	R&B CIHH 2
296	R&B OpHH 2
Cymbal	
297	Stdio Cym1
298	Stdio Cym2
299	Stdio Cym3
300	Stdio Cym4
301	Reg.CrCym1
302	Reg.CrCym2
303	Dry CrCym
304	RockCrCym1
305	RockCrCym2
306	Jazz CrCym
307	BrushCrCym

No.	Name
308	StdioRide1
309	StdioRide2
310	StdioRide3
311	StdioRide4
312	StdRdBell1
313	StdRdBell2
314	Rock Ride1
315	Rock Ride2
316	RockRdBell
317	Reg.RdBell
318	Jazz RdCym
319	Rock China
320	RockSplash
321	SwishCymbl
322	TR909Crash
323	808 DryCym
324	707 DryCym
325	TR606 Cym
326	TR909 Ride
327	707DryRide
328	DR110 Cym
329	MG Nz Cym
330	US Nz Cym
Percussion	
331	Conga L2Op
332	Bongo H
333	Bongo L
334	Conga H Mt
335	Conga H Op
336	Conga L Mt
337	Conga L Op
338	Conga HSlp
339	Timbale H
340	Timbale L
341	Agogo H
342	Agogo L
343	Cowbell
344	Cabasa Up
345	Cabasa Dwn
346	Maracas
347	Whistle 1S
348	Whistle 1L
349	Whistle 2S
350	Whistle 2L
351	Guiro
352	Guiro Long
353	Claves

No.	Name
354	WoodBlockH
355	WoodBlockL
356	Mute Cuica
357	Open Cuica
358	TriangleMt
359	TriangleOp
360	Tambourin1
361	Tambourin2
362	Shaker 1
363	Shaker 2
364	Sleighbell
365	Wind Chime
366	Castanet
367	Mute Surdo
368	Open Surdo
369	OpPandeiro
370	MtPandeiro
371	Asian Gong
372	Vibraslap
373	Snap
374	Club Snap
375	TR707 Tamb
376	CR78 Guiro
377	CR78 Beat

No.	Name
378	CR78 Tamb
379	CR78Cowbel
380	808Cowbell
381	808 Claves
382	808Conga
383	808Maracas
384	Tabla 1
385	Tabla 2
386	Tabla 3
387	Udo
388	Udu PotHi
389	Udu PotSlp
390	Cajon 1
391	Cajon 2
392	Cajon 3
Clap	
393	Hand Clap
394	Club Clap
395	Short Clap
396	Real Clap
397	R8 Clap
398	Amb Clap
399	Hip Clap
400	Funk Clap

No.	Name
401	Group Clap
402	TR808 Clap
403	Disc Clap
404	Dist Clap
405	TR909Clap1
406	TR909Clap2
407	TR707 Clap
408	Cheap Clap
Fx	
409	Back Hit
410	Tekno Hit
411	Philly Hit
412	Dist Hit
413	Thin Beef
414	Smear Hit
415	Scratch1ps
416	Scratch2ps
417	Scratch2pl
418	Scratch1pl
419	MG Zap 1
420	MG Zap 2
421	MG Zap 3
422	Beam HiQ
423	Vox Kick 1

No.	Name
424	Vox Kick 2
425	Vox Snare1
426	Vox Snare2
427	Vox Hihat1
428	Vox Hihat2
429	Vox Hihat3
430	Vox Cymbal
431	One
432	Two
433	Three
434	Four
435	Aah!
436	Hou!
437	Pa!
438	Chiki!
439	Bass Glis1
440	Bass Glis2

Bass Tone

No.	Name	Voice
01	FingerBs 1	1
02	Finger/Nz1	1
03	FingerBs 2	1
04	Finger/Nz2	1
05	FingerBs 3	1
06	Finger/Nz3	1
07	RockFinger	1
08	PickedBs 1	1
09	Picked/Nz1	1
10	PickedBs 2	1
11	Picked/Nz2	1
12	PickedBs 3	1
13	Picked/Nz3	1
14	RockPicked	1
15	Stick Bass	1

No.	Name	Voice
16	PickMute 1	1
17	PickMute 2	1
18	Slap Bass	1
19	Slap/Nz	1
20	Slap Pop	1
21	WetFretles	1
22	FatFretles	1
23	Upright Bs	2
24	Upright/Nz	2
25	AcousticBs	1
26	Fing/Slap1	1
27	Fing/Slap2	1
28	Fing/Harm1	1
29	Fing/Harm2	1
30	4 PoleBass	1

No.	Name	Voice
31	SH101 Bass	1
32	Tick Bass	2
33	Juno Bass	2
34	Solid Bass	1
35	Drum'n'Bass	1
36	House Bass	1
37	GarageBass	1
38	FM Bass	1
39	MGSaw Bass	1
40	TB303 Bass	1

Kit

No.	Name
P001	Studio 1
P002	Studio 2
P003	Studio 3
P004	Studio 4
P005	Studio 5
P006	Studio 6
P007	Studio 7
P008	Comp Studio
P009	Total Comp
P010	Room 1
P011	Room 2
P012	Room 3
P013	Room 4
P014	Room 5
P015	Room 6
P016	Room 7
P017	Natural 1
P018	Natural 2
P019	Natural 3
P020	Rock 1
P021	Rock 2
P022	Rock 3
P023	Rock 4
P024	Rock 5
P025	Rock 6
P026	Rock 7
P027	Rock 8
P028	Rock 9
P029	Rock 10
P030	Rock 11
P031	Light Rock
P032	Long HH
P033	Funk Rock 1
P034	Funk Rock 2
P035	Power 1
P036	Power 2
P037	Power 3
P038	Power 4
P039	Maple Hard
P040	Ambient
P041	Gated
P042	Dry
P043	Pop 1
P044	Pop 2
P045	Pop 3

No.	Name
P046	Pop 4
P047	Pop 5
P048	Pop 6
P049	Pop 7
P050	Pop 8
P051	Half R&B
P052	Fusion 1
P053	Fusion 2
P054	Fusion 3
P055	Fusion 4
P056	Fusion 5
P057	Fusion 6
P058	Funk 1
P059	Funk 2
P060	Funk 3
P061	Soul 1
P062	Soul 2
P063	Reggae
P064	Ballad
P065	Rockabilly
P066	Country 1
P067	Country 2
P068	Slow Light
P069	Unplugged 1
P070	Unplugged 2
P071	Unplugged 3
P072	Vintage 1
P073	Vintage 2
P074	Vintage 3
P075	Jazz 1
P076	Jazz 2
P077	Jazz 3
P078	Brush 1
P079	Brush 2
P080	R&B 1
P081	R&B 2
P082	R&B 3
P083	R&B 4
P084	R&B 5
P085	HipHop 1
P086	HipHop 2
P087	HipHop 3
P088	HipHop 4
P089	HipHop 5
P090	House 1

No.	Name
P091	House 2
P092	Techno 1
P093	Techno 2
P094	Techno 3
P095	BreakBeats 1
P096	BreakBeats 2
P097	BreakBeats 3
P098	Electro
P099	Voice Drum
P100	India

TSC Patch

No.	Name
P01	AMBIENCE 1
P02	AMBIENCE 2
P03	AMBIENCE 3
P04	SMALL ROOM
P05	MEDIUM ROOM
P06	RICH ROOM
P07	SMALL HALL
P08	WARM HALL
P09	RICH HALL
P10	LIGHT PLATE

No.	Name
P11	COOL PLATE
P12	RICH PLATE
P13	BRIGHT ROOM
P14	TIGHT ROOM
P15	HEAVY ROOM
P16	TIGHT HALL
P17	POWER PLATE
P18	Lo-Fi PLATE
P19	CATHEDRAL
P20	STADIUM

Effect Patch

No.	Name	Effect Type
P01	COOL LEAD	GTR MULTI
P02	CLEAN CHORUS	GTR MULTI
P03	R-FIER STACK	GTR MULTI
P04	CHORUS COMBO	GTR MULTI
P05	HEAVY METAL	GTR MULTI
P06	ECHO LEAD	GTR MULTI
P07	T-AMP LEAD	GTR MULTI
P08	1959 LEAD	GTR MULTI
P09	LEAD STACK	GTR MULTI
P10	CHORUS LEAD	GTR MULTI
P11	SMOOTH LEAD	GTR MULTI
P12	CLASSIC STK	GTR MULTI
P13	5150 STACK	GTR MULTI
P14	HiGAIN STACK	GTR MULTI
P15	POWER STACK	GTR MULTI
P16	T-AMP DRIVE	GTR MULTI
P17	COMBO DRIVE	GTR MULTI
P18	SMOOTH DRIVE	GTR MULTI
P19	FLANGE DRIVE	GTR MULTI
P20	CHORUS DRIVE	GTR MULTI
P21	COOL CRUNCH	GTR MULTI
P22	TWEED BLUES	GTR MULTI
P23	STACK CRUNCH	GTR MULTI
P24	VOXY DRIVE	GTR MULTI
P25	T.WAH CRUNCH	GTR MULTI

No.	Name	Effect Type
P26	TEMPO DELAY	GTR MULTI
P27	COMBO ECHO	GTR MULTI
P28	'60s ECHO	GTR MULTI
P29	MILD CRUNCH	GTR MULTI
P30	PHASE CRUNCH	GTR MULTI
P31	TIGHT CRUNCH	GTR MULTI
P32	BLUES CRUNCH	GTR MULTI
P33	T.WAH LEAD	GTR MULTI
P34	TREMOLO DRV	GTR MULTI
P35	JC-120 CLEAN	GTR MULTI
P36	WARM CLEAN	GTR MULTI
P37	MILD JAZZ	GTR MULTI
P38	BRIGHT CLEAN	GTR MULTI
P39	CLEAN LEAD	GTR MULTI
P40	CLEAN PAN	GTR MULTI
P41	E.Gt->Ac.Gt	GTR MULTI
P42	ACOUSTIC	ACO MULTI
P43	POWER AcGt	ACO MULTI
P44	AcGt CHORUS	ACO MULTI
P45	AcGt SOLO	ACO MULTI
P46	CLEAN BASS	BASS MULTI
P47	ROCK BASS	BASS MULTI
P48	POWER BASS	BASS MULTI
P49	BASS CHORUS	BASS MULTI
P50	DRIVE BASS	BASS MULTI

Pattern

No.	Name	Category
001	Cool Groove	Rock
002	Shuffle Funk	Shuffle Funk
003	Heavy Rock	Heavy Rock
004	Foxy Rock	Rock
005	Latin Pop	Latin Pop
006	Perc Bossa	Bossa Nova
007	Goin' On	Pop
008	Rock Fusion	Rock Fusion
009	FretlessFusion	Fusion
010	R&B Pop	R&B Pop
011	16Measures 1	Rock
012	16Measures 2	
013	Shaker Rock	
014	Bnz Rock 1	
015	Bnz Rock 2	
016	Bnz Rock 3	
017	Super Rock	
018	Dream Rock 1	
019	Dream Rock 2	
020	Deep Rock	
021	Slap Bass	
022	Guitar Rock 1	
023	Guitar Rock 2	
024	Guitar Rock 3	
025	Rock Toms	
026	Slow Rock	
027	Ex Dream Rock	
028	Air Rock	
029	Ballad Rock	
030	Dixie Rock	
031	American Rock	
032	Flame Rock	
033	Reggae Rock	
034	I'll Be Rock	
035	Bass & Drum	
036	Jelly Jam 1	
037	Jelly Jam 2	
038	Latin Rock 1	
039	Latin Rock 2	
040	Latin Rock 3	

No.	Name	Category
041	Cry Rock	Rock
042	Ride Rock	
043	Light Rock	
044	Start Rock	
045	Hot Rock	
046	Hardest Rock	
047	Double Rock	
048	After Rock	
049	Blues Rock	Blues Rock
050	Three Chords 1	Blues
051	Three Chords 2	
052	Wing Blues	Blues Rock
053	BluesShuffle 1	Blues Shuffle
054	BluesShuffle 2	
055	Slow Blues	Slow Blues
056	Rock Ballad	Rock Ballad
057	West Coast	West Coast
058	Rockabilly	Rockabilly
059	Ride Beat	16 Beat Rock
060	Strong Beat	
061	16Beat Rock 1	
062	16Beat Rock 2	
063	Fast 16Beat	Fast 16 Beat
064	Anthem Rock	Shuffle Rock
065	Moon Shuffle	
066	Foot Shuffle	
067	Ride Shuffle	
068	Rock Jam 1	
069	Rock Jam 2	
070	Town Shuffle	
071	City Shuffle	Surf Rock
072	Shuffle Rock	
073	Surf Rock 1	Rock
074	Surf Rock 2	
075	StraightRock 1	
076	StraightRock 2	
077	Miami	
078	Simple Rock 1	
079	Simple Rock 2	
080	Simple Rock 3	

No.	Name	Category	
081	AcousticRock 1	Rock	
082	AcousticRock 2		
083	Break Rock	Heavy Rock	
084	Machine Rock		
085	Heavy Step		
086	Crush Rock		
087	Massive Rock		
088	8th Heavy		
089	Metallic		
090	Dark Rock 1		Fast Rock
091	Dark Rock 2		
092	Dark Rock 3		
093	Fast Rock 1		
094	Fast Rock 2		
095	Tension Rock		
096	J-Rock		
097	Ridge Rock		
098	Hard Rock 1	Hard Rock	
099	Hard Rock 2		
100	Hard Rock 3		
101	Standard Hard		
102	Fast Hard		
103	Hard Shuffle 1		
104	Hard Shuffle 2	Heavy Metal	
105	Hard Shuffle 3		
106	Neo Classical		
107	Thrash Ready..		
108	Thrash Go!		
109	Shout Metal		
110	Twin Pedal 1	Alt Rock	
111	Twin Pedal 2		
112	Twin Pedal 3		
113	Punker		
114	Tri Heavy		
115	Alternatively		
116	Alt Heavy Rock		
117	Ultramarine		
118	Alt Light Ride		
119	Alt Light Hat		
120	Alt Rock 1		

No.	Name	Category
121	Alt Rock 2	Alt Rock
122	Alt Rock 3	
123	Human Beat Box	Pop
124	My Face Pop	
125	Pickup	
126	Way Pop	
127	6/8 Pop	
128	Cool Pop 1	
129	Cool Pop 2	
130	Groove Cut	
131	Light Pop 1	
132	Light Pop 2	
133	Light Pop 3	
134	All Night Pop	
135	Planet Fusion	
136	Pop 16Beat	
137	Pop 8Beat	
138	Pop Four	
139	Scaling Bass	
140	Slap Pop	
141	Slow Pop 1	
142	Slow Pop 2	
143	Night Pop	Pop Rock
144	Anybody Pop	
145	Don't Stop	
146	Fretless Pop	
147	Pop Rock	
148	Heavy Pop	
149	PopinRockLatin	
150	Medium Pop 1	Shuffle Pop
151	Medium Pop 2	
152	Swing Pop	
153	Cool Shuffle	
154	High Groove	
155	Groovy Pop	
156	Happy Shuffle	
157	Pop Shuffle	
158	Med Shuffle	
159	Shuffle Jam	
160	Soul Pop 1	
161	Soul Pop 2	
162	Shuffle Pop 1	
163	Shuffle Pop 2	

No.	Name	Category
164	R&B Shuffle	R&B Pop
165	Cool R&B	
166	Pop Pinball	
167	Cop Pop	Elec Pop
168	Elec Pop	
169	Breeze Ballad	Ballad
170	R&B Ballad 1	
171	R&B Ballad 2	
172	Slow Shuffle 1	
173	Slow Shuffle 2	
174	Slow 16Beat	
175	Slow Ballad 1	
176	Slow Ballad 2	
177	Slow Ballad 3	Soul
178	Very Slow	
179	Funky Soul 1	
180	Funky Soul 2	
181	Soul 1	
182	Soul 2	
183	Soul 3	
184	Soul 4	Funk
185	Peddler Funk	
186	Soul Funk	
187	Funk Machine	
188	Super Funk	
189	Oakland Funk	
190	House Funk	
191	Funky Boy	
192	Funk Pop	
193	Heavy Funk	
194	Fast Funk	
195	Funk Rock 1	
196	Funk Rock 2	
197	Funk Series A	
198	Funk Series B	
199	Funk Series C	
200	Funk Series D	
201	FunkStraight 1	
202	FunkStraight 2	
203	Perc Funk 1	
204	Perc Funk 2	
205	Perc Funk 3	
206	Speed Funk 1	

No.	Name	Category	
207	Speed Funk 2	Funk	
208	Pop Funk 1	Pop Funk	
209	Pop Funk 2		
210	Fusion Funk 1	Fusion Funk	
211	Fusion Funk 2		
212	FunkyShuffle 1	Shuffle Funk	
213	FunkyShuffle 2		
214	FunkyShuffle 3		
215	Gospel 1	Gospel	
216	Gospel 2		
217	Gospel 3		
218	Gospel Pop 1		
219	Gospel Pop 2	Country	
220	Gospel Pop 3		
221	Country 1		
222	Country 2	Train	
223	Country 3		
224	Country 4		
225	Train 1		
226	Train 2	Blue Grass	
227	Train 3		
228	Train 4		
229	Blue Grass 1	Go Go	
230	Blue Grass 2		
231	Blue Grass 3		
232	Go Go Rock 1	Twist	
233	Go Go Rock 2		
234	Twist 1	Charleston	
235	Twist 2		
236	Charleston 1	Brush Jazz	
237	Charleston 2		
238	It's Jazz!!		
239	Jazz Brush 1		
240	Jazz Brush 2		
241	Brush Pop 1		
242	Brush Pop 2		
243	Slow Brush 1		
244	Slow Brush 2		
245	Jazz Club 1		Jazz Club
246	Jazz Club 2		
247	Jazz Club 3		
248	Jazz Blues 1		Jazz Waltz
249	Jazz Blues 2		

Preset Data List

No.	Name	Category
250	Jazz Waltz 1	Jazz Waltz
251	Jazz Waltz 2	
252	Jazz Waltz 3	
253	6/8 Jazz	Jazz Ballad
254	Jazz Ballad	
255	Mid Blues 1	Jazz Blues
256	Mid Blues 2	
257	Mid Blues 3	
258	5/4 Jazz 1	5/4 Jazz
259	5/4 Jazz 2	
260	Foxtrot 1	Foxtrot
261	Foxtrot 2	
262	Foxtrot 3	Swing Foxtrot
263	SwingFoxtrot 1	
264	SwingFoxtrot 2	
265	SwingFoxtrot 3	
266	5/4 Swing	Swing
267	Swing 1	
268	Swing 2	
269	Swing 3	
270	Swing 4	Big Band
271	Big Jazz Hi	
272	Big Jazz Low	
273	Big Series A	
274	Big Series B	
275	Big Series C	
276	Big Series D	
277	Big Ballad 1	
278	Big Ballad 2	
279	Big Band 1	
280	Big Band 2	
281	Big Band 3	
282	Big Band 4	
283	Big Band 5	Fusion
284	16BeatFusion 1	
285	16BeatFusion 2	
286	16BeatFusion 3	
287	Groove Six	
288	8Beat Fusion	
289	Bound Fusion 1	
290	Bound Fusion 2	
291	Contemporary 1	
292	Contemporary 2	

No.	Name	Category
293	Fusion 1	Fusion
294	Fusion 2	
295	Pop Fusion	Pop Fusion
296	6/8 Fusion 1	6/8 Fusion
297	6/8 Fusion 2	
298	6/8 Fusion 3	
299	5/4 Fusion	5/4 Fusion
300	7/4 Fusion	7/4 Fusion
301	Reggae 1	Reggae
302	Reggae 2	
303	Reggae 3	
304	Reggae 4	
305	Samba 1	Samba
306	Samba 2	
307	Samba 3	
308	Samba 4	
309	Samba 5	
310	Samba 6	
311	Big Samba 1	Big Samba
312	Big Samba 2	
313	Big Samba 3	
314	Up Samba 1	Up Samba
315	Up Samba 2	
316	Rio Samba 1	Rio Samba
317	Rio Samba 2	
318	Bossa Nova 1	Bossa Nova
319	Bossa Nova 2	
320	Bossa Nova 3	
321	Bossa Nova 4	
322	Bossa Nova 5	
323	Bossa Nova 6	
324	Luv Bossa 1	Luv Bossa
325	Luv Bossa 2	
326	Up Bossa 1	Up Bossa
327	Up Bossa 2	
328	Brush Bossa 1	Brush Bossa
329	Brush Bossa 2	
330	Salsa 1	Salsa
331	Salsa 2	
332	Salsa 3	
333	Salsa 4	
334	Salsa 5	
335	Salsa 6	

No.	Name	Category
336	Salsa 7	Salsa
337	Pop Latin 1	Latin Pop
338	Pop Latin 2	
339	Pop Latin 3	
340	Pop Latin 4	
341	Pop Latin 5	
342	Latin Jam 1	
343	Latin Jam 2	Mambo
344	Mambo 1	
345	Mambo 2	
346	Mambo 3	
347	Mambo 4	Beguine
348	Beguine 1	
349	Beguine 2	Bachata
350	Bachata 1	
351	Bachata 2	
352	Bachata 3	Cha Cha Cha
353	Cha Cha Cha 1	
354	Cha Cha Cha 2	
355	Cha Cha Cha 3	Merengue
356	Merengue 1	
357	Merengue 2	Rhumba
358	Merengue 3	
359	Rhumba 1	Musette
360	Rhumba 2	
361	Musette 1	Waltz
362	Musette 2	
363	Waltz 1	Eng Waltz
364	Waltz 2	
365	Eng Waltz 1	Slow Waltz
366	Eng Waltz 2	
367	Slow Waltz 1	Polka
368	Slow Waltz 2	
369	Polka	Paso Doble
370	Polka Pop 1	
371	Polka Pop 2	
372	Polka Pop 3	Tango
373	Paso Doble 1	
374	Paso Doble 2	Tango
375	Paso Doble 3	
376	Tango 1	Tango
377	Tango 2	
378	Tango 3	

No.	Name	Category
379	R&B 1	R&B Dance
380	R&B 2	
381	R&B 3	
382	R&B 4	
383	R&B 5	
384	R&B 6	
385	R&B 7	
386	R&B 8	
387	R&B 9	
388	Street Hop	Hip Hop
389	Hip Hop 1	
390	Hip Hop 2	
391	Hip Hop 3	
392	Hip Hop 4	
393	Hip Hop 5	
394	Hip Hop 6	
395	Hip Hop 7	
396	Hip Hop 8	
397	Hip Hop 9	
398	Hip Hop 10	
399	Hip Reggae 1	
400	Hip Reggae 2	
401	Hip Reggae 3	
402	Rock Hop 1	
403	Rock Hop 2	
404	G-Funk 1	G-Funk
405	G-Funk 2	
406	G-Funk 3	
407	G-Funk 4	
408	G-Funk 5	
409	Abstract 1	Abstract
410	Abstract 2	
411	Abstract 3	
412	Abstract 4	
413	Cool House	House
414	House 1	
415	House 2	
416	House 3	
417	House 4	
418	Shuffle House	
419	Hard House 1	
420	Hard House 2	
421	Garage 1	Garage

No.	Name	Category
422	Garage 2	Garage
423	Break Beats 1	Break Beats
424	Break Beats 2	
425	Drum'n'Bass 1	Drum'n' Bass
426	Drum'n'Bass 2	
427	Drum'n'Bass 3	
428	Drum'n'Bass 4	
429	Two Step 1	Two Step
430	Two Step 2	
431	Techno 1	Techno
432	Techno 2	
433	Techno 3	
434	Techno 4	
435	Techno 5	
436	Dutch Trance	Trance
437	Euro Trance	
438	Hard Trance	Hard Trance
439	Hard Core	Hard Core
440	Disco	Disco
441	8Beat 1	8 Beat
442	8Beat 2	
443	8Beat 3	
444	8Beat 4	
445	8Beat 5	
446	8Beat 6	
447	8Beat 7	
448	8Beat 8	
449	8Beat 9	
450	8Beat 10	
451	8Beat 11	
452	8Beat 12	
453	8Beat 13	
454	8Beat 14	
455	8Beat 15	
456	16Beat 1	16 Beat
457	16Beat 2	
458	16Beat 3	
459	16Beat 4	
460	16Beat 5	
461	16Beat 6	
462	16Beat 7	
463	16Beat 8	
464	16Beat 9	

No.	Name	Category
465	Shuffle 1	Shuffle
466	Shuffle 2	
467	Shuffle 3	
468	Shuffle 4	
469	Shuffle 5	
470	Shuffle 6	
471	Shuffle 7	
472	Shuffle 8	
473	Shuffle 9	
474	Shuffle 10	
475	Shuffle 11	
476	Fast Shuffle 1	Fast Shuffle
477	Fast Shuffle 2	
478	6/8 Slow 1	6/8 Beat
479	6/8 Slow 2	
480	6/8 Slow 3	
481	Intro 1	Intro
482	Intro 2	
483	Intro 3	
484	Intro 4	
485	Intro 5	
486	Intro 6	
487	Intro 7	
488	Intro 8	
489	Intro 9	
490	Intro 10	
491	Ending 1	Ending
492	Ending 2	
493	Ending 3	
494	Ending 4	
495	Ending 5	
496	Ending 6	
497	Ending 7	
498	Ending 8	
499	Ending 9	
500	Ending 10	

Dr. Rhythm

Model DR-880

MIDI Implementation Chart

Date: Aug. 11, 2004
Version: 1.00

Function...	Transmitted	Recognized	Remarks
Basic Channel	1-16 1-16	1-16 1-16	Memorized
Mode	Mode 3 X *****	Mode 3 X	
Note Number:	0-127 *****	0-127 0-127	*1 *2
Velocity	0 9n V=1-127 X	0 X	
After Touch	X X	X X	
Pitch Bend	0	0	
Control Change	7 0 6, 38 100, 101	X 0 0 0 0	Volume Bank Select Data Entry RPN MSB, LSB *3 *4

Program Change	: True Number	O *****	O		Kit Change
System Exclusive		O	O		
System Common	: Song Position : Song Select : Tune Request	O O X	*5 *5 X	*6 *6	0-99
System Realtime	: Clock : Commands	O O	*5 *5	*7 *6	
Aux Messages	: Local On/Off : All Notes Off : All Sound Off : Reset All Controllers : Active Sensing : System Reset	X X X X O X		X X X X O X	
Notes		<p>*1 Relationship between Percussion instrument and Note number is common to transmit and receive. *2 Some sounds may not play at the correct pitch. *3 Can be set to O or X. *4 Used to specify preset/user kits. *5 When Sync mode is MIDI, this message can not transmitted. *6 When Sync mode is INTERNAL, this message can not received. *7 When Sync mode is INTERNAL or REMOTE, this message can not received.</p>			

Mode 1: OMNI ON, POLY
Mode 2: OMNI ON, MONO
Mode 3: OMNI OFF, POLY
Mode 4: OMNI OFF, MONO

O: Yes
X: No

Specifications

DR-880: Dr.Rhythm

Maximum Polyphony

32 voices

* Depending on the bass tone used, maximum polyphony may be lower.

Instruments

Drum: 440

Bass: 40

Kits

Preset: 100

User: 100

Patterns

Preset: 500

User: 500

Songs

User: 100

Maximum Note Storage

Approx. 30,000 notes

* This may be smaller than this depending on the contents of created pattern and song.

Resolution

Per quarter note: 96

Tempo

Quarter note: 20–260 bpm

Pads

20 with velocity sensitive

Display

Custom LCD with backlight

Connectors

(Rear)

Master Out L (MONO), R (1/4" Phone Type)

Master Out L, R (Phono Type)

Individual A, B (1/4" Phone Type)

Digital Out (coaxial)

CTL 1,2 (TRS 1/4" Phone Type)

CTL 3,4/EXP PEDAL (TRS 1/4" Phone Type)

USB

MIDI IN, OUT

AC Adaptor

(Front)

Phones (Stereo 1/4" Phone Type)

Guitar/Bass Input (1/4" Phone Type)

Power Supply

AC Adaptor (BRC series)

Power Consumption

600 mA (Max.)

Dimensions

273 (W) x 242 (D) x 72 (H) mm

10-3/4 (W) x 9-9/16 (D) x 2-7/8 (H) inches

Weight

1.4 kg / 3 lbs 2 oz (excluding AC adaptor)

Accessories

AC Adaptor

Owner's Manual

DR-880 Driver CD-ROM

Roland Service (Information sheet)

Options

Foot Switch (FS-5U)

Dual Foot Switch (FS-6)

Expression Pedal (Roland EV-5)

Foot Switch Cable (Roland PCS-31)

(stereo 1/4" phone plug–1/4" phone plug x 2)

* In the interest of product improvement, the specifications and/or appearance of this unit are subject to change without prior notice.

Index

Symbols

*TMP 87, 100, 106, 110

A

AC IN 16
ACO MULTI 43, 92
Acoustic Multi 43
ACOUSTIC PROCESSOR 98
Algorithm 43, 86
AMB 100
Ambience 119
Ambience/Reverb 100–101
AMP SIM 112
Arrange 39, 53
Attack Lev 110
AUTO 128
A-WAH 94

B

B. DUMP 131
B. LOAD 132
BACKUP 138–139
Backup 133, 138
BANK 15, 116–117
Bank Number 127
Bank Select 127
BASS 13, 55, 57, 68, 72
BASS +1 41, 46
BASS -1 41, 46
BASS AMP SIM 97
Bass Amp Simulator 112
BASS MULTI 43, 92
Bass Multi 43
Bass Pad 46
BASS PART 106
Bass Part 25, 38, 55, 105, 110, 120
Bass Tone 40
BEAT 68
Beat 53
Bend Range 127
Bulk Dump 131
Bulk Load 132

C

CHORD 58
CHORD PROGRESSION 15, 69
Chord Progression 38–39, 58, 69
CHORUS 94
CLEAR 66, 80
Clear 80
COMMON 108
COMP 109, 111
COMPRESSOR 94, 96
Compressor 109, 111
Contrast 20

COPY 61, 66, 80, 89, 104, 114
Copy 61, 66, 80, 89, 104, 114
Copy Mode 62
COSM 11, 93, 97, 112
Count-In 123
CTL 1, 2 16, 121
CTL 3, 4/EXP PEDAL 16, 91, 121
Current 68–69
CURSOR 14

D

D. Out Lev 119
Data Block 131
Decay Lev 107, 110
Decay Time 107
DecayTime1 110
DecayTime2 110
DELAY 96
DELETE 64
Delete 64, 78
Depth 71–73
Dest Meas 61–64
Device ID 131
DIGITAL OUT 16, 45
DISPLAY 14, 47, 51, 83
Display 13, 20
Driver 143
DRUM 13, 55
DRUM 1, 2, 3 41, 46
DRUM PART 106
Drum Part 25, 38, 55, 105
DUR 57

E

EDIT 14
EFFECT 13, 33, 86
Effect Patch 43, 86
EFFECT TYPE 86
ENTER 14
EQ 100, 108
EQUALIZER 98
Equalizer 108
ERASE 63, 78
Erase 63, 66, 80
EXIT 14
Expression Pedal 91
EZ COMPOSE 15, 68–70
EZ Compose 67–68

F

FACTORY RESET 146
Factory Reset 146
Fast-Forward (▶▶) 14
FAVORITE 15, 116–117
FILL 60

FILL IN	15, 60, 70
Fill-In	38, 60, 70
FLANGER	95
FOOT SWITCH	122
Foot Switch	121
FS-5U	121
FS-6	121
FX	43, 92

G

GFX	117
GHOST NOTE	72
Ghost Note	72
GROOVE	71–73
GROOVE MODIFY	15
Groove Modify	67, 71
GTR MULTI	43, 92
GUITAR	119
GUITAR AMP	119
GUITAR AMP/ACOUSTIC SIM	93
Guitar Multi	43
GUITAR/BASS INPUT	13, 15, 32, 85

H

HH CYM	68
HH/Cym	71
High EQ	119

I

IFX (BASS)	110
IFX (KICK)	107
IFX (OTHERS)	107
IFX (SNARE)	107
IMPORT	135, 137
Import	133, 135
IND. A	107–108, 110–111
IND. A+B	108, 110–111, 119
IND. B	107–108, 110–111
INDIVIDUAL	16, 45
INFO	53, 76
Init.Tempo	76
INS. FX	108, 111
INSERT	62
Insert	62, 78
Insert Effect	40
Inst	61, 63, 107, 123
Install	143
Instrument	23, 40
INTERNAL	128
INTERVAL	70

K

KEY	15, 27, 50, 69, 82
Key	27, 50, 53, 82
Key Pad	15, 23

Key Shift	27, 50, 53, 77, 82
Kick	71
KICK SNR	68
KIT	13, 28, 68–70, 106
Kit	28, 38–40, 123
Kit Edit	105
kit Name	113
Kit Number	53, 77
Kit Select	77
Kit SelMod	123

L

LARGE	70
LCD	20
Level	107, 110, 123
LINE/PHONES	119
LINK	123–124
LOOP	14, 82
Loop	82
Loop End	77, 82
Loop Start	77, 82
Low EQ	119

M

MANUAL	123–124
MASTER	107–108, 110–111, 119
Master	128
MASTER OUT	16, 45
MASTER TUNE	91, 120
MASTER VOLUME	13
Maximum Polyphony	41
MEAS	68
Measures	53, 123
MERGE	62
MIDI	16, 125–126, 128, 131, 134
MIDI Ch. Bass	126, 135, 137
MIDI Ch. Drum	126, 135, 137
MIDI Channel	126
MIDI Communication	133, 143
MIDI IN	125
MIDI OUT	125
MODE	134
Mute Group	107

N

NAME	65, 79, 88, 103, 113
ND. A+B	107
NOISE SUPPRESSOR	93
NORM	56
NOTE	55, 57
NOTE DATA FIX	65
Note Message	127
Note Number	127
Num of Meas	61–64

O

OCT	56
OCT. SHIFT	59
ON-BASS	59
Operating System	134
OS	134
Out Assign	45, 107–108, 110–111
Output Assign	45
Output Sel	119
OUTPUT SETTING	13, 119
Output Setting	45, 119

P

P.BEND	57
PAD	14, 23, 46, 57, 107, 120
Pad Bank	23, 41, 46
Pad Parameter	107
Pad Sens	120
PAN	95
Pan	107–108, 110–111
Part	61, 63
PART COMMON	106, 110
PART LEVEL	13
Part Level	106
Patch Edit	86
PATCH LEVEL	86
Patch Name	88, 103
PATTERN	15, 24, 49, 53, 68
Pattern	24, 38–39, 68
Pattern Mode	49
Pattern Name	38, 65
Pattern Play Screen	19, 47
PERC	68
Perc	71
PHASER	95
PHONES	15
Pit. Coarse	107
PITCH BEND	55
Pitch Bend	57, 127
Pitch Fine	107
Play (▶)	14
PLAY OPTION	123–124
POSITION	56, 58, 60, 77
POWER	16
PowerOnPtn	124
Preset Kit	28, 40
Preset Patch	30, 33, 42–43
Preset Pattern	24
Program Change	127
Program Number	127
PTN	117
P-WAH	94

Q

Qtz	56–58
Quantize	54

R

RANGE	58
Rate	73
Realtime Recording	52
REC	14
Rec Rehearsal	54
Rec Standby	54
Rec. Velo	54
Rec.Key	53
Recording	54–55
RECOVER	141–142
Recover	133, 141
REC-VEL	56
Reference Pitch	91, 120
Rel. Time	107, 110
REMOTE	128
REPLACE	62
Reset (◀)	14
Resolution	73
Rev. Send	107–108, 110–111
REVERB	96
Rewind (◀◀)	14
ROOT	59
Rx MIDI Vol	126

S

Save	65, 79, 88, 103, 113
SENS	54, 56
SETTING	126, 128, 131
Shelving	101
SHIFT	14
SHUFFLE	72–73
Shuffle	73
Slave	128
SMALL	70
SMF	133, 135
Snare	71
SNG	117
SONG	75
Song	39
Song Mode	75
Song Name	79
Song Play Screen	47
SONG/PATTERN	13, 24
Src	61
Src Meas	61
STEP REC	55, 77
Step Recording	52, 76
Stereo EQ	100–101
Stop (■)	14
STORAGE	134

STRAIGHT	72
Sync Mode	128
Synchronize	128

T

Tap Tempo	50, 81
Template	71–72
Tempo	26, 38–39, 50, 53, 81
TEMPO (TAP)	15, 26, 50, 81
TIMES	69
Times	62
Tone	110
Total Sound Control	15, 30, 42
TREMOLO	95
TSC	15, 30, 38–39, 42, 99–100
TSC Number	53, 77
TSC Patch	30, 38–39, 42, 100, 123
TSC Select	77
TSC SelMod	124
TSC Switch	53, 77
TUNER	13, 90
tuning	90
T-WAH	97
TYPE	59, 68–69

U

USB	16, 134, 137–139, 141–142
USB MIDI Driver	143
User Kit	28, 40
User Patch	30, 33, 42–43
User Pattern	24

V

VALUE	13, 47, 58
VEL	57
Velocity Balance	71
Velocity Modify	71
Voice	41
Volume Message	126

W

WRITE	65, 79, 88, 103, 113, 118
Write	65, 79, 88, 103, 113

For the U.K.

IMPORTANT: THE WIRES IN THIS MAINS LEAD ARE COLOURED IN ACCORDANCE WITH THE FOLLOWING CODE.

BLUE: NEUTRAL
BROWN: LIVE

As the colours of the wires in the mains lead of this apparatus may not correspond with the coloured markings identifying the terminals in your plug, proceed as follows:

The wire which is coloured BLUE must be connected to the terminal which is marked with the letter N or coloured BLACK.
The wire which is coloured BROWN must be connected to the terminal which is marked with the letter L or coloured RED.
Under no circumstances must either of the above wires be connected to the earth terminal of a three pin plug.

For EU Countries



This product complies with the requirements of European Directive 89/336/EEC.

For the USA

FEDERAL COMMUNICATIONS COMMISSION RADIO FREQUENCY INTERFERENCE STATEMENT

This equipment has been tested and found to comply with the limits for a Class B digital device, pursuant to Part 15 of the FCC Rules. These limits are designed to provide reasonable protection against harmful interference in a residential installation. This equipment generates, uses, and can radiate radio frequency energy and, if not installed and used in accordance with the instructions, may cause harmful interference to radio communications. However, there is no guarantee that interference will not occur in a particular installation. If this equipment does cause harmful interference to radio or television reception, which can be determined by turning the equipment off and on, the user is encouraged to try to correct the interference by one or more of the following measures:

- Reorient or relocate the receiving antenna.
- Increase the separation between the equipment and receiver.
- Connect the equipment into an outlet on a circuit different from that to which the receiver is connected.
- Consult the dealer or an experienced radio/TV technician for help.

This device complies with Part 15 of the FCC Rules. Operation is subject to the following two conditions:

- (1) This device may not cause harmful interference, and
- (2) This device must accept any interference received, including interference that may cause undesired operation.

Unauthorized changes or modification to this system can void the users authority to operate this equipment.
This equipment requires shielded interface cables in order to meet FCC class B Limit.

For Canada

NOTICE

This Class B digital apparatus meets all requirements of the Canadian Interference-Causing Equipment Regulations.

AVIS

Cet appareil numérique de la classe B respecte toutes les exigences du Règlement sur le matériel brouilleur du Canada.

For the USA

DECLARATION OF CONFORMITY Compliance Information Statement

Model Name : DR-880
Type of Equipment : Dr. Rhythm
Responsible Party : Roland Corporation U.S.
Address : 5100 S.Eastern Avenue, Los Angeles, CA 90040-2938
Telephone : (323) 890-3700

