



GT-100

COSM AMP EFFECTS PROCESSOR

Owner's Manual



How to obtain a PDF of the owner's manual

PDF files of the owner's manual and supplementary material for this product can be obtained from the Roland website.

- GT-100 Owner's Manual (this document)
- GT-100 Parameter Guide *

*These are not included with the product; you may download them as necessary.

Visit the following URL, choose "owner's manuals," and search for the model name "GT-100."

<http://www.roland.com/support/en/>

USING THE UNIT SAFELY

Before using this unit, carefully read the sections entitled: "USING THE UNIT SAFELY" and "IMPORTANT NOTES" (p. 4). These sections provide important information concerning the proper operation of the unit. Additionally, in order to feel assured that you have gained a good grasp of every feature provided by your new unit, Owner's manual should be read in its entirety. The manual should be saved and kept on hand as a convenient reference.

Copyright © 2012 BOSS CORPORATION

All rights reserved. No part of this publication may be reproduced in any form without the written permission of BOSS CORPORATION.

INSTRUCTIONS FOR THE PREVENTION OF FIRE, ELECTRIC SHOCK, OR INJURY TO PERSONS

About ⚠ WARNING and ⚠ CAUTION Notices

| | |
|------------------|--|
| ⚠ WARNING | Used for instructions intended to alert the user to the risk of death or severe injury should the unit be used improperly. |
| ⚠ CAUTION | Used for instructions intended to alert the user to the risk of injury or material damage should the unit be used improperly. * Material damage refers to damage or other adverse effects caused with respect to the home and all its furnishings, as well to domestic animals or pets. |

About the Symbols

| | |
|--|--|
| | The ⚠ symbol alerts the user to important instructions or warnings. The specific meaning of the symbol is determined by the design contained within the triangle. In the case of the symbol at left, it is used for general cautions, warnings, or alerts to danger. |
| | The ⓧ symbol alerts the user to items that must never be carried out (are forbidden). The specific thing that must not be done is indicated by the design contained within the circle. In the case of the symbol at left, it means that the unit must never be disassembled. |
| | The Ⓢ symbol alerts the user to things that must be carried out. The specific thing that must be done is indicated by the design contained within the circle. In the case of the symbol at left, it means that the power-cord plug must be unplugged from the outlet. |

ALWAYS OBSERVE THE FOLLOWING

⚠ WARNING

Do not disassemble or modify by yourself

Do not open (or modify in any way) the unit or its AC adaptor.



Do not repair or replace parts by yourself

Do not attempt to repair the unit, or replace parts within it (except when this manual provides specific instructions directing you to do so). Refer all servicing to your retailer, the nearest Roland Service Center, or an authorized Roland distributor, as listed on the "Information" page.



Do not use or store in the following types of locations

- Subject to temperature extremes (e.g., direct sunlight in an enclosed vehicle, near a heating duct, on top of heat-generating equipment); or are
- Damp (e.g., baths, washrooms, on wet floors); or are
- Exposed to steam or smoke; or are
- Subject to salt exposure; or are
- Humid; or are
- Exposed to rain; or are
- Dusty or sandy; or are
- Subject to high levels of vibration and shakiness.



⚠ WARNING

Do not place in an unstable location

Make sure you always have the unit placed so it is level and sure to remain stable. Never place it on stands that could wobble, or on inclined surfaces.



Use only the included AC adaptor and the correct voltage

Be sure to use only the AC adaptor included with the unit. Also, make sure the line voltage at the installation matches the input voltage specified on the AC adaptor's body. Other AC adaptors may use a different polarity, or be designed for a different voltage, so their use could result in damage, malfunction, or electric shock.



Use only the included power cord

Use only the attached power-supply cord. Also, the included power cord must not be used with any other device.



Do not bend the power cord or place heavy objects on it

Do not excessively twist or bend the power cord, nor place heavy objects on it. Doing so can damage the cord, producing severed elements and short circuits. Damaged cords are fire and shock hazards!



⚠ WARNING

Avoid extended use at high volume

This unit, either alone or in combination with an amplifier and headphones or speakers, may be capable of producing sound levels that could cause permanent hearing loss. Do not operate for a long period of time at a high volume level, or at a level that is uncomfortable. If you experience any hearing loss or ringing in the ears, you should immediately stop using the unit, and consult an audiologist.



Don't allow foreign objects or liquids to enter unit; never place containers with liquid on unit

Do not place containers containing liquid on this product. Never allow foreign objects (e.g., flammable objects, coins, wires) or liquids (e.g., water or juice) to enter this product. Doing so may cause short circuits, faulty operation, or other malfunctions.



! WARNING

Turn off the unit if an abnormality or malfunction occurs

Immediately turn the unit off, remove the AC adaptor from the outlet, and request servicing by your retailer, the nearest Roland Service Center, or an authorized Roland distributor, as listed on the "Information" page when:



- The AC adaptor, the power-supply cord, or the plug has been damaged; or
- If smoke or unusual odor occurs; or
- Objects have fallen into, or liquid has been spilled onto the unit; or
- The unit has been exposed to rain (or otherwise has become wet); or
- The unit does not appear to operate normally or exhibits a marked change in performance.

Adults must provide supervision in places where children are present

When using the unit in locations where children are present, be careful so no mishandling of the unit can take place. An adult should always be on hand to provide supervision and guidance.



Do not drop or subject to strong impact

Protect the unit from strong impact. (Do not drop it!)



Do not share an outlet with an unreasonable number of other devices

Do not force the unit's power-supply cord to share an outlet with an unreasonable number of other devices. Be especially careful when using extension cords—the total power used by all devices you have connected to the extension cord's outlet must never exceed the power rating (watts/amperes) for the extension cord. Excessive loads can cause the insulation on the cord to heat up and eventually melt through.



Do not use overseas

Before using the unit in a foreign country, consult with your retailer, the nearest Roland Service Center, or an authorized Roland distributor, as listed on the "Information" page.



! CAUTION

Place in a well ventilated location

The unit and the AC adaptor should be located so their location or position does not interfere with their proper ventilation.



Grasp the plug when connecting or disconnecting the AC adaptor

Always grasp only the plug on the AC adaptor cord when plugging into, or unplugging from, an outlet or this unit.



Periodically clean the AC adaptor's plug

At regular intervals, you should unplug the AC adaptor and clean it by using a dry cloth to wipe all dust and other accumulations away from its prongs. Also, disconnect the power plug from the power outlet whenever the unit is to remain unused for an extended period of time. Any accumulation of dust between the power plug and the power outlet can result in poor insulation and lead to fire.



Manage cables for safety

Try to prevent cords and cables from becoming entangled. Also, all cords and cables should be placed so they are out of the reach of children.



Avoid climbing on top of the unit, or placing heavy objects on it

Never climb on top of, nor place heavy objects on the unit.



Do not connect or disconnect the AC adaptor with wet hands

Never handle the AC adaptor or its plugs with wet hands when plugging into, or unplugging from, an outlet or this unit.



Disconnect everything before moving the unit

Before moving the unit, disconnect the AC adaptor and all cords coming from external devices.



Unplug the AC adaptor from the outlet before cleaning

Before cleaning the unit, turn it off and unplug the AC adaptor from the outlet (p. 24).



If there is a possibility of lightning strike, disconnect the AC adaptor from the outlet

Whenever you suspect the possibility of lightning in your area, disconnect the AC adaptor from the outlet.



! CAUTION

Take care not to get fingers pinched by lid

Be careful so you don't get your fingers pinched when you handle any moving parts such as the following. Adult supervision is recommended whenever small children use the unit.



- Expression Pedal (p. 20)

Keep small items out of the reach of children

To prevent accidental ingestion of the parts listed below, always keep them out of the reach of small children.



- Removable Parts
USB Cap (p. 23)

Handle the ground terminal carefully

If you remove the screw from the ground terminal, be sure to replace it; don't leave it lying around where it could accidentally be swallowed by small children. When refastening the screw, make that it is firmly fastened, so it won't come loose.



IMPORTANT NOTES

Power Supply

- Do not connect this unit to same electrical outlet that is being used by an electrical appliance that is controlled by an inverter or a motor (such as a refrigerator, washing machine, microwave oven, or air conditioner). Depending on the way in which the electrical appliance is used, power supply noise may cause this unit to malfunction or may produce audible noise. If it is not practical to use a separate electrical outlet, connect a power supply noise filter between this unit and the electrical outlet.
- The AC adaptor will begin to generate heat after long hours of consecutive use. This is normal, and is not a cause for concern.
- To prevent malfunction and equipment failure, always make sure to turn off the power on all your equipment before you make any connections.
- With the factory settings, the GT-100 will automatically be switched off 10 hours after you stop playing or operating the unit. If you don't want the unit to turn off automatically, change the "AUTO OFF" setting to "OFF" as described on p. 42.
- * The settings you were editing will be lost when the unit is turned off. If you want to keep your settings, you must save your settings before turning the unit off.

Placement

- Using the unit near power amplifiers (or other equipment containing large power transformers) may induce hum. To alleviate the problem, change the orientation of this unit; or move it farther away from the source of interference.
- This device may interfere with radio and television reception. Do not use this device in the vicinity of such receivers.
- Noise may be produced if wireless communications devices, such as cell phones, are operated in the vicinity of this unit. Such noise could occur when receiving or initiating a call, or while conversing. Should you experience such problems, you should relocate such wireless devices so they are at a greater distance from this unit, or switch them off.
- Do not expose the unit to direct sunlight, place it near devices that radiate heat, leave it inside an enclosed vehicle, or otherwise subject it to temperature extremes. Excessive heat can deform or discolor the unit.
- When moved from one location to another where the temperature and/or humidity is very different, water droplets (condensation) may form inside the unit. Damage or malfunction may result if you attempt to use the unit in this condition. Therefore, before using the unit, you must allow it to stand for several hours, until the condensation has completely evaporated.

- Depending on the material and temperature of the surface on which you place the unit, its rubber feet may discolor or mar the surface. You can place a piece of felt or cloth under the rubber feet to prevent this from happening. If you do so, please make sure that the unit will not slip or move accidentally.
- Do not put anything that contains water on this unit. Also, avoid the use of insecticides, perfumes, alcohol, nail polish, spray cans, etc., near the unit. Swiftly wipe away any liquid that spills on the unit using a dry, soft cloth.

Maintenance

- For everyday cleaning wipe the unit with a soft, dry cloth or one that has been slightly dampened with water. To remove stubborn dirt, use a cloth impregnated with a mild, non-abrasive detergent. Afterwards, be sure to wipe the unit thoroughly with a soft, dry cloth.
- Never use benzine, thinners, alcohol or solvents of any kind, to avoid the possibility of discoloration and/or deformation.

Repairs and Data

- Please be aware that all data contained in the unit's memory may be lost when the unit is sent for repairs. Important data should always be backed up computer, in another MIDI device, or written down on paper (when possible). During repairs, due care is taken to avoid the loss of data. However, in certain cases (such as when circuitry related to memory itself is out of order), we regret that it may not be possible to restore the data, and Roland assumes no liability concerning such loss of data.

Additional Precautions

- Please be aware that the contents of memory can be irretrievably lost as a result of a malfunction, or the improper operation of the unit. To protect yourself against the risk of losing important data, we recommend that you periodically save a backup copy of important data you have stored in the unit's memory on a computer, or in another MIDI device.
- Unfortunately, it may be impossible to restore the contents of data that was stored in the unit's memory, on a computer, or in another MIDI device once it has been lost. Roland Corporation assumes no liability concerning such loss of data.
- Use a reasonable amount of care when using the unit's buttons, sliders, or other controls; and when using its jacks and connectors. Rough handling can lead to malfunctions.
- Never strike or apply strong pressure to the display.
- When disconnecting all cables, grasp the connector itself—never pull on the cable. This way you will avoid causing shorts, or damage to the cable's internal elements.

- To avoid disturbing others nearby, try to keep the unit's volume at reasonable levels. You may prefer to use headphones, so you do not need to be concerned about those around you.
- When you need to transport the unit, package it in the box (including padding) that it came in, if possible. Otherwise, you will need to use equivalent packaging materials.
- Use only the specified expression pedal (Roland EV-5, BOSS FV-500L, BOSS FV-500H; sold separately). By connecting any other expression pedals, you risk causing malfunction and/or damage to the unit.
- Some connection cables contain resistors. Do not use cables that incorporate resistors for connecting to this unit. The use of such cables can cause the sound level to be extremely low, or impossible to hear. For information on cable specifications, contact the manufacturer of the cable.
- When you operate the expression pedal, please be careful not to get your fingers pinched between the movable part and the panel. In places where small children are present, make sure that an adult provides supervision and guidance.

Copyright

- It is forbidden by law to make an audio recording, video recording, copy or revision of a third party's copyrighted work (musical work, video work, broadcast, live performance, or other work), whether in whole or in part, and distribute, sell, lease, perform, or broadcast it without the permission of the copyright owner.
- Do not use this product for purposes that could infringe on a copyright held by a third party. We assume no responsibility whatsoever with regard to any infringements of third-party copyrights arising through your use of this product.
- Company names and product names appearing in this document are registered trademarks or trademarks of their respective owners.
- MMP (Moore Microprocessor Portfolio) refers to a patent portfolio concerned with microprocessor architecture, which was developed by Technology Properties Limited (TPL). Roland has licensed this technology from the TPL Group.
- This product contains eCROS integrated software platform of eSOL Co., Ltd. eCROS is a trademark of eSOL Co., Ltd. in Japan.
- Roland, BOSS, COSM, Metal Zone and SLICER are either registered trademarks or trademarks of Roland Corporation in the United States and/or other countries.

Main Features

New COSM Amps

These newly remodeled COSM amps offer a distillation of all the sound creation know-how that we've built up over the years. They represent a further evolution that goes beyond conventional vintage amp modeling. From pristinely transparent clean sounds, to extreme high-gain sounds, these models allow your picking to freely control the amp's dynamic behavior and its subtle nuances.



Intuitive Two-Screen User Interface

Two graphic LCD displays are used; select a menu item in the left screen, and immediately edit the parameters in the right screen. Knobs, switches, amps, and effects are shown as icons, allowing direct, easy-to-grasp operation.

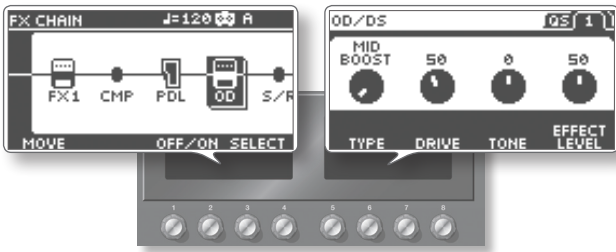

EZ TONE for Easy Sound Creation

Creating your own patch or amp setup is easy; simply select a musical style or a type of sound, and use the tone grid screen to visually adjust the character and the amount of distortion.

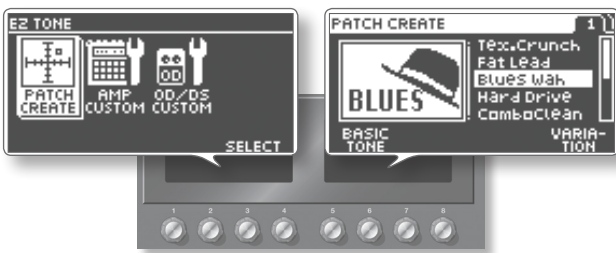

Accel Effect for Powerful Live Performance

Simply press the [ACCEL] pedal to add an aggressive sound effect that changes over time.

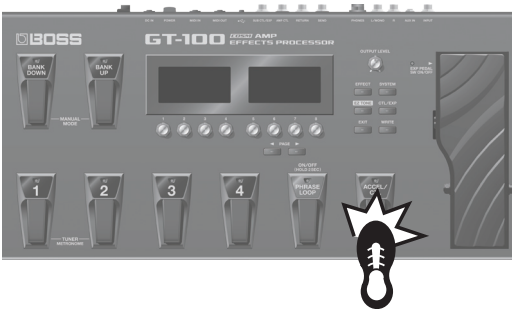

Easy-Operation Looper

The basic looper operations are controlled by a single dedicated pedal. In addition to the conventional method in which the effect-processed sound is recorded, you can also record the unprocessed sound and then apply effects later for comparison, or use the recording for a sound check during rehearsal on stage.

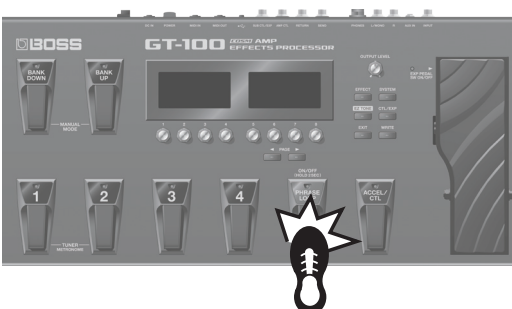

Contents

| | |
|--|-----------|
| USING THE UNIT SAFELY | 2 |
| IMPORTANT NOTES | 4 |
| Main Features | 5 |
| Quick Guide | 8 |
| Panel Descriptions | 20 |
| Front Panel | 20 |
| About the Play Screen | 21 |
| Rear Panel (Connections) | 22 |
| Outputting Sounds | 24 |
| Switching the Unit On and Off | 24 |
| Adjusting the Output Level | 24 |
| Specifying the Output Device (Output Select) | 24 |
| Tuning the Guitar (TUNER) | 24 |
| Using the Metronome | 25 |
| Selecting a Tone (Patch Change) | 25 |
| How a Patch Is Structured | 25 |
| Using the Pedal to Select the Patch | 26 |
| Using the Knobs to Select a Patch | 26 |
| Creating Sounds (Effects) | 27 |
| Setting the Effects | 27 |
| Specifying the Divider and Mixer Modes | 27 |
| Using Amp Control | 28 |
| Using Send/Return | 29 |
| Saving a Tone | 30 |
| Saving a Patch (PATCH WRITE) | 30 |
| Exchanging Patches (PATCH EXCHANGE) | 30 |
| Initializing Patches (PATCH INITIALIZE) | 30 |
| Storing Settings by Effect (Quick Setting Write) | 31 |
| Copying or Swapping PREAMP Settings Between Channels | 31 |
| Phrase Loop Play | 32 |
| Setting Phrase Loop | 32 |
| Pedal Settings (Control/Expression) | 33 |
| Using Pedals to Control the Parameters | 33 |
| Assigning the ACCEL/CTL, EXP SW, SUB CTL1, and SUB CTL2 Functions | 33 |
| Assigning the EXP and SUB EXP Pedal Functions | 34 |
| Assigning the [1]–[8] Knob Functions in the Play Screen | 35 |
| Switching Settings with the Number Pedals | 35 |
| Adjusting the [EXP] pedal | 36 |
| Setting Each Pedal Functions to Individual Patches (Assign) | 37 |
| Virtual expression pedal system (Internal Pedal / Wave Pedal) | 39 |
| Input Level | 39 |
| Making Global Settings (System Settings) | 40 |
| List of Settings | 40 |
| Specifying the Output Device You're Using (OUTPUT SELECT) | 40 |
| Adjusting the Input Level from Your Guitar | 40 |
| Adjusting the Overall Tone (Global EQ) | 40 |
| Adjusting the Overall Noise Suppressor, Reverb, and Output Level (Total) | 40 |
| Making Phrase Loop (p. 32) Settings | 40 |
| Making the PLAY OPTION Settings | 41 |
| Assigning the [1]–[8] Knob Functions in the Play Screen | 41 |
| Specifying Whether Settings Will Be Shared by All Patches | 41 |
| Adjusting the Contrast (Brightness) of the LCD Screen | 41 |
| Adjusting the [EXP] pedal | 41 |
| Auto Off Settings | 42 |
| Restoring the Factory Settings (Factory Reset) | 42 |
| USB-Related Settings | 43 |
| Setting the USB audio flow | 43 |
| Setting the MIX LEVEL | 43 |
| Setting the INPUT LEVEL | 43 |
| Setting the OUTPUT LEVEL | 44 |
| Setting the Direct Monitor | 44 |
| Controlling the Direct Monitor Setting from a Computer | 44 |
| MIDI-Related Settings | 44 |
| Setting the MIDI Receive Channel | 44 |
| Setting the MIDI Omni Mode | 44 |
| Setting the MIDI Transmit Channel | 44 |
| Setting the MIDI Device ID | 44 |
| Setting the MIDI Sync Clock | 44 |
| Selecting the Connector That Will Receive MIDI Messages | 45 |
| Sending Program Change Messages | 45 |
| Enabling/Disabling the Program Change Map Settings (MIDI Map Select) | 45 |
| Sending [PHRASE LOOP] Pedal Operations as Control Change Messages | 45 |
| Sending [ACCEL/CTL] Pedal Operations as Control Change Messages | 45 |
| Sending [EXP] Pedal Operations as Control Change Messages | 45 |
| Sending EXP Pedal Sw Operations as Control Change Messages | 45 |
| Sending External Footswitch Operations as Control Change Messages | 45 |
| Sending External Expression pedal Operations as Control Change Messages | 46 |
| Setting the Program Change Map | 46 |
| Transmitting Data to an External MIDI Device | 46 |
| Using the GT-100 with External MIDI Devices Connected | 47 |
| What Can You Do with MIDI? | 47 |
| Operating From the GT-100 | 47 |
| Remotely Controlling the GT-100 Using an External MIDI Device | 47 |
| Setting the Program Change Map | 47 |
| Transmitting Data to an External MIDI Device (Bulk Dump) | 48 |
| Making Connections | 48 |
| Transmitting the Data | 48 |

| | |
|--|-----------|
| Using the GT-100 Connected to a Computer Via USB | 49 |
| Before Connecting with USB | 49 |
| Installing the USB Driver | 49 |
| Exchanging MIDI Messages between the Computer and the GT-100 | 49 |
| Connecting the Computer | 49 |
| Receiving Bulk Data That Was Saved on the Computer .. | 49 |
| Transmitting/Receiving Audio Signals Between a Computer and the GT-100 | 49 |
| Restoring the Factory Settings (Factory Reset) | 50 |
| Appendices | 51 |
| GT-100 Effects Guide | 51 |
| GT-100 Effects List | 51 |
| OD/DS Type List | 52 |
| Preamp Type List | 52 |
| FX1/FX2 Effects List | 53 |
| GT-100 Preset Patch List | 54 |
| Signal Flow | 60 |
| Troubleshooting | 61 |
| Error Messages | 62 |
| Main Specifications | 63 |
| Index | 64 |

Quick Guide

Overview

Outputting Sound

Effects

Saving

Pedal Settings

System

MIDI/USB

Appendices

1

Getting Ready

This Quick Guide explains basic operation.

For details, refer to the pages shown by the **page XX** symbol.

1

Connect your guitar and amp.

For details, see **page 22**

Connect your guitar and amp.

Minimize the volume!

Turn off the power to the GT-100 and your amp, and set the volume to the minimum.



2

Turn on the power

For details, see **page 24**

1. Connect the AC adaptor.
2. Turn the [POWER] switch on.
3. Turn on the power to your guitar amp.

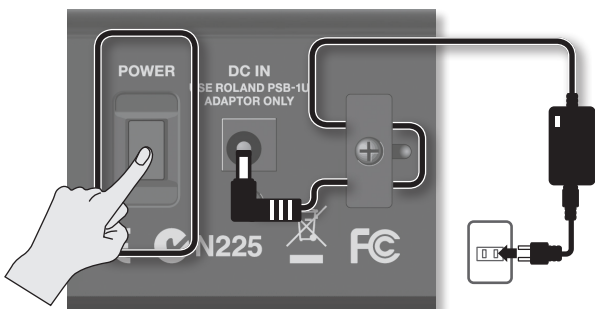

* With the factory settings, the GT-100 will automatically be switched off 10 hours after you stop playing or operating the unit. If you don't want the unit to turn off automatically, change the "AUTO OFF" setting to "OFF" as described on p. 42.

Note

The settings you were editing will be lost when the unit is turned off. If you want to keep your settings, you must save your settings before turning the unit off.

3

Adjust the volume

Use  to adjust the volume.



Convenient tuner function

For details, see **page 24**

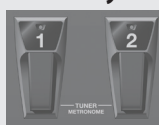
1. Press  simultaneously.
2. Play an open string, and tune it so that only the center indicator in the screen is lit.
3. When you're finished tuning, press  simultaneously once again.

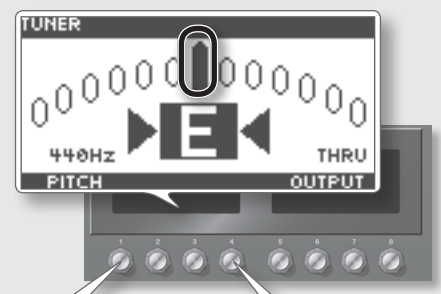

Set the reference pitch

Set the OUTPUT mode(p.24)

4 Specify the type of amp you've connected

In order to ensure optimal sound, you should specify the type of amp you've connected to the GT-100. Please take a moment to do this.

1. Press **SYSTEM**.
2. Use **4** to choose "OUTPUT SELECT".
3. Use **8** to select the type of amp you're using.
4. Press **EXIT**.

| Value | Explanation |
|---------------|---|
| JC-120 | Choose this setting if the GT-100 is connected to the guitar input of a Roland JC-120 guitar amp. |
| SMALL AMP | Choose this setting if the GT-100 is connected to a small guitar amp. |
| COMBO AMP | Choose this setting if the GT-100 is connected to the guitar input of a combo-type guitar amp (i.e., a single unit that contains the amp and speaker) other than the JC-120. For some types of guitar amps, the "JC-120" setting might produce better results. |
| STACK AMP | Choose this setting if the GT-100 is connected to the guitar input of a stack-type guitar amp (i.e., one in which the amp and speaker are separate units). |
| JC-120 RETURN | Choose this setting if the GT-100 is connected to the RETURN jack of the JC-120. |
| COMBO RETURN | Choose this setting if the GT-100 is connected to the RETURN jack of a combo-type guitar amp. |
| STACK RETURN | Choose this setting if the GT-100 is connected to the RETURN jack of a stack-type guitar amp. You should also choose the "STACK RETURN" setting if you're using a guitar power amp together with a speaker cabinet. |
| LINE/PHONES | Choose this setting if you're using headphones, or if the GT-100 is connected to a keyboard amp, mixer, or digital recorder. |

MEMO

- The SP Type parameter is valid only if the Output Select setting is set to "LINE/PHONES." For the detail on SP TYPE parameter, download "GT-100 Parameter Guide" (PDF file) from "GT-100" in the "Owner's Manuals" list on the Roland website (<http://www.roland.com/support/en/>).
- When using headphones, you won't be able to obtain a sound that is typical of a guitar amp unless you turn on a preamp. We recommend that you turn on a preamp whenever you're using headphones. For the detail on PREAMP, refer to "GT-100 Parameter Guide" (PDF file).

Now you're ready to get started! The following pages explain how to play using the GT-100.

Now that you're finished with the preparations, you can get started playing the GT-100.



What is a Patch?

The GT-100 contains numerous effects. A combination of these effects and their settings is called a "patch."

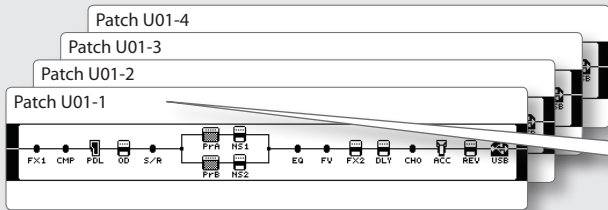

A "patch" is a combination of effects and their settings.

The GT-100 comes with 400 patches; they are organized by bank and number, as follows.

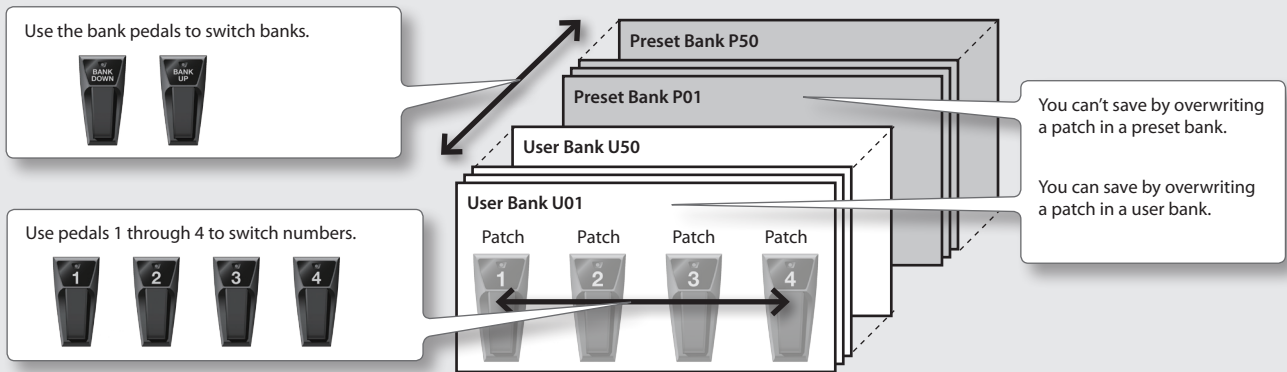

Selecting patches in the same bank

Press the pedal of the desired number.



Selecting patches from a different bank

- Use  to select the bank.
- Press the pedal of the desired number.



MEMO

You can't switch patches unless you're in the Play screen (p. 11). Press the [EXIT] button to return to the Play screen, and then switch patches.

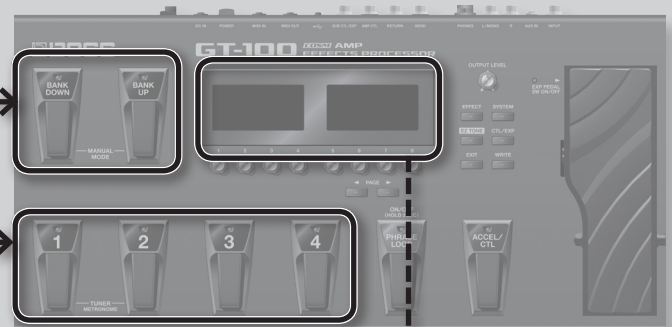

Bank and number indication

The display shows the currently selected bank and number.



You can also switch patches by turning knob [1].

Using the pedals to control the effects

When you depress the [ACCEL/CTL] pedal, it will function as either an ACCEL pedal, which allows you to modify the sound by means of an Accel effect (p. 19), or an ordinary CTL (control) pedal. The [EXP] pedal can be used to control Foot Volume, Wah, etc. The function of each of these pedals can be assigned individually for each patch.

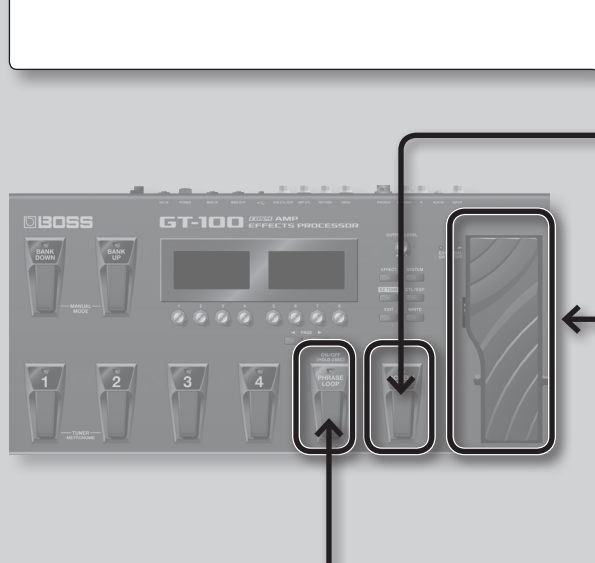

Press the [ACCEL/CTL] pedal

When using the pedal for ACCEL (SOURCE MODE set to MOMENT; p. 33), the function will be turned on when you depress the pedal (indicator will light). It will turn off when you release the pedal (the indicator will go out).

Depress the [EXP] pedal (press down on the toe)

The [EXP] pedal's value will increase.

Release the pedal (press down on the heel)

The [EXP] pedal's value will decrease.

Firmly press down on the toe

The EXP PEDAL SW function will turn on (the indicator will be lit). Firmly press down once again to turn the function off (the indicator will go out).



You are free to assign the parameters that will be controlled by these pedals.

Phrase Loop



By operating the [PHRASE LOOP] pedal you can create performances in which you build up layers of sound by recording and playing back in real time.

Page 18

page 33



Switching the Play screen

The screen that appears when you turn on the GT-100's power is called the "Play screen." There are three different Play screens, as shown below. To switch from one to the next, press the [PAGE] button.

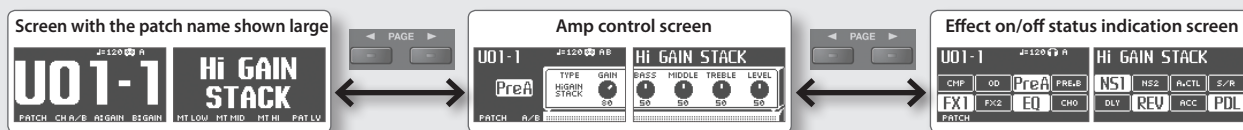

What the eight knobs do

The eight knobs located below the displays control the functions shown at the bottom of the displays.



You can assign the Play screen knobs to control the parameters you want.

page 35

The functions assigned to each knob are displayed here.

| Knob | Function | Explanation |
|------|----------|--|
| [1] | PATCH | Selects patches. |
| [2] | CH A/B | Switches between channels (settings) A and B. |
| [3] | A:GAIN | Adjusts the distortion of preamp A. |
| [4] | B:GAIN | Adjusts the distortion of preamp B. |
| [5] | MT LOW | Adjusts the low, mid, and high-frequency ranges. |
| [6] | MT MID | |
| [7] | MT HI | |
| [8] | PAT LV | Adjusts the volume. |

3 Editing: Basic Operation

Editing on the GT-100 is extremely simple; the procedure is always the same. Please take a moment to learn the basic operations.

1 Choose what you're going to edit

Press one of the following buttons.

Effect

Here you can edit the parameters of each effect. **page 16**

EZ (Easy) Tone

Here you can create the desired tone simply by choosing a musical style and the type of song you have in mind. You can also customize the amp and overdrive/distortion settings in an intuitive way. **page 14**

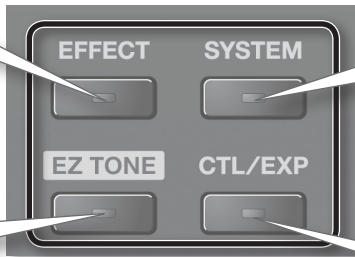

System

Here you can make settings that apply to the entire GT-100, such as output settings and phrase loop settings. **page 40**

Control/Expression

Here you can assign the desired functions to the [ACCEL/CTL] pedal, [EXP] pedal, and external pedals. **page 33**

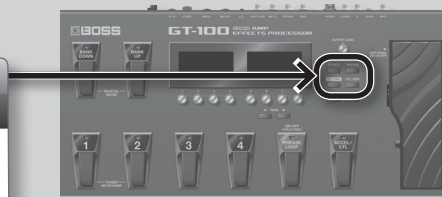

2 Select an item

Use  to select an item shown in the left display.

The screen shown here is an example of when you've pressed the [EFFECT] button.

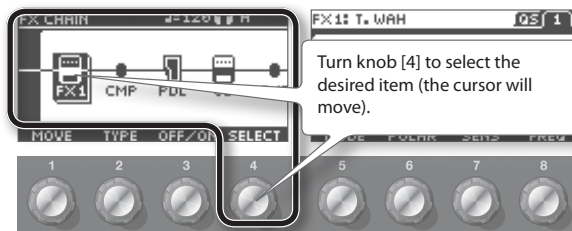

3 Edit the values

Use  to edit the values shown in the right display.

If page tabs are shown in the screen, you can use the [PAGE] buttons to move between tabs.

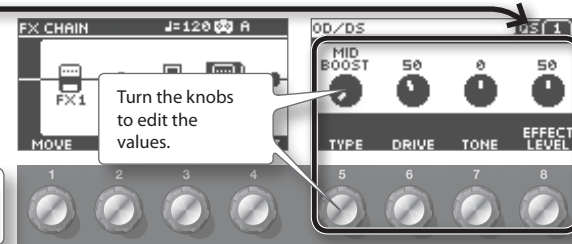

4 Exit the settings

Press .

You'll be returned to the Play screen.

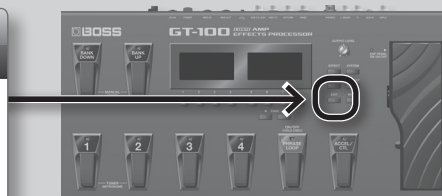

NOTE

The settings you've edited will be lost when you switch patches. If you want to keep the edited settings, you must save them as a user patch.

Next Page

Editing: Saving a Patch

If you want to keep a patch you've edited, you must save (write) it as a user patch using the procedure described below. If you don't save an edited patch, your edits will be lost when you switch patches.

1 Access the Write menu

Press .

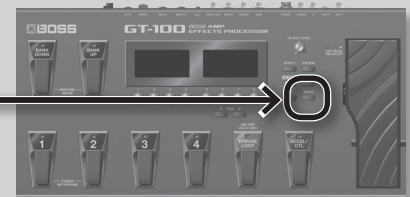

2 Select the write destination

Use  to select the write destination (U01-1-U50-4).

Assigning a name

To edit the patch name, use knob [8] to move the cursor and use knob [8] to change the character.

| Controller | Operation |
|-------------------|---|
| Knob [6] | Selects the type of characters |
| Knob [7] | Switches between lowercase/uppercase characters |
| Knob [8] | Changes the character |
| PAGE [◀ ▶] button | Moves the cursor |
| [EZ TONE] button | Deletes one character |
| [CTL/EXP] button | Inserts one character |

3 Save

Press .

When the patch has been saved, you will return to the Play screen.



Types of saving

In the left display, you can choose the type of data that will be saved. (By default, the patch will be saved.)

And if you turn knob [4]...

Exchange or copy PREAMP settings between channels A and B.

4 Editing: EZ (Easy) Tone

EZ (Easy) Tone lets you create your sound intuitively, simply by turning knobs as indicated in the screen. If you want to edit the parameters of each effect in the patch, refer to "Editing: Editing the Effects" (p. 16).

1 Enter EZ (Easy) Tone mode

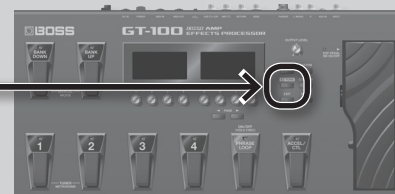

2 Select the type of editing

Use to select the type of editing

| Menu | Explanation |
|--------------|--|
| PATCH CREATE | Lets you easily create your sound starting from your choice of musical style and type of song. |
| AMP CUSTOM | Lets you intuitively customize the amp. |
| OD/DS CUSTOM | Lets you intuitively customize the overdrive/distortion. |

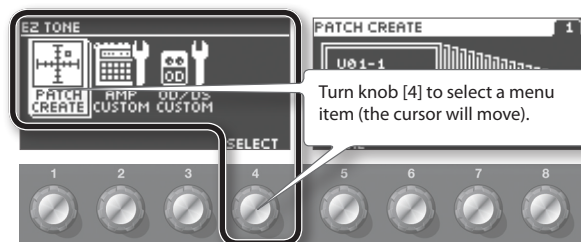

For PATCH CREATE

3 Select a musical style

Use to choose the basic tone,
and to select a variation.



| Basic tone | Explanation |
|----------------|---|
| BLUES | Blues sound |
| Soul Funk | Soul and Funk sound |
| Jazz | Jazz sound |
| LIVERPOOL | British Rock |
| 70's Hard Rock | The Hard Rock sound popular in the '70s |

| Basic tone | Explanation |
|--------------|-------------------------------------|
| 80s METAL | The Metal sound popular in the '80s |
| MODERN METAL | Modern Metal sound |
| West Coast | West Coast sound |
| Fuzz Rock | Fuzz |
| STUDIO | Recording Studio |

| Basic tone | Explanation |
|-------------|---------------------|
| PROGRESSIVE | Progressive |
| SURF ROCK | Surf Rock sound |
| COUNTRY | Country |
| Acoustic | For Acoustic Guitar |
| Punk Pop | Punk Pop |

* Upon selection of a variation, as described above, the unit will be set to the appropriate preamp type (p. 52). However, if PREAMP under PREFERENCE (p. 41) is set to SYSTEM 1 through 3, the preamp type that has been set within will be retained. In such cases, there's no need to proceed to the next step, "4. Adjust the sound."

4 Adjust the sound

Use to switch screens.

Use to adjust the sound.

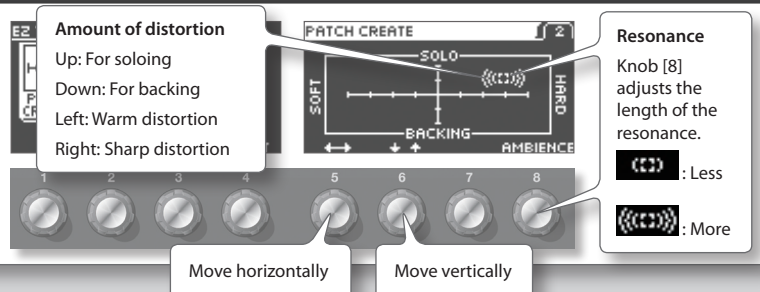

For AMP CUSTOM or OD/DS CUSTOM

3 Choose Amp or Drive

Use  to select the type.

Initially, "CURRENT" will be displayed; then, below that the preamp type or OD/DS type (p. 52) that is set for the current patch will be displayed.

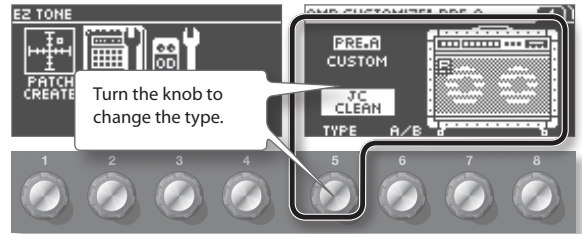

For AMP CUSTOM

| Type | Explanation |
|--------------|---|
| JC CLEAN | This models the sound of the Roland JC-120. |
| TW CLEAN | This models a Fender Twin Reverb. |
| CRUNCH | This is a crunch sound that can faithfully reproduce the nuances of picking. |
| COMBO DRIVE | This is a combo amp sound that it suited to sixties-style British rock. |
| COMBO LEAD | This is a lead sound of a combo tube amp typical of the late '70s to '80s. |
| MS HiGAIN | This models the sound input to Input I on a Marshall 1959. This is a trebly sound suited to hard rock. |
| MODERN STACK | This original high-gain amp delivers thick lows and intense distortion while still preserving the sound's clear definition. |

* In order to use AMP CUSTOM, you first need to turn on PREAMP A or B, whichever is currently selected.

For OD/DS CUSTOM

| Type | Explanation |
|--------|---|
| OD-1 | This models the sound of the BOSS OD-1. |
| OD-2 | This is an overdrive sound with high gain. |
| CRUNCH | This is a crunch sound. |
| DS-1 | This gives a basic, traditional distortion sound. |
| DS-2 | This creates a heavier distortion sound. |
| METAL1 | This is a metal sound with a characteristic midrange. |
| METAL2 | This gives a heavy metal sound. |
| FUZZ | This gives a basic, traditional fuzz sound. |

* In order to use OD/DS CUSTOM, you first need to turn on OD/DS.

4 Adjust the amount of distortion

Use  to switch screens.

Use  to adjust the distortion.

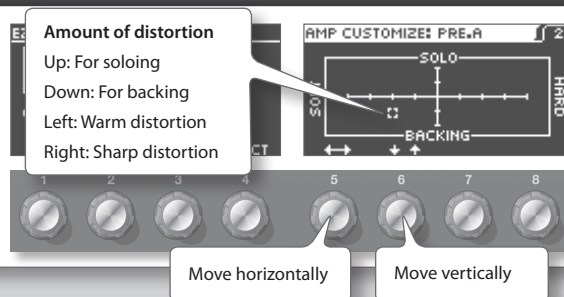

5 Finish editing

Press .

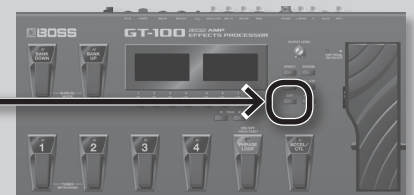

The edits you made here will be lost if you switch patches. If you want to keep the patch you created, press the [WRITE] button to save your edits as a user patch. **page 13**

5

Editing: Editing the Effects

You can edit the parameters of each effect in the patch. Here we'll show an example of editing the distortion of the overdrive effect.

1 Enter Effect Edit mode

Press .

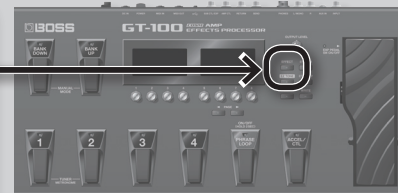

2 Select the effect that you want to edit

Use  to select OD/DS.

MEMO

An effect can also be selected by stepping on the pedal that has been set in Manual mode (p. 17).

Use knob [1] to move the position of the effect to left or right.

(Only if the cursor is located at FX1 or FX2) Use knob [2] to select the effect type for FX1 or FX2.

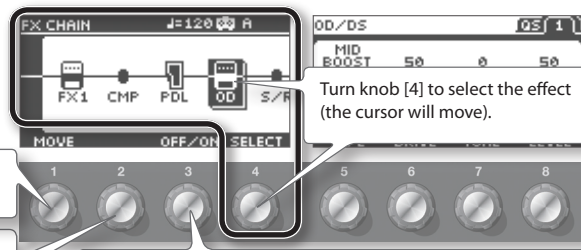

You can use knob [3] to turn the effect on/off.

3 Edit the values

Use  to edit the values shown in the right display.

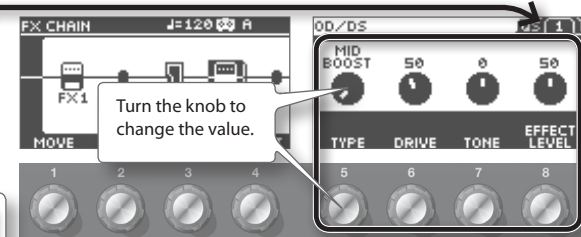

Use the [PAGE] buttons to move between page tabs.

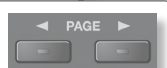

Convenient Quick Settings

If you select a page tab that shows "QS," you'll be able to easily call up settings (Quick Settings) that have been saved for each effect. For details on how to save Quick Settings, refer to "Storing Settings by Effect (Quick Setting Write)" (p. 31).

What does each knob do?

The function (parameter) of each knob will differ depending on the effect. For a list of all parameters, download "GT-100 Parameter Guide" (PDF file) from "GT-100" in the "Owner's Manuals" list on the Roland website (<http://www.roland.com/support/en/>).

Switches the type of overdrive/distortion

| Knob | Operation | Explanation |
|------|--------------|--|
| [5] | TYPE | Switches the type of overdrive/distortion. |
| [6] | DRIVE | Adjusts the amount of overdrive/distortion. |
| [7] | STONE | Adjust the tone quality. Higher values produce a sharper tone. |
| [8] | EFFECT LEVEL | Adjusts the volume when the effect is being applied. |

4 Finish editing

Press .

You'll be returned to the Play screen.

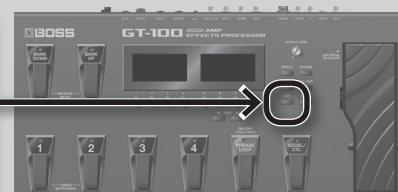

6

Advanced: Manual Mode

This section explains more advanced uses of the GT-100.



What Is Manual Mode?

Manual mode lets you use the GT-100's pedals to turn on/off individual effects within a patch.

You can use this just as though you were individually switching on/off several compact effects units in a pedalboard.



Using the pedals to turn each effect on/off (Manual mode)

1. Press  simultaneously.

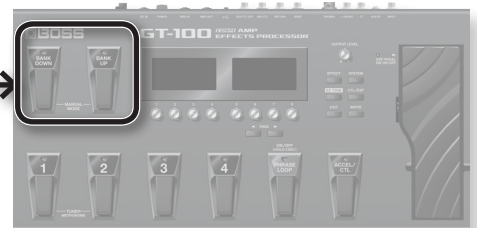

2. Use the pedals to turn each effect on/off.

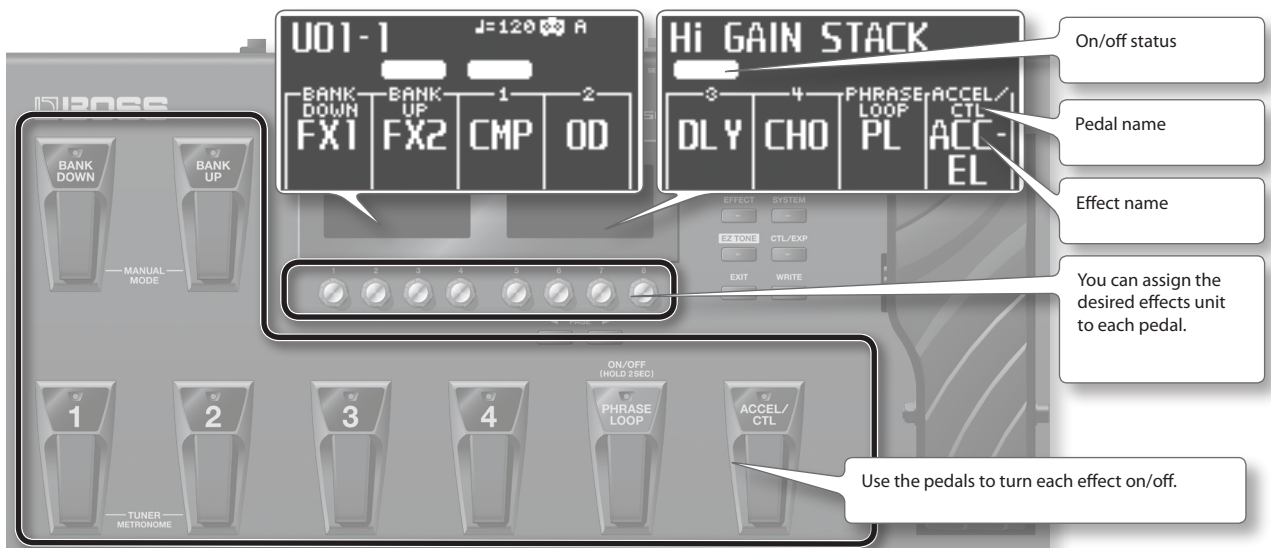

3. To exit Manual mode, press  simultaneously once again.

* If PHRASE LOOP PEDAL FUNC (p. 32) is set to "PHRASE LOOP," you won't be able to assign anything other than PHRASE LOOP ("PL") to the [PHRASE LOOP] pedal. If you want to assign any other function, you must turn PHRASE LOOP PEDAL FUNC off.



Advanced: Phrase Loop

By operating the [PHRASE LOOP] pedal, you can carry out recording and playback in real time to create layered performances.

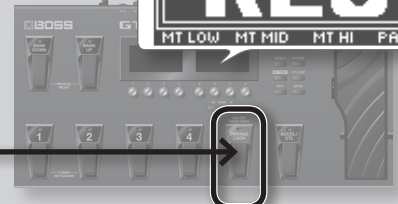
Each time you press the pedal, the right display will show the phrase loop status for a predetermined amount of time.



Enter Phrase Loop mode

Hold down the pedal for two seconds or longer; the Phrase Loop function will turn on, and will be in the standby condition.

Record



Press the pedal once again, and record your guitar performance.

Loop playback



Play back the loop.

Pressing the pedal will switch to overdubbing.



Overdub





Record additional layers while playing back the loop.

Press the pedal to switch to playback.

Press twice



Clear/Exit



To clear the phrase and exit Phrase Loop, hold down the pedal for at least two seconds while stopped.

- * The recorded content will be erased when you exit Phrase Loop.
- * The recorded content will not be saved.



Hold down two seconds or longer

Stop



To stop, press the pedal twice in succession during overdubbing or loop playback.

- * Press the pedal twice within one second.



About Phrase Loop

The recording time is 38 seconds in monaural.
To make settings for Phrase Loop, see "Setting Phrase Loop" (p. 32).

About the pedal's indicator

The pedal's indicator will blink or light in a different pattern according to the Phrase Loop status.

| Status | Indicator illumination pattern |
|-------------------|--------------------------------|
| Standby | ☀ ☀ ● ☀ ☀ ● ... |
| Recording/Overdub | ☀ ● ☀ ● ☀ ● ... |
| Playback | ☀ (stays lit) |



Indicator

☀ : lit ● : unlit

8 Advanced: Accel Effect

The GT-100 has six different Accel effects that make the sound more aggressive when you press the [ACCEL/CTL] pedal. First, you need to set [CTL/EXP]: ACCEL/CTL FUNC to ACCEL, and set SOURCE MODE to MOMENT (p. 33).

1 Enter Effect Edit mode

Press .

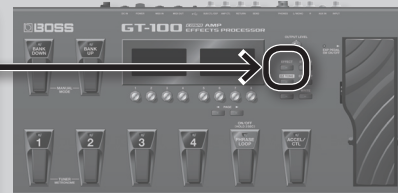

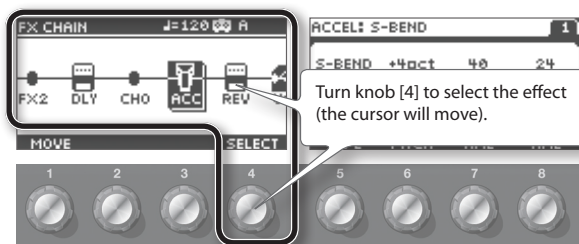

2 Select the ACCEL effect

Use  to select "ACCEL."



3 Select the effect

Use  to select the type of ACCEL effect.
Use  to adjust the sound.

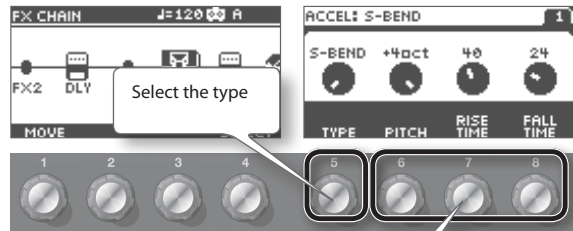

ACCEL effects types

| Type | Effect |
|----------------|--|
| S-BEND | Applies intense bending. |
| LASER BEAM | Produces a laser beam-like sound. |
| RING MODULATOR | Produces a metallic sound, creating the impression that the sound is being focused. |
| TWIST | Produces an aggressive sense of rotation. Using this in conjunction with distortion will produce an even wilder sense of rotation. |
| WARP | Produces a dream-like sound. |
| FEEDBACKER | Generates feedback performance. |

4 Exit the settings

Press .
You'll be returned to the Play screen.

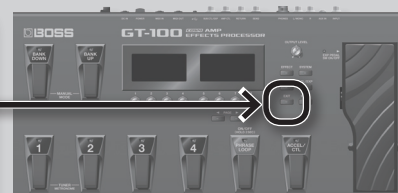

Panel Descriptions

Front Panel

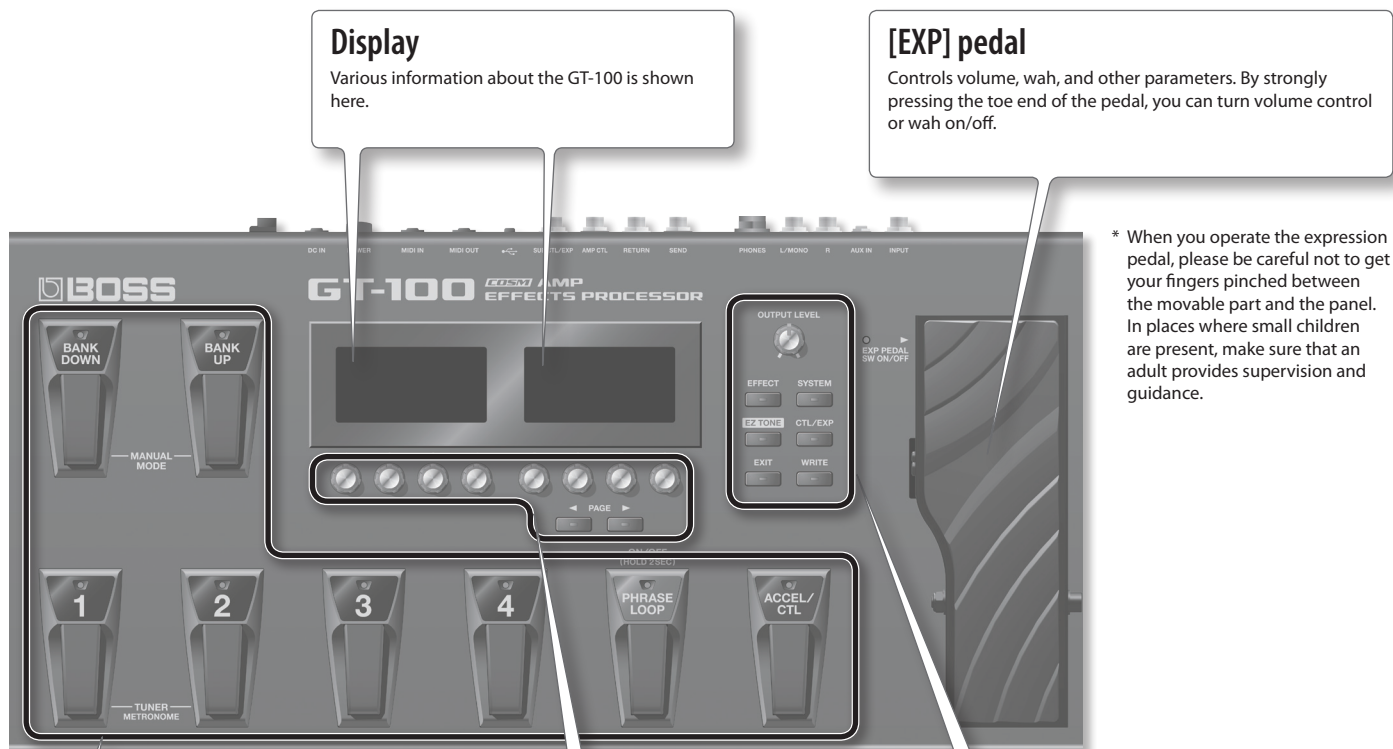

Display

Various information about the GT-100 is shown here.

[EXP] pedal

Controls volume, wah, and other parameters. By strongly pressing the toe end of the pedal, you can turn volume control or wah on/off.

* When you operate the expression pedal, please be careful not to get your fingers pinched between the movable part and the panel. In places where small children are present, make sure that an adult provides supervision and guidance.

| Pedal | Explanation |
|-------------------|---|
| [BANK UP] | Switch the patch bank (p. 10) or turn Manual mode on/off (p. 17). |
| [BANK DOWN] | |
| Number pedals 1-4 | These switch the patch number (p. 10). Press the [1]/[2] pedals simultaneously to turn the tuner function on/off (p. 24). |
| [PHRASE LOOP] | Starts the Phrase Loop function (p. 18). |
| [ACCEL/CTL] pedal | Starts the Accel function (p. 19), or can be used as a control pedal. |

| Knob/Button | Explanation |
|-------------------------|---|
| Parameter knobs [1]-[8] | Adjust the parameter values shown in the display. |
| PAGE [◀][▶] button | Switch pages in the display. |

| Knob/Button | Explanation |
|---------------------|--|
| [OUTPUT LEVEL] knob | This adjusts the volume level at the OUTPUT jack and the PHONES jack. |
| [EFFECT] button | Lets you make effect settings (p. 16). |
| [SYSTEM] button | Lets you make overall settings for the entire GT-100 (p. 40). |
| [EZ TONE] button | Lets you easily create a sound by specifying a musical style or character of song (p. 14). |
| [CTL/EXP] button | Lets you make control pedal and expression pedal assignments (p. 33). |
| [EXIT] button | Returns you to the previous screen, or cancels the previous operation. |
| [WRITE] button | Saves patch settings, or lets you exchange or copy data (p. 30). |

About the Play Screen

The screen that appears after you turn on the power is called the Play screen.

Icons in the display

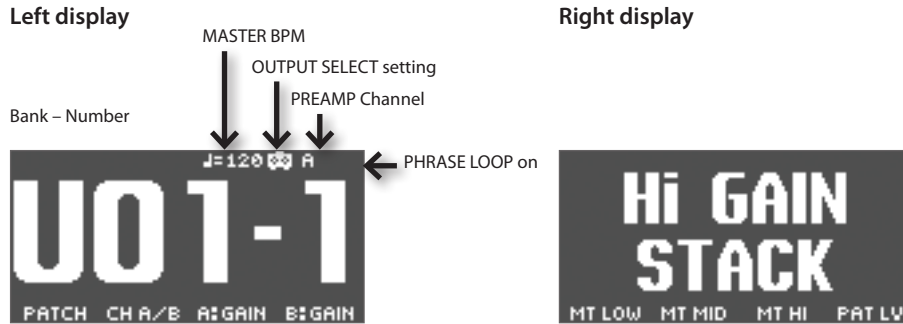

| Icon | Explanation |
|--------------------|--|
| J=120 | Displays the Master BPM (*1) value for each patch. |
| [Loop Icon] | This is displayed when OUTPUT SELECT (p. 9) is set to anything other than LINE/PHONES. |
| [Line/Phones Icon] | This is displayed when OUTPUT SELECT (p. 9) is set to LINE/PHONES. |
| A | When the DIVIDER (p. 27) mode is Single, preamp channel "A" is selected. |
| B | When the DIVIDER (p. 27) mode is Single, preamp channel "B" is selected. |
| AB | This is displayed if the DIVIDER (p. 27) mode is Dual. |
| [Solo Icon] | This icon is highlighted if the SOLO SW (*1) is on. |
| [Phrase Loop Icon] | This is displayed when the PHRASE LOOP (p. 18) is On. |

*1 For the detail on the Master BPM and SOLO SW, download "GT-100 Parameter Guide" (PDF file) from "GT-100" in the "Owner's Manuals" list on the Roland website (<http://www.roland.com/support/en/>).

Types of Play screens



Use the PAGE [◀] [▶] buttons to switch.

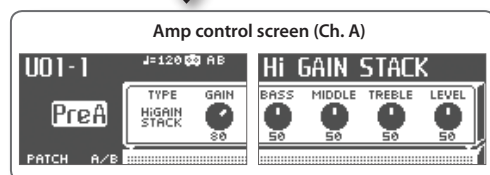

Use the PAGE [◀] [▶] buttons to switch.

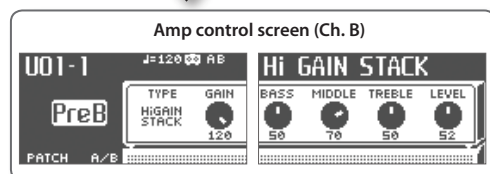

Use the PAGE [◀] [▶] buttons to switch.

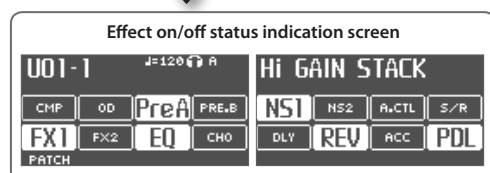

If DIVIDER (p. 27) is set to SINGLE, only the screen of the currently selected channel (not both channels) will be shown.

The explanations in this manual include illustrations that depict what should typically be shown by the display. Note, however, that your unit may incorporate a newer, enhanced version of the system (e.g., includes newer sounds), so what you actually see in the display may not always match what appears in the manual.

Quick Guide
Overview
Outputting Sound
Effects
Saving
Pedal Settings
System
MIDI/USB
Appendices

Rear Panel (Connections)

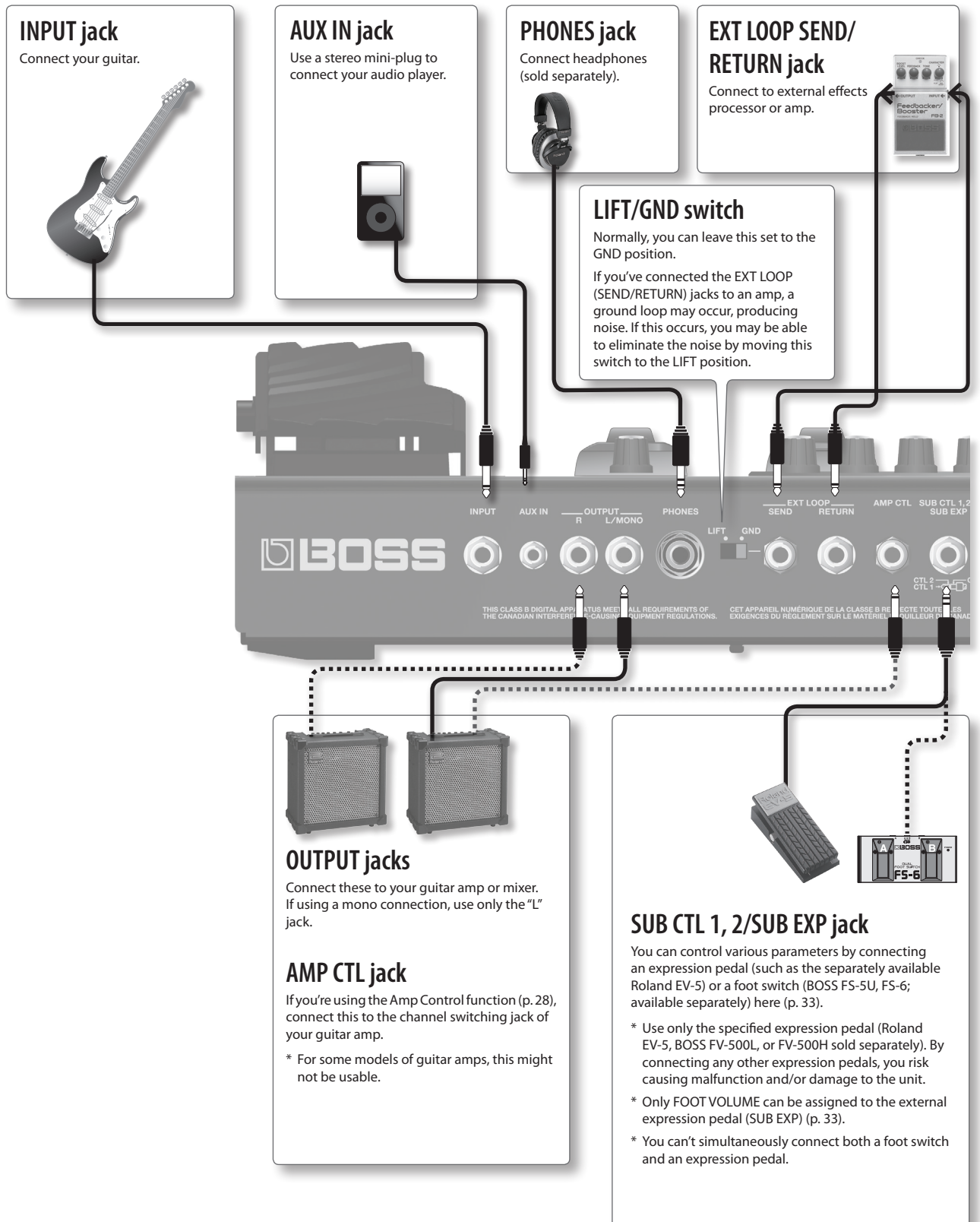

* To prevent malfunction and equipment failure, always turn down the volume, and turn off all the units before making any connections.

* When connection cables with resistors are used, the volume level of equipment connected to the inputs (INPUT, AUX IN, RETURN jacks) may be low. If this happens, use connection cables that do not contain resistors.

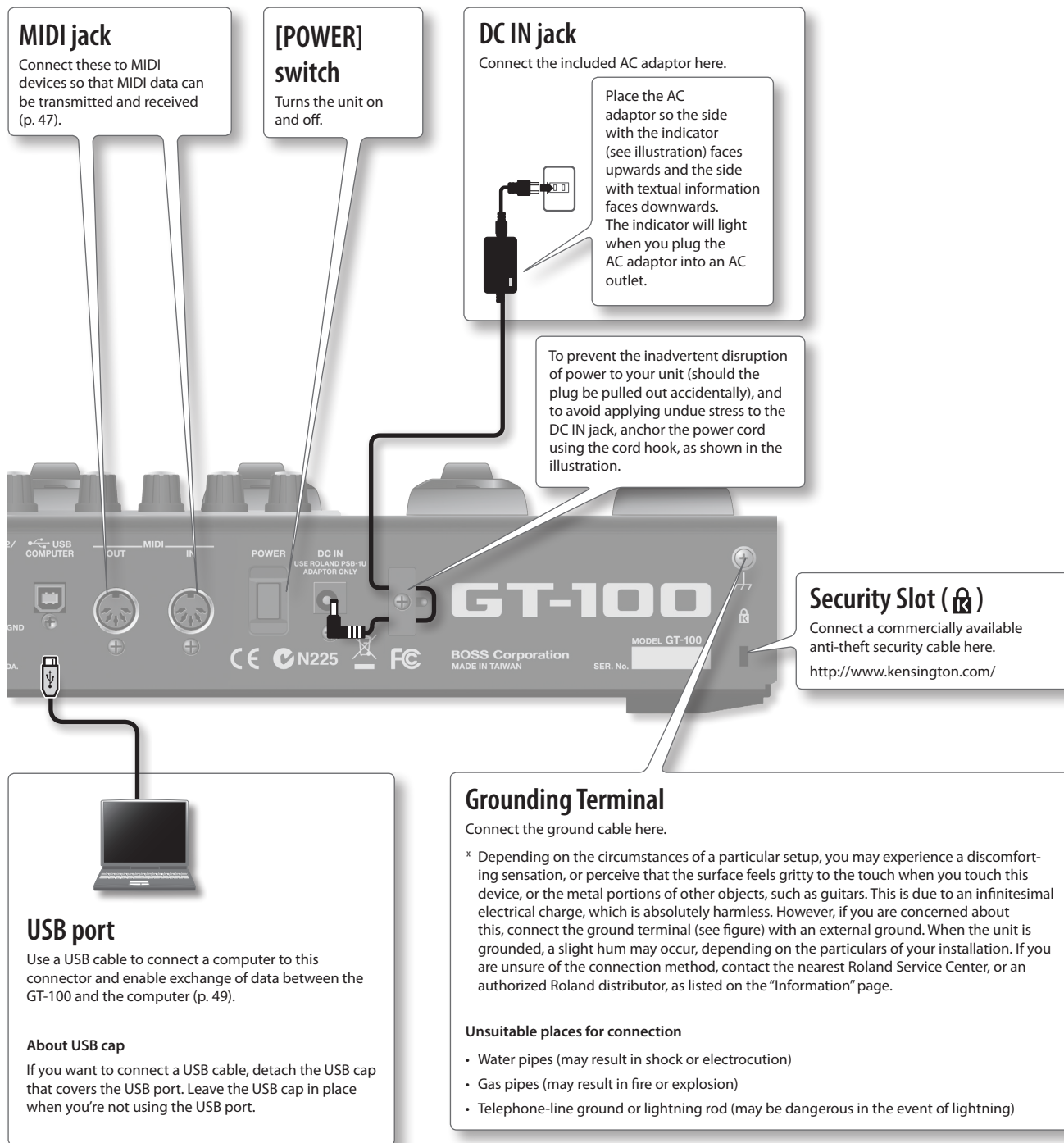

MIDI jack
Connect these to MIDI devices so that MIDI data can be transmitted and received (p. 47).

[POWER] switch
Turns the unit on and off.

DC IN jack
Connect the included AC adaptor here.
Place the AC adaptor so the side with the indicator (see illustration) faces upwards and the side with textual information faces downwards. The indicator will light when you plug the AC adaptor into an AC outlet.

To prevent the inadvertent disruption of power to your unit (should the plug be pulled out accidentally), and to avoid applying undue stress to the DC IN jack, anchor the power cord using the cord hook, as shown in the illustration.

Security Slot (🔒)
Connect a commercially available anti-theft security cable here.
<http://www.kensington.com/>

USB port
Use a USB cable to connect a computer to this connector and enable exchange of data between the GT-100 and the computer (p. 49).
About USB cap
If you want to connect a USB cable, detach the USB cap that covers the USB port. Leave the USB cap in place when you're not using the USB port.

Grounding Terminal
Connect the ground cable here.
* Depending on the circumstances of a particular setup, you may experience a discomforting sensation, or perceive that the surface feels gritty to the touch when you touch this device, or the metal portions of other objects, such as guitars. This is due to an infinitesimal electrical charge, which is absolutely harmless. However, if you are concerned about this, connect the ground terminal (see figure) with an external ground. When the unit is grounded, a slight hum may occur, depending on the particulars of your installation. If you are unsure of the connection method, contact the nearest Roland Service Center, or an authorized Roland distributor, as listed on the "Information" page.
Unsuitable places for connection

- Water pipes (may result in shock or electrocution)
- Gas pipes (may result in fire or explosion)
- Telephone-line ground or lightning rod (may be dangerous in the event of lightning)

Outputting Sounds

Switching the Unit On and Off

Switching the Unit On

- * Once everything is properly connected (p. 22), be sure to follow the procedure below to turn on their power. If you turn on equipment in the wrong order, you risk causing malfunction or equipment failure.
- * Before turning the unit on/off, always be sure to turn the volume down. Even with the volume turned down, you might hear some sound when switching the unit on/off. However, this is normal and does not indicate a malfunction.
- * This unit is equipped with a protection circuit. A brief interval (a few seconds) after turning the unit on is required before it will operate normally.

1. Press the GT-100's [POWER] switch to turn on the power.



2. Turn on the power of the connected guitar amp.

Switching the Unit Off

1. Before turning off the power, confirm the following.
 - Have you minimized the volume of the connected equipment?
 - Have you saved any patches containing settings that have been changed? "Saving a Patch (PATCH WRITE)" (p. 30)
2. Turn off the power of your guitar amp and any other connected equipment.
3. Hold down the GT-100's [POWER] switch for several seconds to turn off the power.

Adjusting the Output Level

1. Adjust the GT-100's output level with the [OUTPUT LEVEL] knob.



Specifying the Output Device (Output Select)

You'll need to specify the type of device (amp) that's connected to the OUTPUT jacks. The GT-100 will apply an internal adjustment so that the output will sound optimal on the system you're using.

Reference

For details on how to make this setting, refer to "Specify the type of amp you've connected" (p. 9)

Tuning the Guitar (TUNER)

1. Simultaneously press pedals [1] and [2].

The tuner function and the metronome function will turn on. The left display will show the "TUNER" screen.



2. Turn knob [1] to specify the reference pitch.
3. Turn knob [4] to specify how the guitar sound will be output while you're using the tuner.

| Parameter | Value | Explanation |
|------------|---------------|---|
| [1] PITCH | 435 Hz–445 Hz | Specifies the reference pitch. |
| [4] OUTPUT | MUTE | Sound will not be output while tuning. |
| | BYPASS | While tuning, the sound of the guitar being input to the GT-100 will be output without change. All effects will be off. |
| | THRU | Allows you to tune while hearing the current effect sound. |

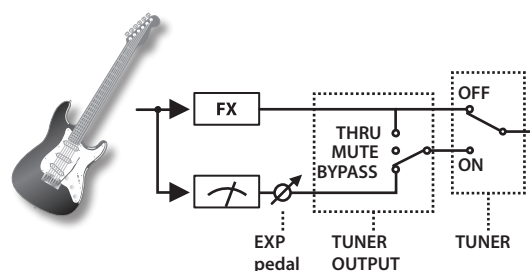

4. Play an unfretted note on the string that you want to tune, and tune the string until the desired note name is shown in the display.
5. While watching the screen, tune the string until only the middle indicator is lit.

Repeat steps 4–5 to tune all strings.

MEMO

If you're tuning a guitar that's equipped with a tremolo arm, tuning one string may cause other strings to drift. If so, start by tuning the strings approximately, so that the correct note names are displayed; then repeatedly tune each string until all strings are in tune.

6. Simultaneously press pedals [1] and [2] to return to the Play screen.

You can also return to the Play screen by pressing the [EXIT] button.

MEMO

You can also turn the tuner on/off by pressing the number pedal of the same number as the currently selected patch. For details, refer to "Adjusting the [EXP] pedal" (p. 36) "Switching Settings with the Number Pedals" (p. 35).

Using the Metronome

1. Simultaneously press pedals [1] and [2].

The tuner function and the metronome function will turn on. The right display will show the "METRONOME" screen.

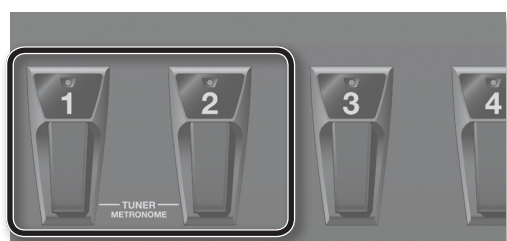

2. Use knobs [5]–[8] to specify the metronome settings.

| Parameter | Value | Explanation |
|------------|---|---------------------------------------|
| [5] TEMPO | 40–250 | Specifies the tempo of the metronome. |
| [6] BEAT | 1/1–8/1, 1/2–8/2, 1/4–8/4, 1/8–8/8 | Selects the time signature. |
| [7] OFF/ON | OFF, ON | Turns the metronome on/off. |
| [8] LEVEL | 0–100 | Adjusts the volume of the metronome. |

* The metronome sound is output through the OUTPUT jack and the PHONES jack.

* Changing the TEMPO will also change the MASTER BPM. For the detail on MASTER BPM, refer to "GT-100 Parameter Guide" (PDF file).

3. Simultaneously press pedals [1] and [2] to return to the Play screen.

You can also return to the Play screen by pressing the [EXIT] button.

Selecting a Tone (Patch Change)

A combination (or set) of effects together with a group of parameter settings is called a "patch."

How a Patch Is Structured

The GT-100 can store 400 different patches in memory, organized by bank and number as shown below.

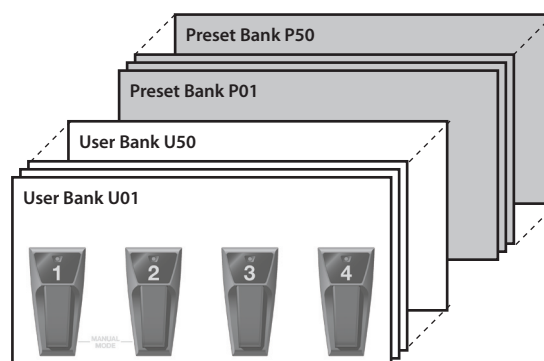

User Banks (U01–U50)

Newly created effects settings are saved in the User banks. Patches in these banks are called "User patches."

A "U" appears in the display when a User patch is selected.



Preset Banks (P01–P50)

The Preset banks contain effect settings that make full use of the features the GT-100 has to offer. The patches in these banks are called "Preset patches." When you change the settings of a Preset patch, save the result as a User patch. Preset patches cannot be overwritten.

A "P" appears in the display when a Preset patch is selected.



Using the Pedal to Select the Patch

Patches are switched by selecting a “bank” (U01–U50, P01–P50) and “number” (1–4).

* On the GT-100, you cannot switch patches in any screen other than the Play screen. Press [EXIT] to return to the Play screen (p. 21).

1. Select a bank.

Use the [BANK UP]/[BANK DOWN] pedals to select a bank.

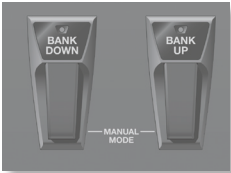

2. Select a patch within the selected bank.

Use pedals [1]–[4] to select a patch within the bank you selected in step 1.

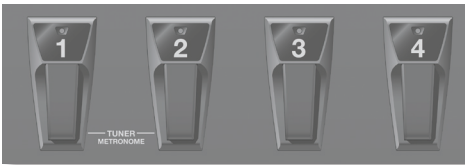

MEMO

When selecting a patch, even if a new bank is selected, the patch is not switched until you also choose the number. If you want to be able to switch patches merely by selecting a different bank, adjust the BANK CHG MODE (p. 41) setting.

Using the Knobs to Select a Patch

You can also use knob [1] to select a patch.



* You can change the function of the knobs (p. 41).

Creating Sounds (Effects)

Setting the Effects

Use the left and right displays and knobs [1]–[8] to edit the settings of the internal effects.

Reference

For details on the basic procedures for manipulating effects, refer to “Editing: Editing the Effects” (p. 16).

Specifying the Divider and Mixer Modes

Within the effect chain, the point where the signal is split into channels “A” and “B” is called the “divider,” and the point where the two signals are recombined is called the “mixer.”

You can use the divider to switch between channels “A” and “B,” to assign strongly picked notes and softly picked notes to different channels, or to assign different frequency bands of your guitar sound to different channels.

The mixer lets you adjust the volume balance of channels “A” and “B,” place them in the stereo field, or slightly delay the sound of channel “B” to produce a spacious sound.

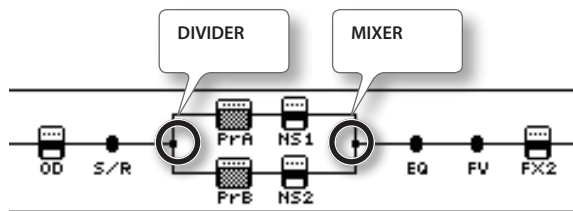

Divider settings

1. Press the [EFFECT] button.
2. Use knob [4] to select “DIVIDER.”
3. Use knobs [5]–[8] and the PAGE [◀][▶] buttons to make settings.

| Con-troller | Parameter | Value | Explanation |
|-------------|-----------|--------|--|
| Page 1 | | | |
| [5] | MODE | SINGLE | Use only one channel, either “A” or “B.” |
| | | DUAL | Use the two channels “A” and “B.” |

Single mode settings

If you selected “SINGLE” with knob [5]

| Con-troller | Parameter | Value | Explanation |
|-------------|-----------|--------------|-----------------------------|
| Page 1 | | | |
| [6] | CH SELECT | CH. A, CH. B | Selects the channel to use. |

Dual mode settings

If you selected “DUAL” with knob [5]

| Con-troller | Parameter | Value | Explanation |
|-------------|--------------------|--------------|---|
| Page 2 | | | |
| [5] | CH. A DYNAMIC | OFF | DYNAMIC will not be used. |
| | | POLAR+ | Only notes picked more strongly than the DYNAMIC SENS setting will be output. |
| | | POLAR- | Only notes picked more softly than the DYNAMIC SENS setting will be output. |
| [6] | CH. A DYNAMIC SENS | 0–100 | Specifies the picking sensitivity. |
| [7] | CH. A FILTER | OFF | The filter will not be used. |
| | | LPF | Only the region below the cutoff frequency will be output. |
| | | HPF | Only the region above the cutoff frequency will be output. |
| [8] | CH. A CUTOFF FREQ | 100 Hz–2 kHz | Cutoff frequency |
| Page 3 | | | |
| [5] | CH. B DYNAMIC | OFF | DYNAMIC will not be used. |
| | | POLAR+ | Only notes picked more strongly than the DYNAMIC SENS setting will be output. |
| | | POLAR- | Only notes picked more softly than the DYNAMIC SENS setting will be output. |
| [6] | CH. B DYNAMIC SENS | 0–100 | Specifies the picking sensitivity. |
| [7] | CH. B FILTER | OFF | The filter will not be used. |
| | | LPF | Only the region below the cutoff frequency will be output. |
| | | HPF | Only the region above the cutoff frequency will be output. |
| [8] | CH. B CUTOFF FREQ | 100 Hz–2 kHz | Cutoff frequency |

Mixer settings

1. Press the [EFFECT] button.
2. Use knob [4] to select "MIXER."
3. Use knobs [5]–[7] to make settings.

| Con-troller | Parameter | Value | Explanation |
|-------------|---------------|-------------|---|
| [5] | MODE | STEREO | Channels "A" and "B" will be mixed and output in stereo. |
| | | L/R PAN | Channels "A" and "B" will be assigned respectively to the L and R OUTPUT jacks. |
| [6] | CH A/B BALANC | 100:0–0:100 | Adjusts the volume balance of channels "A" and "B." * This is shown only if DIVIDER MODE is set to "DUAL." |
| [7] | SPREAD | 0–100 | Slightly delays the sound of channel "B" to make the sound more spacious. * This is shown only if DIVIDER MODE is set to "DUAL." |

Using Amp Control

By connecting your guitar amp's channel switching jack to the GT-100's AMP CONTROL jack, you can then use Amp Control to switch the amp channel.

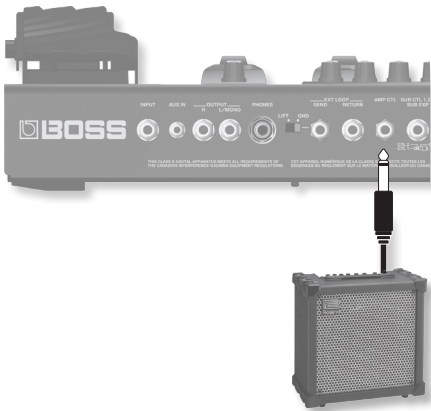

This combining of the GT-100 and the amp channels allows you to get an even wider variety of distortion sounds. Since the Amp Control setting is handled as one of the effects parameters saved to each individual patch, it allows you to switch guitar amp channels with each patch.

1. Press the [EFFECT] button.
2. Use knob [4] to select "MASTER SETTING".
3. Press the PAGE [▶] button to access page 4.

4. Use knob [5] to switch the setting on/off.

| Con-troller | Parameter | Value | Explanation |
|-------------|-------------|-------|-------------|
| Page 4 | | | |
| [5] | AMP CONTROL | OFF | |
| | | ON | |

* To determine how the amp channels are switched when the circuit is open and shorted, refer to the amp owner's manual, or actually confirm the sounds by operating the amp.

* Note that, depending on the circuitry of the channel switching jack in the guitar amp used, the Amp Control function may not operate.

* Since this is a single mono plug, it can't switch a three-channel amp.

MEMO

With Amp Control, not only can you switch amp channels, you can also use it to switch the amp's effects on and off, like a footswitch controller.

Using Send/Return

You can connect an external effects processor between the SEND jack and RETURN jack, and use it as one of the GT-100's effects processors.

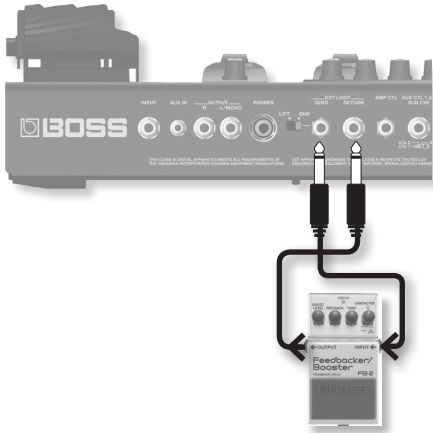

The sound that is input to SEND/RETURN within the effect chain will be output to the SEND jack. The sound that is input via the RETURN jack will be input to SEND/RETURN within the effect chain.

1. Press the [EFFECT] button.
2. Use knob [4] to select "SEND/RETURN."
3. Use knobs [5]–[8] to make settings.

| Con-troller | Parameter | Value | Explanation |
|-------------|--------------|------------|---|
| [5] | MODE | NORMAL | <p>The input to SEND/RETURN within the effect chain will be output to the SEND jack, and the input from the RETURN jack will be output following SEND/RETURN.</p> <p>Use this setting if you want to connect an external effects processor in series within the GT-100's effect chain.</p> |
| | | DIRECT MIX | <p>The input to SEND/RETURN within the effect chain will be output to the SEND jack, and the input from the RETURN jack (the direct sound) will be mixed and output following SEND/RETURN.</p> <p>Use this when you want to mix the GT-100's effects sounds together with the sound with the external effects device applied to it.</p> |
| | | BRANCH OUT | <p>The input to SEND/RETURN within the effect chain will be output to the SEND jack. The input from the RETURN jack will be ignored.</p> <p>For example, by placing SEND/RETURN in the GT-100's effect chain in front of reverb or delay, this allows you to use the SEND jack as a direct out.</p> |
| [7] | SEND LEVEL | 0–200 | Adjusts the volume of the output to the external effects device. |
| [8] | RETURN LEVEL | 0–200 | Adjusts the volume of the input from the external effects device. |

Saving a Tone

Saving a Patch (PATCH WRITE)

If you want to save the changes in the settings, carry out the Write procedure.

NOTE

The patch previously stored at the write destination will be lost once the write is executed.

1. Press the [WRITE] button.

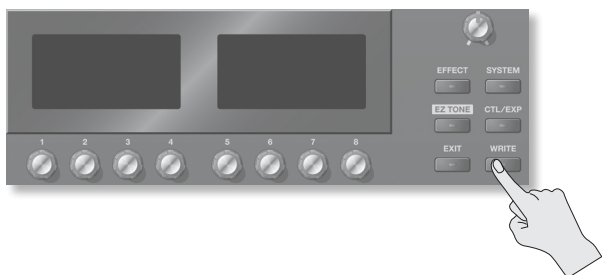

2. Turn knob [4] to select "WRITE" (PATCH WRITE),

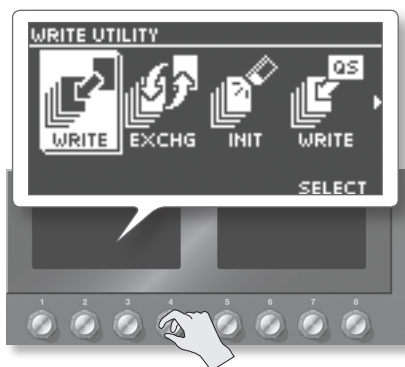

3. Turn knob [5] to select the write destination.

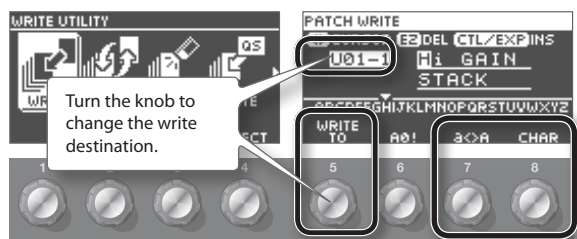

Assigning a name

To edit the patch name, use PAGE [◀▶] buttons move the cursor and use knob [8] to change the character.

| Controller | Operation |
|------------------|---|
| Knob [6] | Selects the type of characters |
| Knob [7] | Switches between lowercase/uppercase characters |
| Knob [8] | Changes the character |
| PAGE [◀▶] button | Moves the cursor |
| [EZ TONE] button | Deletes one character |
| [CTL/EXP] button | Inserts one character |

* If you decide to cancel without writing, press the [EXIT] button. You'll be returned to the Play screen.

4. Press the [WRITE] button once again.

The patch will be written.

Exchanging Patches (PATCH EXCHANGE)

On the GT-100, you can "swap" or exchange the positions of two User patches. The following explains how this is done.

1. Select the exchange source patch.
2. Press the [WRITE] button.
3. Use knob [4] to select "EXCHG" (PATCH EXCHANGE).

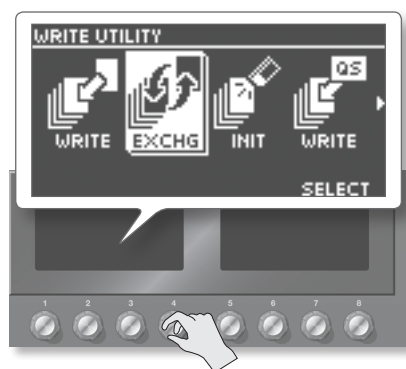

4. Turn knob [5] to select the other user patch that you want to exchange.



* If you decide to cancel without exchanging, press the [EXIT] button. You'll be returned to the Play screen.

5. Press the [WRITE] button once again.

The patches will be exchanged.

Initializing Patches (PATCH INITIALIZE)

You can return (initialize) a User patch to its original factory settings. This is convenient when you want to create a new patch from scratch.

NOTE

Any tone settings you've stored in a patch are lost once the initialization is executed.

1. Press the [WRITE] button.
2. Use knob [4] to select the "PATCH INITIALIZE" screen.

- Turn knob [5] to select the user patch that you want to initialize.

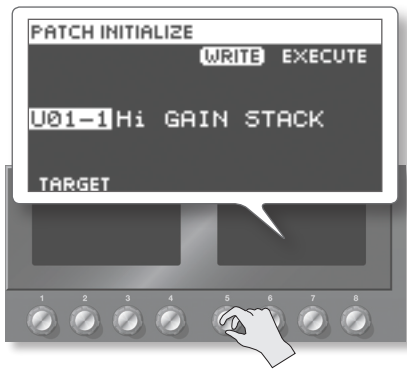

* If you decide to cancel without initializing, press the [EXIT] button. You'll be returned to the Play screen.

- Press the [WRITE] button once again. The patch will be initialized.

Storing Settings by Effect (Quick Setting Write)

In addition to storing settings in the form of patches, you can also store settings for individual effects.

Since you can use such stored settings in other patches, just like with the Preset Quick Setting, storing effects settings you like ahead of time User Quick Setting is a convenient way to create new patches.

- Press the [WRITE] button.
- Use knob [4] to select the "QUICK SETTING WRITE" screen.
- Turn knob [5] to select the effect whose settings you want to store.

| Effects that can be stored in memory |
|--------------------------------------|
| Each PREAMP channel |
| OD/DS |
| DELAY |
| CHORUS |
| REVERB |
| COMP |
| EQ |
| The PEDAL FX's WAH and PEDAL BEND |
| SEND/RETURN |
| DIVIDER |
| Each FX1/FX2 effect |
| ASSIGN 1-8 |

- Turn knob [6] to select the write destination (U01 - U10).

Assigning a name

To edit the patch name, PAGE [◀|▶] buttons to move the cursor and use knob [8] to change the character.

| Controller | Operation |
|-------------------|---|
| Knob [7] | Switches between lowercase/uppercase characters |
| Knob [8] | Changes the character |
| PAGE [◀ ▶] button | Moves the cursor |
| [EZ TONE] button | Deletes one character |
| [CTL/EXP] button | Inserts one character |

* If you decide to cancel without writing, press the [EXIT] button. You'll be returned to the Play screen.

- Press the [WRITE] button once again. The Quick Setting will be written.

Copying or Swapping PREAMP Settings Between Channels

The PREAMP settings can be copied or exchanged between channels "A" and "B."

- Press the [WRITE] button.
- Use knob [4] to select the "CH A/B UTILITY" screen.



- Use knob [5] to select the Copy or Exchange function.

| Indication | Explanation |
|--------------------|--|
| PREAMP&SP CH.A → B | Copies the channel "A" PREAMP and SPEAKER settings to channel "B." |
| PREAMP&SP CH.B → A | Copies the channel "B" PREAMP and SPEAKER settings to channel "A." |
| PREAMP&SP CH.A ↔ B | Exchanges the channel "A" PREAMP and SPEAKER settings with those of channel "B." |
| CHAIN CH.A ↔ B | Exchanges the channel "A" PREAMP and SPEAKER settings with those of channel "B," and also exchanges the position of channel "A" and channel "B." |

* If you decide to cancel without executing, press the [EXIT] button. You'll be returned to the Play screen.

- Press the [WRITE] button once again. The exchange or copy operation will be executed.

Phrase Loop Play

Phrase Loop is a recorder function that lets you record up to 38 seconds (when using monaural recording) of audio, and play it back by operating a pedal. By layering sounds as you continue real-time recording and playback, you can create a wide variety of performances.

You can record a phrase loop with effects, or you can add effects after a loop has been recorded. Adding effects after-the-fact lets you create special effects with recorded performances.

* Recorded phrases are deleted when Phrase Loop is switched off or when the power is turned off.

Reference

For more about Phrase Loop operation, refer to “Advanced: Phrase Loop” (p. 18).

Setting Phrase Loop

Phrase Loop offers a variety of modes. By changing the settings, you can use this function in various ways.

Setting procedure

1. Press the [SYSTEM] button.



2. Turn knob [4] to select “PHRASE LOOP” in the left display.

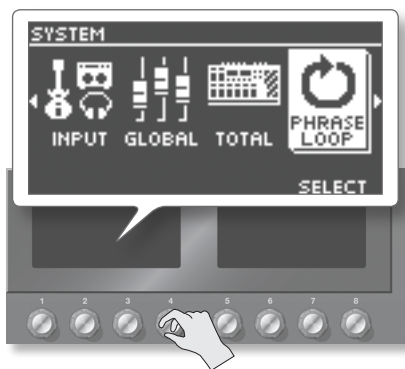

3. Use knobs [5]–[8] to select the desired settings.

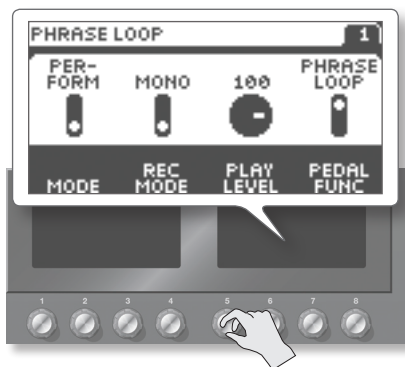

| Parameter | Value | Explanation |
|----------------|-------------|--|
| Page 1 | | |
| [5] MODE | PERFORM | The sound processed by the effects will be recorded. This lets you create a variety of performances by layering different sounds. |
| | PATCH EDIT | The sound before being processed by the effects will be recorded, and the effects will be applied when the loop is played back. This is a convenient way to adjust the effects, or to compare the sound of different patches. |
| [6] REC MODE | MONO | The phrase will be recorded in monaural (maximum 38 seconds). |
| | STEREO | The phrase will be recorded in stereo (maximum 19 seconds). |
| [7] PLAY LEVEL | 0–120 | Specifies the phrase playback volume. |
| [8] PEDAL FUNC | OFF | Phrase Loop will not operate even if you press the [PHRASE LOOP] pedal. |
| | PHRASE LOOP | You can use the [PHRASE LOOP] pedal to switch Phrase Loop on/off or to record. |

4. Press the [EXIT] button to return to the Play screen.

Pedal Settings (Control/Expression)

Connect your foot switch to the SUB CTL 1, 2/SUB EXP jack as shown in the illustration, and set its POLARITY switch.

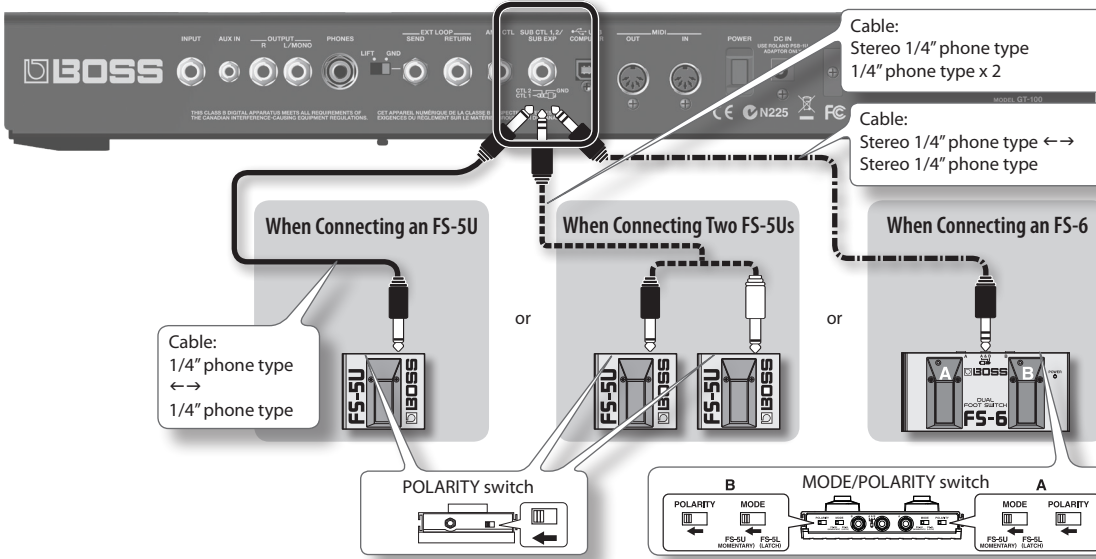

Using Pedals to Control the Parameters

Here's how to assign the parameters that will be controlled by the ACCEL/CTL, EXP, SUB EXP, SUB CTL1, and SUB CTL2 pedals. For details on each pedal, refer to "Front Panel" (p. 20) and "Rear Panel (Connections)" (p. 22).

Assigning the ACCEL/CTL, EXP SW, SUB CTL1, and SUB CTL2 Functions

1. Press the [CTL/EXP] button.



2. Turn knob [4] to select the pedal whose assignment you want to specify.

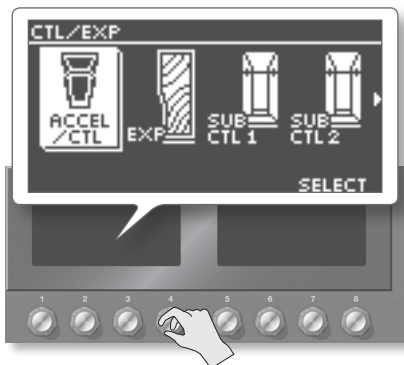

3. Use knob [5]–[8] to set the parameter that you want to control.

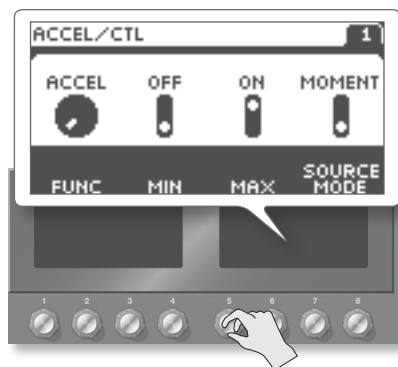

| Parameter | Value | Explanation |
|-----------------|--------------------------|---|
| Page 1 | | |
| [5] FUNC | ACCEL, OFF, ON, MOMENT | You can assign a variety of functions, such as turning each effect on/off or switching the preamp channel. For details on all parameters, download the "GT-100 Parameter Guide" (PDF file) located under "GT-100" in the list of "Owner's Manuals" on the Roland website (http://www.roland.com/support/en/). |
| [6] MIN | OFF, ON (or STOP, START) | This sets the value for times when the switch is Off. |
| [7] MAX | OFF, ON (or STOP, START) | This sets the value for times when the switch is On. |
| [8] SOURCE MODE | MOMENT | This sets the behavior of the value each time the switch is operation. The normal state is Off (minimum value), with the switch On (maximum value) only while the footswitch is depressed. |
| | TOGGLE | The setting is toggled On (maximum value) or Off (minimum value) with each press of the footswitch. |

* To be able to apply an Accel effect (p. 19) using the ACCEL/CTL control pedal, you need to set ACCEL/CTL FUNC to ACCEL, and set SOURCE MODE to MOMENT.

4. Press the [EXIT] button to return to the Play screen.

Assigning the EXP and SUB EXP Pedal Functions

Here's how to assign the parameters that will be controlled by the GT-100's built-in [EXP] pedal, and by an expression pedal (such as the separately available EV-5) connected to the SUB CTL 1, 2/SUB EXP jack.

1. Press the [CTL/EXP] button.

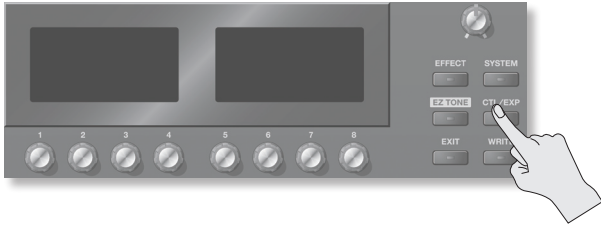

2. Turn knob [4] to select the pedal whose assignment you want to specify.

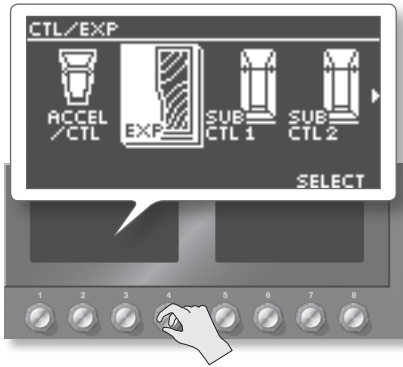

| Parameter | Explanation |
|---------------|---|
| EXP PEDAL | The GT-100's [EXP] pedal |
| SUB EXP PEDAL | The expression pedal (such as the separately available EV-5) connected to the SUB CTL 1, 2/SUB EXP jack |

3. Use knob [5] to select the setting.

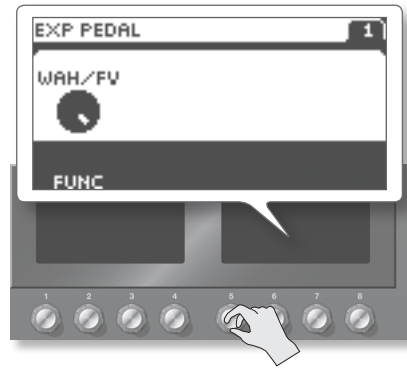

| Parameter | Value | Explanation |
|---------------------|-------------|--|
| [5] FUNC | OFF | No assignment. |
| | FOOT VOLUME | Foot volume will be assigned. |
| | PEDAL BEND | Pedal bend will be assigned. |
| | WAH | Wah will be assigned. |
| | PB/FV | Pedal bend and foot volume will be assigned. |
| | WAH/FV | Wah and foot volume will be assigned. |
| | PATCH LEVEL | Patch level will be assigned. * This is shown only if PERFORMANCE is set to SYSTEM. |
| [6] PATCH LEVEL MIN | 0-200 | Specifies the minimum value. * This is shown only if FUNC is set to PATCH LEVEL. |
| [7] PATCH LEVEL MAX | 0-200 | Specifies the maximum value. * This is shown only if FUNC is set to Patch Level. |

* Only FOOT VOLUME can be assigned to SUB EXP (external expression pedal). If you want to assign a function other than FOOT VOLUME, use Assign (p. 37).

4. Press the [EXIT] button to return to the Play screen.

Assigning the [1]–[8] Knob Functions in the Play Screen

Here's how to assign the functions of the [1]–[8] knobs when they are operated in the Play screen.

1. Press the [SYSTEM] button.



2. Turn knob [4] to select "KNOB SETTING".



3. Use knobs [5]–[8] to select the functions of knobs [1]–[4].

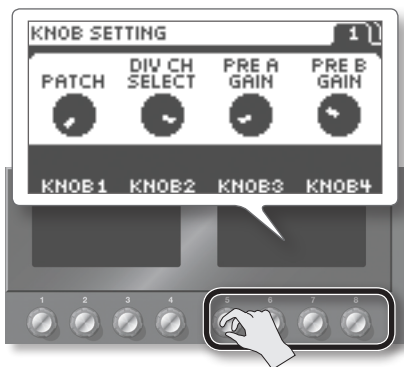

4. Press the PAGE [▶] button to access the next page.

5. Use knobs [5]–[8] to select the functions of knobs [5]–[8].

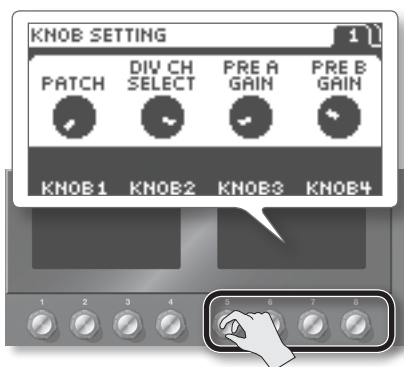

Switching Settings with the Number Pedals

The GT-100 includes a function that allows you to turn the tuner on and off, switch preamp channels, and perform other tasks by pressing the pedal with the same number as the currently selected patch.

* You can switch the following functions in any condition other than the Manual Mode (p. 17).

1. Press the [SYSTEM] button.



2. Turn knob [4] to select "PLAY OPTION".

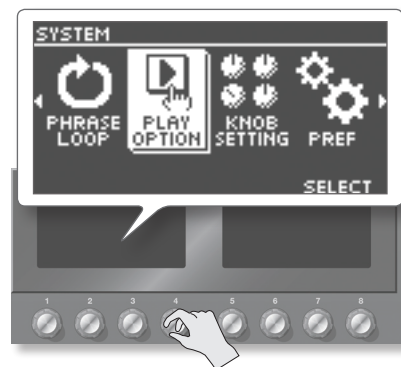

3. Use knob [8] to select the value for NUM PEDAL SW.



| Value | Explanation |
|----------|---|
| OFF | Not used. |
| TUNER | Switches the tuner on and off. |
| Ch. A/B | Switches between preamp channels A and B. |
| OD SOLO | Switches to tones suited to solo performance. |
| A/B SOLO | Switches the preamp SOLO on and off. |
| A&B SOLO | Switches SOLO on or off for both preamp channels A and B. |

Adjusting the [EXP] pedal

Although the GT-100's [EXP] pedal has been set for optimum operation at the factory, extended use and the operating environment can result in the pedal going out of adjustment.

If you encounter problems such as being unable to fully cut off the sound with the volume pedal or being unable to switch the EXP PEDAL SW, you can use the following procedure to readjust the pedal.

1. Press the [SYSTEM] button.



2. Turn knob [4] to select "PDL CALIBRATION" (PEDAL CALIBRATION).

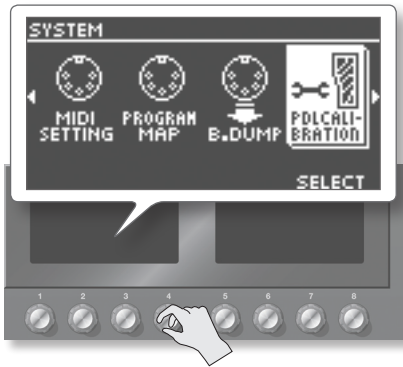

The PEDAL CALIBRATION screen appears.



3. Press the heel end of the [EXP] pedal, and press the [WRITE] button.

The screen will indicate "OK," and then a screen like the following will appear.



4. Press the toe end of the [EXP] pedal, and press the [WRITE] button.

The screen will indicate "OK," and then a screen like the following will appear.

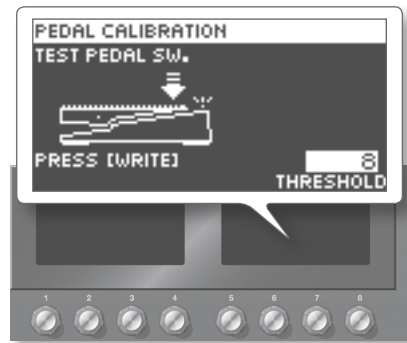

5. Strongly press the toe end of the [EXP] pedal.

Verify that the EXP PEDAL SW indicator lights when you strongly press the toe end.

* If you want to change the lighting sensitivity of the EXP PEDAL SW indicator, repeat step 5 while you adjust the THRESHOLD value with knob [5].

6. Press the [WRITE] button.

The screen will indicate "COMPLETE!"

Setting Each Pedal Functions to Individual Patches (Assign)

You can set the [PHRASE LOOP] Pedal, [ACCEL/CTL], [EXP] pedal, EXP PEDAL SW and external pedals (footswitch and expression pedal) connected to the rear panel's SUB CTL 1, 2/SUB EXP jacks for each individual patch. You can save up to eight separate settings per patch (using Assign numbers 1 through 8) that determine what parameters are controlled by which pedals.

* If you want to use the [PHRASE LOOP] pedal with the assignment you specify, you must turn "PHRASE LOOP PEDAL FUNC" (p. 40) off. For other pedals, you must set "PREFERENCE" (p. 41) to "PATCH."

* You can specify the individual parameter that will be controlled by each pedal.

1. Press the [CTL/EXP] button.



2. Turn knob [4] to select "ASSIGN 1-8."

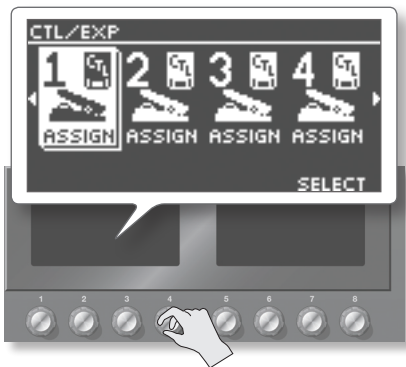

3. Use knobs [5]–[8] to select the desired settings.

ASSIGN COMMON

| Parameter | Value | Explanation |
|-----------|------------|--|
| Page 1 | | |
| [8] | INPUT SENS | 0–100 This adjusts the input sensitivity when INPUT LEVEL is selected for SOURCE. |

ASSIGN 1–8

| Parameter | Value | Explanation | |
|-----------|---------------|---|---|
| Page 1 | | | |
| [5] | ASSIGN ON/OFF | OFF, ON Turns the ASSIGN 1–8 on/off. * This setting is not saved along with the quick settings. | |
| [6] | SOURCE | EXP PEDAL | Assigns the GT-100's built-in [EXP] pedal. |
| | | EXP PDL SW | Assigns the EXP pedal switch. |
| | | P.LOOP PEDAL | Assigns the GT-100's [PHRASE LOOP] pedal. |
| | | ACC/CTL PDL | Assigns the [ACCEL/CTL] pedal. |
| | | SUB EXP PDL | Assigns the external expression pedal (such as the separately available EV-5) connected to the SUB CTL 1, 2/SUB EXP jack. |
| | | SUB CTL1 PDL | Assigns the external footswitch (FS-5U, FS-6; available separately) connected to the SUB CTL 1, 2/SUB EXP jack. |
| | | SUB CTL2 PDL | Assigns the external foot switch (FS-5U, FS-6; available separately) connected to the SUB CTL 1, 2/SUB EXP jack. |
| | | INT PEDAL | Refer to "Virtual expression pedal system (Internal Pedal / Wave Pedal)" (p. 39)) |
| | | WAVE PEDAL | Refer to "Virtual expression pedal system (Internal Pedal / Wave Pedal)" (p. 39) |
| | | INPUT LEVEL | The assigned target parameter will change according to the input level. |
| | CC#1–#31 | Control Change messages from an external MIDI device. | |
| | CC#64–#95 | Control Change messages from an external MIDI device. | |
| [7] | SOURCE MODE | MOMENT | The normal state is Off (minimum value), with the switch On (maximum value) only while the footswitch is depressed. |
| | | TOGGLE | The setting is toggled On (maximum value) or Off (minimum value) with each press of the footswitch. |







Page 2

| | | |
|-----|-----------------|---|
| [5] | TARGET CATEGORY | This selects the parameter to be changed. For details on all parameters, download the "GT-100 Parameter Guide" (PDF file) located under "GT-100" in the list of "Owner's Manuals" on the Roland website (http://www.roland.com/support/en/). |
| [6] | TARGET | |
| [7] | TARGET MIN | This sets the minimum value for the range in which the parameter can change. The value differs depending on the parameter assigned for TARGET parameter. |
| [8] | TARGET MAX | This sets the maximum value for the range in which the parameter can change. The value differs depending on the parameter assigned for TARGET parameter. |

Page 3

| | | |
|-----|--------------|---|
| [5] | ACT RANGE LO | 0–126 You can set the controllable range for target parameters within the source's operational range. Target parameters are controlled within the range set with ACT RANGE LO and ACT RANGE HI. You should normally set ACT RANGE LO to 0 and ACT RANGE HI to 127. |
| [6] | ACT RANGE HI | 1–127 |

Pedal Settings (Control/Expression)

| Parameter | Value | Explanation |
|------------------------|---|--|
| [7] WAVE RATE *1 | 0-100, BPM  | This determines the time spend for one cycle of the assumed EXP Pedal. |
| | When set to BPM, the value of each parameter will be set according to the value of the "Master BPM" specified for each patch. This makes it easier to achieve effect sound settings that match the tempo of the song. * If, due to the tempo, the time is longer than the range of allowable settings, it is then synchronized to a period either 1/2 or 1/4 of that time. | |
| [8] WAVEFORM *1 | SAW  | |
| | TRI  | |
| | SINE  | |
| Page 4 | | |
| [5] INT PDL TRIGGER *2 | PATCH CHANGE | This is activated when a patch is selected. |
| | EXP PDL-LO | This is activated when the GT-100's [EXP] pedal is set to the minimum position. |
| | EXP PDL-MID | This is activated when the GT-100's [EXP] pedal is moved through the middle position. |
| | EXP PDL-HI | This is activated when the GT-100's [EXP] pedal is set to the maximum position. |
| | EXP PDL SW | This is activated when the EXP pedal switch is operated. |
| | P.LOOP PEDAL | This is activated when the [PHRASE LOOP] pedal is operated. |
| | ACC/CTL PDL | This is activated when the [ACCEL/CTL] Pedal is operated. |
| | SUB EXP PDL | This is activated when an external expression pedal connected to the SUB CTL 1, 2/SUB EXP jack is operated. |
| | SUB CTL1 PDL | This is activated when an external footswitch connected to the SUB CTL 1, 2/SUB EXP jack is operated. |
| | SUB CTL2 PDL | This is activated when an external footswitch connected to the SUB CTL 1, 2/SUB EXP jack is operated. |
| | CC#1-#31 | This is activated when a control change is received. |
| | CC#64-#95 | This is activated when a control change is received. |
| [6] INT PDL TIME *2 | 0-100 | This specifies the time over which the internal pedal will move from the toe-raised position to the toe-down position. |
| [7] INT PDL CURVE *2 | LINEAR  | |
| | SLOW RISE  | |
| | FAST RISE  | |

*1 The WAVE RATE and WAVEFORM parameters are enabled when the Source parameter is set to WAVE PEDAL.

*2 The INT PDL TRIGGER, INT PDL TIME, and INT PDL CURVE parameters are enabled when the SOURCE parameter is set to INT PEDAL.

About the Range of a Target's Change

The value of the parameter selected as the target changes within the range defined by "Min" and "Max," as set on the GT-100.

When using an external footswitch, or other controller that acts as an on/off switch, "Min" is selected with Off (CLOSED), and "Max" is selected with On (OPEN).

When using an external expression pedal or other controller that generates a consecutive change in the value, the value of the setting changes accordingly, within the range set by the minimum and maximum values. Also, when the target is of an on/off type, the median value of the received data is used as the dividing line in determining whether to switch it on or off.

When using the footswitch:

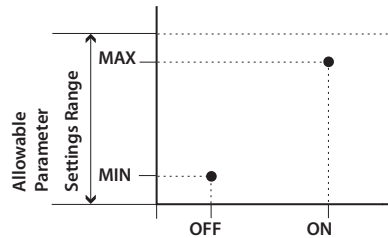

When using the expression pedal:

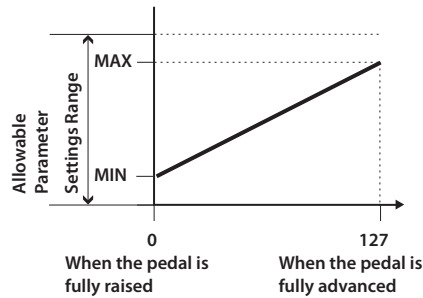

When controlling the On/Off target with the expression pedal:

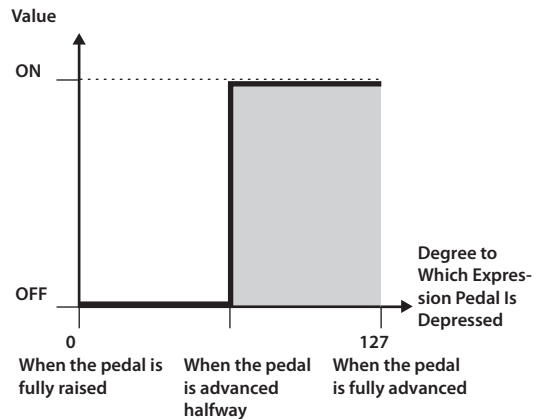

*The range that can be selected changes according to the target setting.

*When the "minimum" is set to a higher value than the "maximum," the change in the parameter is reversed.

*The values of settings can change if the target is changed after the "minimum" and "maximum" settings have been made. If you've changed the target, be sure to recheck the "minimum" and "maximum" settings.

About the Range of a Controller's Change

This sets the operational range within which the value of the setting changes when an expression pedal or other controller that changes the value consecutively is used as the source. If the controller is moved outside the operational range, the value does not change, it stops at "minimum" or "maximum."

(Example) With ACT RANGE LO: 40, ACT RANGE HI: 80

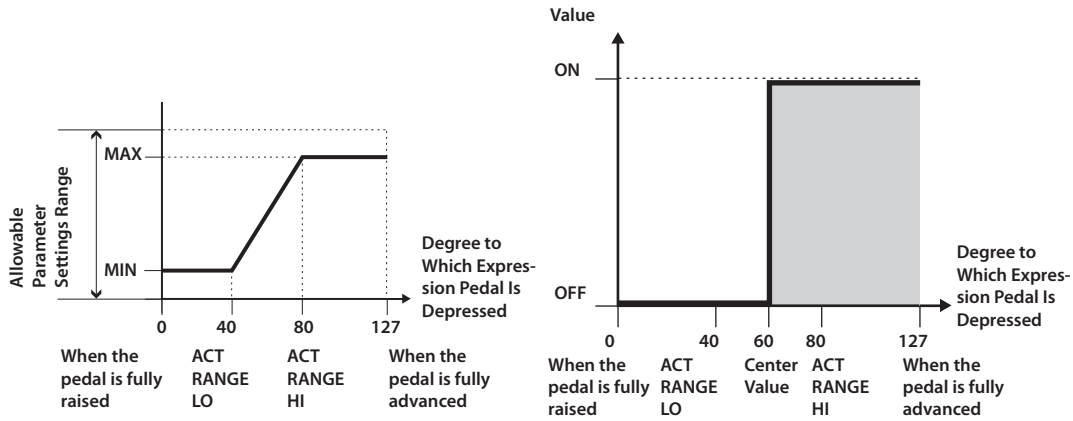

*When using a footswitch or other on/off switching controller as the source, leave these at "ACT RANGE LO: 0" and "ACT RANGE HI: 127." With certain settings, the value may not change.

Virtual expression pedal system (Internal Pedal / Wave Pedal)

By assigning a desired parameter to the virtual expression pedal, you can produce an effect as though you were operating a physical expression pedal to change the volume or tone quality in real time.

The virtual expression pedal system provides the following two types of functions, and you can use the SOURCE (p. 37) setting for ASSIGN 1–8 to choose the desired type.

* If you want to use the internal pedal or wave pedal, set the ASSIGN parameter SOURCE MODE to "MOMENT"

Internal Pedal

If SOURCE is set to "INT PEDAL," the virtual expression pedal will begin operating when started by the specified trigger (INT PDL TRIGGER, p. 38), modifying the parameter specified by TARGET (p. 37).

Reference

For more detailed information on the parameters that can be set using Internal Pedal, refer to "INT PDL TRIGGER (Internal Pedal Trigger)" (p. 41), "INT PDL TIME (Internal Pedal Time)" (p. 38), and "INT PDL CURVE (Internal Pedal Curve)" (p. 38).

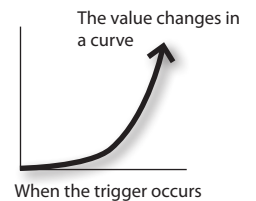

Wave Pedal

If SOURCE is set to "WAVE PEDAL" the virtual expression pedal will cyclically modify the parameter specified by TARGET (p. 37) in a fixed wave form.

Reference

For more detailed information on the parameters that can be set using Wave Pedal, refer to "WAVE RATE (Wave Pedal Rate)" (p. 38) and "WAVEFORM (Wave Pedal Form)" (p. 38).

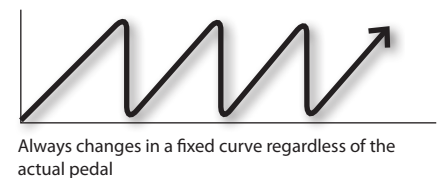

Input Level

Input Level

The parameter set as the target changes in response to the input level.

MEMO

If you want to adjust the input sensitivity, set the "INPUT SENS"(p. 37).

Making Global Settings (System Settings)

Settings that are shared by the entire GT-100 are called “system settings.”

Reference

For details, refer to “Editing: Basic Operation” (p. 12).

List of Settings

| Item | Parameter | Value | Explanation |
|---|--|---|--|
| Specifying the Output Device You’re Using (OUTPUT SELECT) | | | |
| Specify the device (amp) that’s connected to the OUTPUT jacks. | | | |
| OUTPUT SELECT | SELECT | JC-120, SMALL AMP, COMBO AMP, STACK AMP, JC-120 RETURN, COMBO RETURN, STACK RETURN, LINE/PHONES | Refer to “Specify the type of amp you’ve connected” (p. 9). |
| Adjusting the Input Level from Your Guitar | | | |
| Adjust the input level according to the output level of the guitar that you’ve connected. | | | |
| INPUT | INPUT LEVEL | -20+20 dB | Adjusts the guitar input level. |
| Adjusting the Overall Tone (Global EQ) | | | |
| This adjusts the tone of the OUTPUT regardless of the equalizer on/off settings of individual patches. | | | |
| GLOBAL EQ | LOW GAIN | -20+20 dB | Adjusts the low frequency range tone. |
| | MID GAIN | -20+20 dB | Adjusts the middle frequency range tone. |
| | MID FREQ | 20.0 Hz–10.0 kHz | Specifies the center of the frequency range that will be adjusted by the MID GAIN. |
| | MID Q | 0.5–16 | Adjusts the width of the area affected by the EQ centered at the MID FREQ. Higher values will narrow the area. |
| | HIGH GAIN | -20+20 dB | Adjusts the high frequency range tone. |
| Adjusting the Overall Noise Suppressor, Reverb, and Output Level (Total) | | | |
| These parameters control the threshold level of the noise suppressor used by each patch, the overall reverb level, and the overall output. They do not affect the settings of each patch. | | | |
| TOTAL | NS THRESH | -20+20 dB | Control the threshold level of the noise suppressor used by each patch. This does not affect the settings of each patch. * If you want to use the settings specified for each patch, set this to 0 dB. |
| | REVERB | 0–200 % | Adjusts the reverb level specified for each patch. It is useful to adjust the reverb level appropriately for the space in which you’re performing. This does not affect the settings of each patch. * If you want to use the settings specified for each patch, set this to 100 %. |
| | MAIN OUTPUT LEVEL | -10 dB, +4 dB | Specifies the output reference level as appropriate for the input level of the device connected to the OUTPUT jacks. |
| Making Phrase Loop (p. 32) Settings | | | |
| PHRASE LOOP | Here are various settings for the Phrase Loop function. Refer to “Setting Phrase Loop” (p. 32) | | |

| Item | Parameter | Value | Explanation |
|---|---|---|--|
| Making the PLAY OPTION Settings | | | |
| Here you can specify how the pedals will work during performance. | | | |
| PLAY OPTION | BANK CHANGE MODE | WAIT | Although the indication in the display is updated to reflect the change in the bank when a BANK pedal is pressed, the patch will not change until a number pedal has been pressed. |
| | | IMMED | The patch switches instantly when a BANK pedal or any of the number pedals is pressed. |
| | EXP PEDAL HOLD | OFF | The operational status of the EXP PEDAL's FUNC (p. 34) is not carried over when patches are switched. |
| | | ON | If the EXP PEDAL's FUNC (p. 34) are the same between 2 patches, the operational status is carried over when patches are switched. For example, if EXP PEDAL FUNC is set to FOOT VOLUME in both patches, the one before and the one after the change, the volume corresponding to the position the pedal is in (angle) at the time of the patch change will be maintained after the patch change. On the other hand, if the patch being changed to is set to WAH, the volume will be in accordance with the value set within the patch, and you'll obtain a wah effect that is in accordance with a value that reflects the current position (angle) of the pedal. |
| | KNOB LOCK | OFF, ON | Specifies whether knob operations will be disabled. If this is ON, knob operations will be disabled. |
| | NUM PEDAL SW | OFF, TUNER, Ch.A/B, OD SOLO, A/B SOLO, A&B SOLO | Selects the function that will be recalled when you press the pedal of the same number as the currently selected patch (p. 35). |
| | BANK EXTENT MIN | U01–U50, P01–P50 | Sets the lower limit for the banks. |
| | BANK EXTENT MAX | U01–U50, P01–P50 | Sets the upper limit for the banks. |
| | PEDAL INDICAT | OFF, ON | If this is ON, all currently unlit pedal indicators will blink dimly. |
| Assigning the [1]–[8] Knob Functions in the Play Screen | | | |
| Here you can assign the desired parameters to knobs [1]–[8] in the Play Screen (p. 35). * The settings you make here are only for the knobs in the Play Screen. | | | |
| KNOB SETTING | KNOB 1 | OFF, parameter name | For details on all parameters, refer to the "GT-100 Parameter Guide" (PDF file) which you can download from the Roland website (http://www.roland.com/support/en/) under "GT-100" in the list of "Owner's Manuals." |
| | KNOB 2 | | |
| | KNOB 3 | | |
| | KNOB 4 | | |
| | KNOB 5 | | |
| | KNOB 6 | | |
| | KNOB 7 | | |
| | KNOB 8 | | |
| Specifying Whether Settings Will Be Shared by All Patches | | | |
| Here you can specify whether settings for the type of connected amp and preamp, control pedal, expression pedal, etc. will be independent for each patch, or whether the same settings will be shared by all patches. | | | |
| PREFERENCE | OUTPUT SELECT | PATCH, SYSTEM | If this is set to PATCH, different settings can be made independently for each patch. If this is set to SYSTEM, the same settings will be shared by all patches. * Here, even if a CTL/EXP pedal that has been set to SYSTEM is set to ASSIGN SOURCE (p. 37), that setting will be ignored. In the case of the ACCEL/CTL pedal, in addition to the above, settings for Manual mode (p. 17) will also be ignored. |
| | PREAMP | PATCH, SYSTEM1–3 | |
| | ACCEL/CTL | PATCH, SYSTEM | |
| | EXP | PATCH, SYSTEM | |
| | EXP SW | PATCH, SYSTEM | |
| | SUB CTL1 | PATCH, SYSTEM | |
| | SUB CTL2 | PATCH, SYSTEM | |
| | SUB EXP | PATCH, SYSTEM | |
| Adjusting the Contrast (Brightness) of the LCD Screen | | | |
| LCD | Here you can adjust the brightness of the characters in the display. | | |
| | CONTRST LEFT | 1–16 | Higher values increase the brightness. |
| CONTRST RIGHT | | | |
| Adjusting the [EXP] pedal | | | |
| PEDAL CALIBRATION | You can readjust the [EXP] pedal so that it will operate optimally. Refer to "Adjusting the [EXP] pedal" (p. 36). | | |
| | THRESHOLD | 1–16 | Adjusts the sensitivity at which the EXP PEDAL SW will respond. |

Making Global Settings (System Settings)

| Item | Parameter | Value | Explanation |
|---------------|---|---|---|
| AUTO OFF | Auto Off Settings | | |
| | <p>The GT-100 can turn off its power automatically. The power will turn off automatically when 10 hours have passed since you last played or operated the unit. The display will show a message approximately 15 minutes before the power turns off.</p> <p>With the factory settings, this function is turned "ON" (power-off in 10 hours). If you want to have the power remain on all the time, turn it "OFF."</p> | | |
| | <p>NOTE</p> <p>When the power is turned off, any settings you were editing will be lost. You must save settings that you want to keep.</p> | | |
| | AUTO OFF | OFF | The power will not turn off automatically. |
| | | ON | The power will automatically turn off when 10 hours have passed since you last played or operated the GT-100. |
| FACTORY RESET | Restoring the Factory Settings (Factory Reset) | | |
| | <p>Initializes the GT-100 to its factory-set condition. Refer to "Restoring the Factory Settings (Factory Reset)" (p. 50).</p> <p>* When you execute "Factory Reset," the settings you made will be lost. If you want to keep your data, save it to your computer as described in "Transmitting Data to an External MIDI Device (Bulk Dump)" (p. 48).</p> | | |
| | FROM | SYSTEM | System parameter settings |
| | | QUICK | Settings for User Quick Setting |
| | | U01-1–U50-4 | Settings for Patch Number U01-1 through U50-4 |
| | TO | SYSTEM | System parameter settings |
| | | QUICK | Settings for User Quick Setting |
| U01-1–U50-4 | | Settings for Patch Number U01-1 through U50-4 | |

USB-Related Settings

Here you can make USB-related settings for when the GT-100 is connected to a computer via USB.

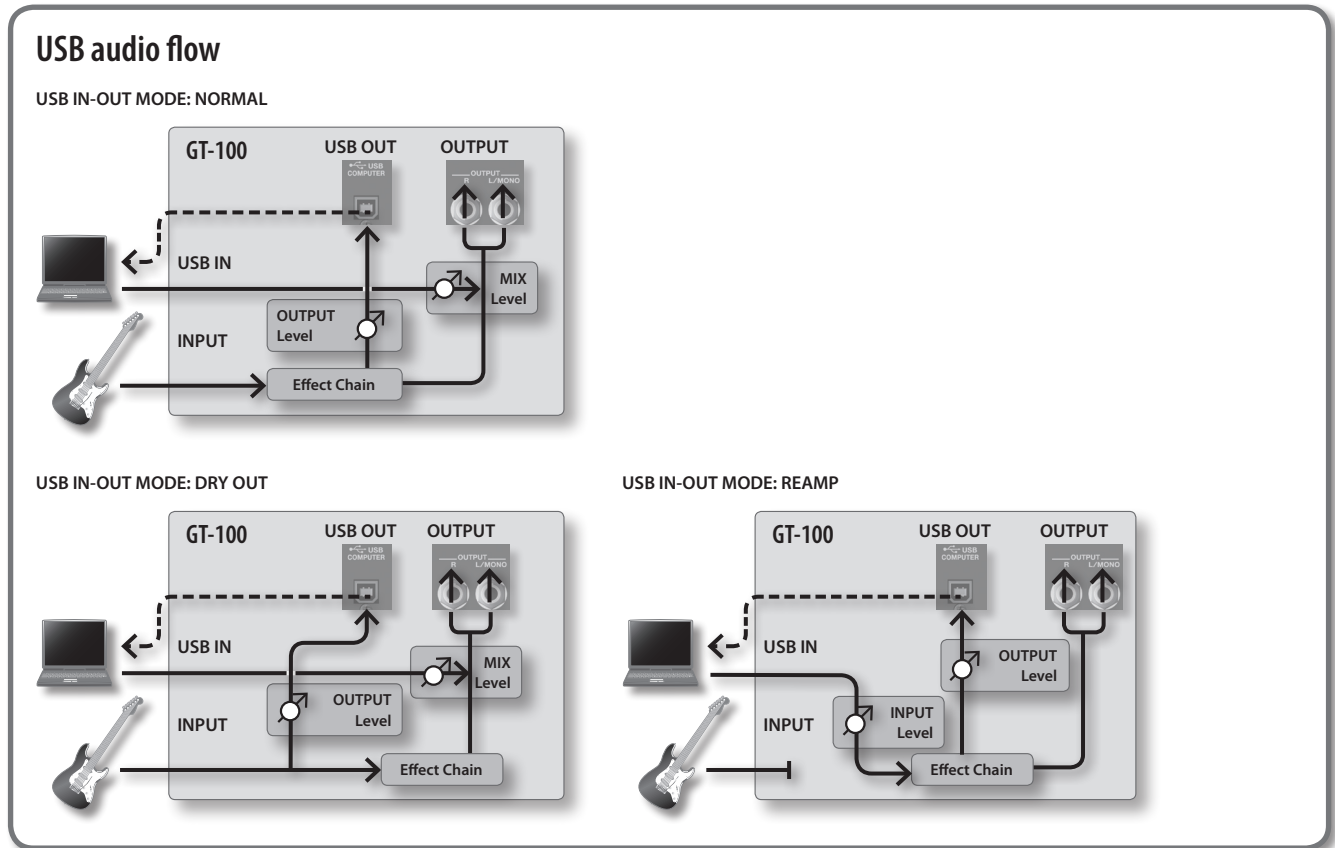

Reference

For details on USB connection, refer to "Using the GT-100 Connected to a Computer Via USB" (p. 49).

USB

| Parameter | Value | Explanation |
|---|--|---|
| Setting the USB audio flow | | |
| Here you can specify the audio flow for USB input/output. | | |
| USB IN-OUT MODE | NORMAL | The guitar input will be sent through the GT-100's effects and output to the computer. The input from the computer will be mixed with the GT-100's output, and then output. |
| | DRY OUT | The sound of the guitar processed by the effects will be monitored, while the guitar input will be output to the computer without passing through the GT-100's effects. The input from the computer will be mixed with the GT-100's output (effect-processed guitar sound) and then output. |
| | REAMP | The sound being input from the computer will pass through the GT-100's effects, and then be output from the GT-100's OUTPUT and USB OUT. With this setting, the guitar sound recorded on the computer can be played back through the GT-100's effects and output from the GT-100's guitar OUTPUT and USB OUT. * If REAMP is selected, the GT-100's INPUT cannot be used. |
| Setting the MIX LEVEL | | |
| MIX LEVEL | Adjusts the level of the audio input from the computer that will be mixed with the sound processed by the GT-100's effects when "USB IN-OUT MODE" is not set to "REAMP". | |
| | 0-200 % | Adjusts the level of the audio input from the computer that will be mixed with the sound processed by the GT-100's effects. |
| Setting the INPUT LEVEL | | |
| INPUT LEVEL | Adjusts the input level from the computer to the GT-100's effects when "USB IN-OUT MODE" is set to "REAMP". | |
| | -20~+20 dB | Adjusts the input level from the computer to the GT-100's effects . |

Quick Guide

Overview

Outputting Sound

Effects

Saving

Pedal Settings

System

MIDI/USB

Appendices

Making Global Settings (System Settings)

| Parameter | Value | Explanation |
|------------------|---|--|
| OUTPUT LEVEL | Setting the OUTPUT LEVEL | |
| | Adjusts the level of the output from the GT-100 to the computer. | |
| | 0–200 % | Adjusts the level of the output to the computer. |
| DIR. MONITOR | Setting the Direct Monitor | |
| | Switches the output of the GT-100 sound to the OUTPUT and PHONES jacks. * This setting cannot be saved. It is set to ON when the power is turned on. * If you are using the special driver, you can control DIR. MONITOR On/Off from ASIO 2.0-compatible application. | |
| | OFF | Set this to Off if transmitting audio data internally through a computer (Thru). No sound is heard at this time unless the setting for the computer is Thru. |
| | ON | The GT-100 sound is output. Set this to ON when using the GT-100 as a standalone device, without connecting to a computer (only USB input sound will be output if this is set to Off). |
| DIR. MONITOR CMD | Controlling the Direct Monitor Setting from a Computer | |
| | This setting determines whether or not the command (the Direct Monitor command) controlling the Direct Monitor setting is enabled. | |
| | DISABLE | The Direct Monitor command is disabled, maintaining the Direct Monitor mode set by the GT-100. |
| | ENABLE | The Direct Monitor command is enabled, allowing the Direct Monitor mode to be switched from an external device. |

MIDI-Related Settings

Here you can make settings for using the GT-100 connected with an external MIDI device or with a second GT-100 unit.

Reference

For details on MIDI, refer to “Using the GT-100 with External MIDI Devices Connected” (p. 47).

MIDI SETTING

| Parameter | Value | Explanation |
|------------|--|---|
| RX CHANNEL | Setting the MIDI Receive Channel | |
| | This sets the MIDI channel used for receiving MIDI messages. | |
| | Ch. 1– Ch. 16 | Specifies the receive channel. |
| OMNI MODE | Setting the MIDI Omni Mode | |
| | This makes the settings for the channels used for MIDI information. | |
| | OFF | Information is received on the channel specified by the Rx Channel setting. |
| | ON | Messages are received on all channels, regardless of the MIDI channel settings. |
| TX CHANNEL | Setting the MIDI Transmit Channel | |
| | This sets the MIDI channel used for transmitting MIDI messages. | |
| | Ch. 1– Ch. 16. | Specifies the transmit channel. |
| | RX | Transmits on the same channel as the RX CHANNEL. |
| DEVICE ID | Setting the MIDI Device ID | |
| | This sets the MIDI Device ID used for transmitting and receiving Exclusive messages. | |
| | 1–32 | Sets the MIDI Device ID. |
| SYNC CLOCK | Setting the MIDI Sync Clock | |
| | This setting determines the basis used for synchronizing the timing for effect modulation rates and other time-based parameters. * When you have an external MIDI device connected, the Master BPM is then synchronized to the external MIDI device's tempo, thus disabling the Master BPM setting. To enable setting of the Master BPM, set to “INTERNAL.” * When synchronizing performances to the MIDI Clock signal from an external MIDI device, timing problems in the performance may occur due to errors in the MIDI Clock. | |
| | AUTO | Operations are synchronized to the MIDI Clock received via MIDI. However, operations are automatically synchronized to the GT-100's internal Clock if the GT-100 is unable to receive the external Clock. |
| | INTERNAL | Operations are synchronized to the GT-100's internal Clock. |

| Parameter | Value | Explanation |
|---|---|--|
| Selecting the Connector That Will Receive MIDI Messages | | |
| MIDI IN SELECT | This selects whether MIDI messages will be received from the MIDI IN connector or from the USB port. | |
| | USB (AUTO) | MIDI messages will be received via the USB port. * If the USB port is not connected to a computer, MIDI messages will be received from the MIDI IN connector. |
| | MIDI CONNECTOR | MIDI messages will be received from the MIDI IN connector. |
| Sending Program Change Messages | | |
| PC OUT | This setting determines whether or not Program Change messages are output when patches are switched on the GT-100. * On the GT-100, Bank Select messages are output simultaneously with Program Change messages. | |
| | OFF | Program Change messages are not output, even when patches are switched. |
| | ON | Program Change messages are simultaneously output when patches are switched. |
| Enabling/Disabling the Program Change Map Settings (MIDI Map Select) | | |
| MAP SELECT | This setting determines whether patches are switched according to the Program Change Map settings, or to the default settings "Setting the Program Change Map" (p. 47). | |
| | FIX | This deactivates the Program Change Map. Switches to the patches according to the default settings. |
| | PROG | This activates the Program Change Map. Switches to the patches according to the Program Change Map. |
| Sending [PHRASE LOOP] Pedal Operations as Control Change Messages | | |
| PH.LOOP OUT | This sets the controller number when [PHRASE LOOP] pedal switch operation data is output as Control Change messages. | |
| | OFF | Control Change messages are not output. |
| | CC#1–CC#31, CC#64–CC#95 | This sets the controller number when [PHRASE LOOP] pedal operation data is output as Control Change messages. |
| Sending [ACCEL/CTL] Pedal Operations as Control Change Messages | | |
| ACC/CTL OUT | This sets the controller number when [ACCEL/CTL] pedal switch operation data is output as Control Change messages. | |
| | OFF | Control Change messages are not output. |
| | CC#1–CC#31, CC#64–CC#95 | This sets the controller number when [ACCEL/CTL] pedal operation data is output as Control Change messages. |
| Sending [EXP] Pedal Operations as Control Change Messages | | |
| EXP OUT | This sets the controller number when [EXP] pedal operation data is output as Control Change messages. | |
| | OFF | Control Change messages are not output. |
| | CC#1–CC#31, CC#64–CC#95 | This sets the controller number when [EXP] pedal operation data is output as Control Change messages. |
| Sending EXP Pedal Sw Operations as Control Change Messages | | |
| EXP SW OUT | This sets the controller number when EXP PEDAL SW operation data is output as Control Change messages. | |
| | OFF | Control Change messages are not output. |
| | CC#1–CC#31, CC#64–CC#95 | This sets the controller number when EXP PEDAL SW operation data is output as Control Change messages. |
| Sending External Footswitch Operations as Control Change Messages | | |
| SUB CTL1 OUT | This sets the controller number when operation data from the footswitch connected to the SUB CTL 1, 2/SUB EXP jack is output as Control Change messages. | |
| | OFF | Control Change messages are not output. |
| | CC#1–CC#31, CC#64–CC#95 | This sets the controller number when SUB CTL1 pedal operation data is output as Control Change messages. |
| SUB CTL2 OUT | OFF | Control Change messages are not output. |
| | CC#1–CC#31, CC#64–CC#95 | This sets the controller number when SUB CTL2 pedal operation data is output as Control Change messages. |

Making Global Settings (System Settings)

| Parameter | Value | Explanation |
|-------------|--|--|
| SUB EXP OUT | Sending External Expression pedal Operations as Control Change Messages | |
| | This sets the controller number when operation data from the expression pedal connected to the SUB CTL 1, 2/SUB EXP jack is output as Control Change messages. | |
| | OFF | Control Change messages are not output. |
| | CC#1–CC#31, CC#64–CC#95 | This sets the controller number when external SUB EXP Pedal operation data is output as Control Change messages. |

MIDI PROGRAM CHG MAP BANK 0–3

| Parameter | Value | Explanation |
|-------------|--|---|
| PC#1–PC#128 | Setting the Program Change Map | |
| | When switching patches using Program Change messages transmitted by an external MIDI device, you can freely set the correspondence between Program Change messages received by the GT-100 and the patches to be switched to in the "Program Change Map." "Setting the Program Change Map" (p. 47) | |
| | U01-1–U50-4, P01-1–P50-4 | This sets the patch number (U01-1 through P50-4) for the corresponding Program Change number. |

MIDI BULK DUMP

| Parameter | Value | Explanation |
|-----------|---|---|
| FROM | Transmitting Data to an External MIDI Device | |
| | You can use Exclusive messages to provide another GT-100 with identical settings, and save effect settings on a MIDI sequencer or other device "Transmitting Data to an External MIDI Device (Bulk Dump)" (p. 48). | |
| | SYSTEM | System parameter settings |
| | QUICK | Settings for User Quick Setting |
| | U01-1–U50-4 | Settings for Patch Number U01-1 through U50-4 |
| TO | TEMP | Settings for the patch that is currently selected |
| | SYSTEM | System parameter settings |
| | QUICK | Settings for User Quick Setting |
| | U01-1–U50-4 | Settings for Patch Number U01-1 through U50-4 |
| | TEMP | Settings for the patch that is currently selected |

Using the GT-100 with External MIDI Devices Connected

What Can You Do with MIDI?

You can perform the following operations using MIDI with the GT-100.

MEMO

The use of MIDI requires that the MIDI channels of the connected devices match. If the MIDI channel settings are not correct, the GT-100 will be unable to exchange data with other MIDI devices.

For information on how to set the MIDI channel, see "MIDI-Related Settings" ("MIDI-Related Settings" (p. 44)).

Operating From the GT-100

Outputting Program Change Messages

When a patch is selected on the GT-100, a Program Change message corresponding to the patch number is transmitted simultaneously. The external MIDI device then switches its settings according to the Program Change message it receives.

When PC OUT (p. 45) is set to OFF, no Program Change messages will be output.

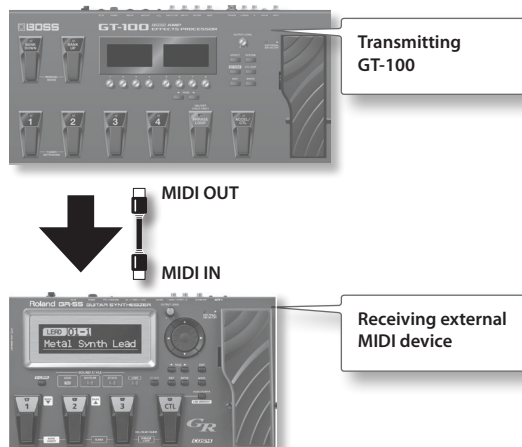

Outputting Control Change Messages

Data describing the actions of the [ACCEL/CTL] Pedal, [EXP] pedal, EXP PEDAL SW, and external devices connected to the SUB CTL 1, 2/SUB EXP jack are output as Control Change messages. Such messages can be used to (among other things) manipulate the parameters of an external MIDI device.

The Control Change numbers that will be output can be set under "MIDI SETTING" ("MIDI SETTING" (p. 44)).

Remotely Controlling the GT-100 Using an External MIDI Device

Switching Patch Numbers

When the GT-100 receives Program Change messages from the external MIDI device, its patches are simultaneously switched.

MEMO

You can set up the correspondence between MIDI Program Change messages and the GT-100's patches using the Program Change Map (p. 46). You may need to work on these correspondences when you want to line up some effects in combination with other MIDI devices.

Receiving Control Change Messages

MEMO

You can control specified parameters during a performance by having the GT-100 receive Control Change messages. Parameters to be controlled are set with "Assign" (p. 37).

Receiving Tempo Data

The GT-100 can receive tempo data from an external device.

Receiving Data

The GT-100 can receive data transmitted from another GT-100, as well as data that's been stored on a sequencer.

Setting the Program Change Map

When switching patches using Program Change messages transmitted by an external MIDI device, you can freely set the correspondence between Program Change messages received by the GT-100 and the patches to be switched to in the "Program Change Map."

MEMO

When setting MIDI OMNI MODE (p. 44) to "OMNI OFF", be sure to have the MIDI RX CHANNEL (p. 44) set beforehand to match the transmit channel of the external MIDI device.

1. Press the [SYSTEM] button.
2. Turn knob [4] to select "PROGRAM CHG MAP" (MIDI - PROGRAM MAP).

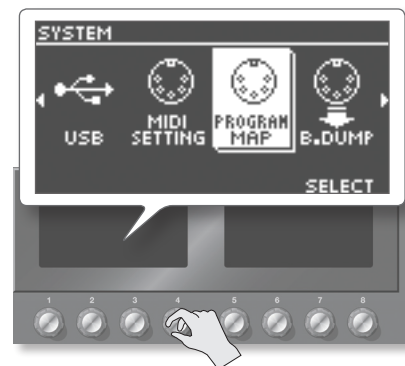

3. Use PAGE [◀][▶] buttons to select one of the choices "BANK 0" – "BANK 3."
4. Turn knob [5] to select the Program Change number.

| Program Change number | Patch number |
|-----------------------|--------------------------|
| PC#1-PC#128 | U01-1-U50-4, P01-1-P50-4 |

5. Use knob [8] to select the patch number.

* In order to activate the use of a Program Change Map, you need to set MAP SELECT (p. 45) to "PROG." When this is set to "FIX," the settings for the Program Change Map will be ignored.

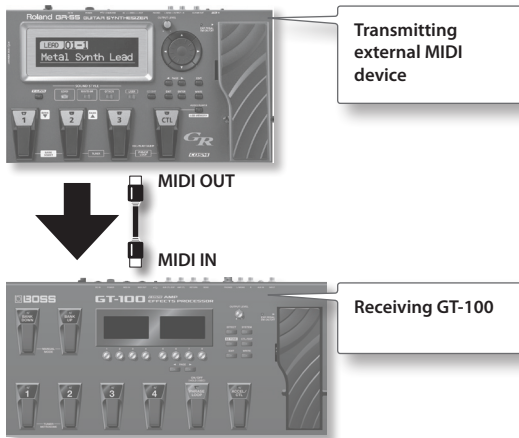

Transmitting the Data

1. Press the [SYSTEM] button.
2. Turn knob [4] to select "B.DUMP" (MIDI - BULK DUMP).



3. Turn knobs [5] and [8] to select the range of data (FROM, TO) that you want to transmit.

| Knob | Parameter | Value | Explanation |
|------------|------------|-------------|---|
| [5] [8] | FROM TO | SYSTEM | System parameter settings |
| | | QUICK | Settings for User Quick Setting |
| | | U01-1-U50-4 | Settings for Patch Number U01-1 through U50-4 |
| | | TEMP | Settings for the patch that is currently selected |

4. Press the [WRITE] button.
Bulk data transmission will begin.

Transmitting Data to an External MIDI Device (Bulk Dump)

With the GT-100, you can use Exclusive messages to set another GT-100 to the same settings or to save effect sound settings to MIDI sequencers and other such devices. This transmission of data is referred to as bulk dump.

Making Connections

MEMO

For instructions on operating the sequencer, refer to the owner's manual for the sequencer you are using.

* If you want to save your settings to sequencer or DAW software on your computer, refer to "Using the GT-100 Connected to a Computer Via USB" (p. 49).

When Transmitting Data to Another GT-100

Connect as shown in the figure below, and match the Device ID for the transmitting and receiving devices.

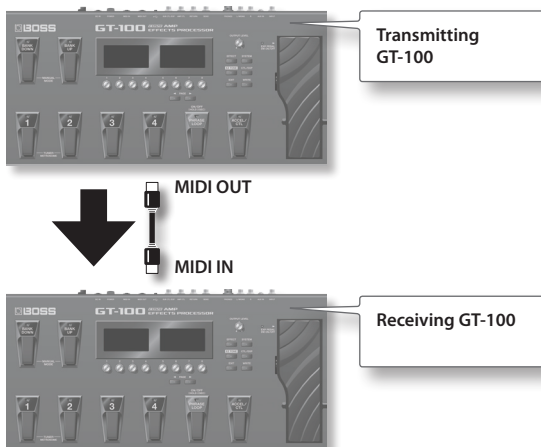

Using the GT-100 Connected to a Computer Via USB

Before Connecting with USB

With the GT-100, you can use USB to transmit both digital audio signals between the GT-100 and your computer.

Installing the USB Driver

Just by connecting the GT-100 to your PC/Mac with a USB cable, audio signal can be transferred bidirectionally via USB.

By using the specialized driver, you can record, play back, and edit audio with high-quality sound and stable timing (p. 47).

You can download the special GT-100 driver from the Roland local website.

You must install the dedicated driver before you make USB connections.

The program and procedures for installing the driver vary according to the operating environment; carefully read the Readme included in the downloaded file.

What is a USB Driver?

A USB driver is software that acts as a go-between in transferring data between computer applications (such as recording software and sequencer software) and the USB device when the computer and USB device are connected using a USB cable.

The USB driver transmits data from the applications to the USB device, and conversely, passes messages from the USB device to the applications.

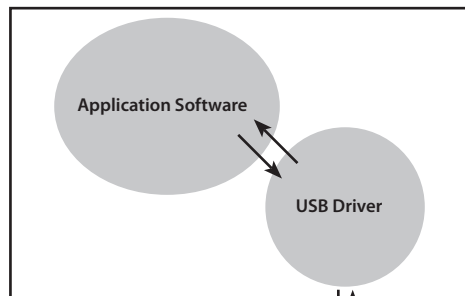

Computer



GT-100

Exchanging MIDI Messages between the Computer and the GT-100

If you connect the GT-100 to your PC/Mac by a USB cable, you can transfer MIDI message bidirectionally via USB. Set the GT-100's "MIDI IN SELECT" (p. 45) to "USB (Auto)." On your computer, set the MIDI input/output ports to "GT-100."

However, MIDI message transfer via GT-100's MIDI connectors become inactivated in this situation.

Reference

For more on MIDI-related settings, refer to "MIDI-Related Settings" (p. 44)

Connecting the Computer

Make connections as shown in the illustration below.

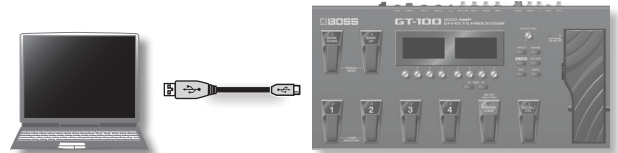

Receiving Bulk Data That Was Saved on the Computer

Bulk data transmitted from MIDI sequencer software can be received by the GT-100 to restore its settings.

Set the GT-100's Device ID to the same number that was used when the data was transmitted to the MIDI sequencer (p. 44).

1. Transmit the data from the computer.

* For instructions on operating the sequencer, refer to the owner's manual for the sequencer you are using.

MEMO

- When data is being received, the message "BULK DATA RECEIVING..." appears on the display.
- Keep the power on while the bulk data is being received.
- If the message "MIDI BUFFER FULL" appears, check the connections and reduce the tempo of the transmitting MIDI device.

Transmitting/Receiving Audio Signals Between a Computer and the GT-100

The GT-100's sound can be recorded on a computer, and sound from the computer can be played through the GT-100. You can change the audio signal flow to suit your purpose.

Reference

- For more about USB settings, refer to "USB-Related Settings" (p. 43).
- For details on how to switch the audio input on the computer software, refer to the manual for the software you're using.

Restoring the Factory Settings (Factory Reset)

Restoring the GT-100's system settings (System parameters) to their original factory default settings is referred to as "Factory Reset."

Not only can you return all of the settings to the values in effect when the GT-100 was shipped from the factory, you can also specify the items to be reset.

- * When you execute "Factory Reset," the settings you made will be lost. If you want to keep your data, you must save it on a computer as described in "Transmitting Data to an External MIDI Device (Bulk Dump)" (p. 48).
- * PEDAL CALIBRATION won't be initialized as the result of a "Factory Reset" (p. 36).

1. Press the [SYSTEM] button.



2. Turn knob [4] to select "FACTORY RESET."

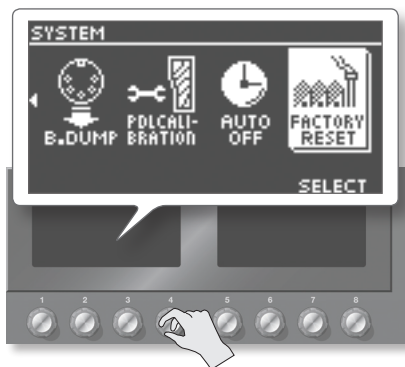

3. Use knobs [5] and [8] to specify the areas that will be returned to their factory-set state.

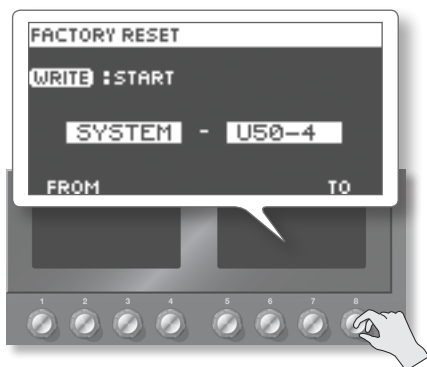

4. Press the [WRITE] button.

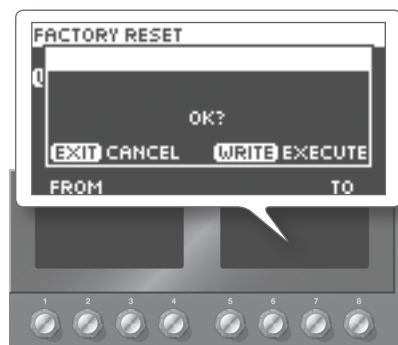

5. To execute the Factory Reset, press the [WRITE] button.

When the Factory Reset is completed, you'll be returned to the Play screen.

If you decide to cancel without executing, press the [EXIT] button.

| Knob | Parameter | Value | Explanation |
|------------|------------|-------------|---|
| [5] [8] | FROM TO | SYSTEM | System parameter settings |
| | | QUICK | Settings for User Quick Setting |
| | | U01-1-U50-4 | Settings for Patch Number U01-1 through U50-4 |

Appendices

GT-100 Effects Guide

GT-100 Effects List

This is a list of the effects built into the GT-100.

* The product names mentioned in this document are registered trademarks or trademarks of their respective owners. In this manual, these names are used because it is the most practical way of describing the sounds that are simulated using COSM technology.

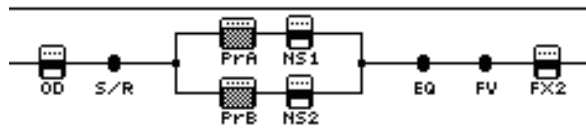

| Effect | Explanation |
|---------------------------------|--|
| COMP (Compressor) | This is an effect that produces a long sustain by evening out the volume level of the input signal. You can switch it to a limiter to suppress only the sound peaks and prevent distortion. |
| OD/DS (Overdrive/Distortion) | This effect distorts the sound to create long sustain. It provides 21 types of distortion and custom settings. For the types of distortion that can be selected for OD/DS, refer to "OD/DS Type List." |
| PREAMP | COSM technology simulates different preamp characteristics, speaker sizes, and cabinet shapes. For the amp types that can be selected for the preamp, refer to "Preamp Type List." |
| EQ (Equalizer) | This adjusts the tone as an equalizer. A parametric type is adopted for the high-middle and low-middle range. |
| FX1 | With FX1 and FX2, you can select the effect to be used from the following. You can select the same effect for FX1 and FX2. For the effects that can be selected for FX1 and FX2, refer to "FX1/FX2 Effect List." |
| FX2 | |
| DELAY | This effect adds delayed sound to the direct sound, giving more body to the sound or creating special effects. |
| CHORUS | In this effect, a slightly detuned sound is added to the original sound to add depth and breadth. |
| REVERB | This effect adds reverberation to the sound. |
| NS1 | This effect reduces the noise and hum picked up by guitar pickups. Since it suppresses the noise in synchronization with the envelope of the guitar sound (the way in which the guitar sound decays over time), it has very little effect on the guitar sound, and does not harm the natural character of the sound. |
| NS2 | |
| DIVIDER | Within the effect chain, the point where the signal is split into channels "A" and "B" is called the "divider," and the point where the two signals are recombined is called the "mixer." |
| MIXER | You can use the divider to switch between channels "A" and "B," to assign strongly picked notes and softly picked notes to different channels, or to assign different frequency bands of your guitar sound to different channels. The mixer lets you adjust the volume balance of channels "A" and "B," place them in the stereo field, or slightly delay the sound of channel "B" to produce a spacious sound. |
| SEND/RETURN | You can connect an external effects processor between the SEND jack and RETURN jack, and use it as one of the GT-100's effects processors. |

| Effect | Explanation |
|----------------|---|
| PEDAL FX | PEDAL FX is an effect used to control WAH or PEDAL BEND with the [EXP] pedal. The SUB EXP pedal cannot be used for this control. |
| FOOT VOLUME | FOOT VOLUME is a volume control effect. Normally, this is controlled with the EXP Pedal or the [EXP] pedal connected to the SUB CTL 1, 2/SUB EXP jack. |
| ACCEL FX | This allows for the use of six different types of Accel effects, which modify the sound over time when you depress the [ACCEL/CTL] pedal. |
| USB | Here you can make USB-related settings for when the GT-100 is connected to a computer via USB. |
| MASTER SETTING | These settings are applied to the overall patch. |

How to obtain a PDF of the Parameter Guide

For a list of all effects' parameters, download "GT-100 Parameter Guide" (PDF file) from "GT-100" in the "Owner's Manuals" list on the Roland website (<http://www.roland.com/support/en/>).

OD/DS Type List

This is a list of distortion types that can be selected for OD/DS.

| Category | Type | Explanation |
|-----------|--|---|
| ADVANCED | MID BOOST | This is a booster with unique characteristics in the midrange. Making the connection before the COSM amp produces sound suitable for solos. |
| | CLEAN BOOST | This not only functions as a booster, but also produces a clean tone that has punch even when used alone. |
| | TREBLE BOOST | This is a booster that has bright characteristics. |
| | CRUNCH | A lustrous crunch sound with an added element of amp distortion. |
| | NATURL OD (NATURAL OD) | This is an overdrive sound that provides distortion with a natural feeling. |
| | WARM OD | This is a warm overdrive. |
| | FAT DS | A distortion sound with thick distortion. |
| | LEAD DS | Produces a distortion sound with both the smoothness of an overdrive along with a deep distortion. |
| | METAL DS | This is distortion sound that is ideal for performances of heavy riffs. |
| | OCT FUZZ | A fuzz sound with rich harmonic content. |
| VINTAGE | BLUES OD | This is a crunch sound of the BOSS BD-2. This produces distortion that faithfully reproduces the nuances of picking. |
| | OD-1 | This models the sound of the BOSS OD-1. This produces sweet, mild distortion. |
| | T-SCREAM | This models an Ibanez TS-808. |
| | TURBO OD | This is the high-gain overdrive sound of the BOSS OD-2. |
| | DIST | This gives a basic, traditional distortion sound. |
| | RAT | This models a Proco RAT. |
| | GUV DS | This models a Marshall GUV' NOR. |
| | DST+ | This models a MXR DISTORTION+. |
| | METAL ZONE | This models the sound of the BOSS MT-2. It produces a wide range of metal sounds, from old style to slash metal. |
| | '60S FUZZ | This models a FUZZFACE. It produces a fat fuzz sound. |
| MUFF FUZZ | This models an Electro-Harmonix Big Muff π. | |
| CUSTOM | Custom OD/DS You can customize it however you like to match the sound you want. | |

Preamp Type List

This is a list of the amp types that can be selected for PREAMP.

| Category | Type | Explanation |
|----------------|---|---|
| ADVANCED | NATURL CLEAN (NATURAL CLEAN) | An unembellished, clean sound that minimizes the amp's idiosyncrasies, such as its trebly character and boomy low end. |
| | FULL RANGE | An amp with a broad frequency range and an extremely flat response. Good for acoustic guitar. |
| | COMBO CRUNCH | Crunch sound that allows the nuances of your picking to be expressed even more faithfully than on conventional combo amps. |
| | STACK CRUNCH | Great-feeling crunch sound that responds well to picking dynamics while retaining all the defining characteristics of a 4 x 12" speaker cabinet. |
| | HiGAIN STACK | High-gain sound of a vintage Marshall specially revamped in a way that is possible only with COSM modeling technology. |
| | POWER DRIVE | A straight drive sound that works well in a broad range of situations, from backing to lead. A sound like this cannot be obtained from any existing combo amp or stack amp. |
| | EXTREM LEAD (EXTREME LEAD) | A new type of sound that smoothes out the uneven frequency response that is typical of existing large stack amps. |
| | CORE METAL | A large stack sound that has been tweaked extensively in the pursuit of the ultimate metal sound. |
| | JC-120 | This models the sound of the Roland JC-120. |
| | CLEAN TWIN | This models a Fender Twin Reverb. |
| PRO CRUNCH | This models a Fender Pro Reverb. | |
| TWEED | This models a Fender Bassman 4 x 10" Combo. | |
| DELUXE CRUNCH | This models a Fender Deluxe Reverb. | |
| VO DRIVE | This models the drive sound of a VOX AC-30TB. This is a sound that it suited to sixties-style British rock. | |
| VO LEAD | This models the lead sound of the VOX AC-30TB. | |
| MATCH DRIVE | This models the sound input to left input on a Matchless D/C-30. A simulation of the latest tube amp widely used in styles from blues and rock. | |
| BG LEAD | This models the lead sound of the MESA/ Boogie combo amp. The sound of a tube amp typical of the late '70s to '80s. | |
| BG DRIVE | This models a MESA/Boogie with TREBLE SHIFT SW on. | |
| MS1959 I | This models the sound input to Input I on a Marshall 1959. This is a trebly sound suited to hard rock. | |
| MS1959 I+II | The sound of connecting inputs I and II of the guitar amp in parallel, creating a sound with a stronger low end than I. | |
| R-FIER VINTAGE | Models the sound of the Channel 2 VINTAGE Mode on the MESA/Boogie DUAL Rectifier. | |

| Category | Type | Explanation |
|----------|---------------|---|
| VINTAGE | R-FIER MODERN | Models the sound of the Channel 2 MODERN Mode on the MESA/Boogie DUAL Rectifier. |
| | T-AMP LEAD | This models a Hughes & Kettner Triamp AMP3. |
| | SLDN | This models a Soldano SLO-100. This is the typical sound of the eighties. |
| | 5150 DRIVE | This models the lead channel of a Peavey EVH 5150. |
| CUSTOM | | This is a custom preamp. You can customize it however you like to match the sound you want. |

FX1/FX2 Effects List

This is a list of the effects that can be selected for FX1/FX2.

| Effect Name | Explanation |
|---|--|
| T. WAH (Touch Wah) | You can produce a wah effect with the filter changing in response to the guitar level. |
| AUTO WAH (Auto Wah) | This changes the filtering over a periodic cycle, providing an automatic wah effect. |
| SUB WAH | You can control the wah effect in real time by adjusting the [EXP] pedal or the expression pedal connected to the SUB CTL 1, 2/SUB EXP jack. |
| ADV. COMP (Advanced Compressor) | This is an effect that produces a long sustain by evening out the volume level of the input signal. You can also use it as a limiter to suppress only the sound peaks and prevent distortion. |
| LIMITER | The limiter attenuates loud input levels to prevent distortion. |
| SUB OD/DS | This effect distorts the sound to create long sustain. It provides 21 types of distortion. For the types of distortion that can be selected for OD/DS, refer to "OD/DS Type List." * "CUSTOM" is not available. |
| GRAPHIC EQ (Graphic Equalizer) | This adjusts the tone as an equalizer. You can adjust the sound quality in ten bands. |
| PARA EQ (Parametric Equalizer) | Adjusts the tonal quality. You can adjust the sound quality in four bands. |
| tone MODIFY | This changes the tone of the connected guitar. |
| GUITAR SIM (Guitar Simulator) | Simulation of the characteristics of particular guitar components such as pickups and different guitar bodies allows you to switch among a number of different guitar types all while using a single guitar. |
| SLOW GEAR | This produces a volume-swell effect ("violin-like" sound). |
| DEFRETTER | This simulates a fretless guitar. |
| WAVE SYNTH | This is a synth sound that processes the guitar input signal. |
| SITAR SIM. (Sitar Simulator) | This simulates the sound of the sitar. |
| OCTAVE | This adds a note one octave lower, creating a richer sound. |
| PITCH SHIFTER | This effect changes the pitch of the original sound (up or down) within a range of two octaves. |
| HARMONIST | Harmonist is an effect where the amount of shifting is adjusted according to an analysis of the guitar input, allowing you to create harmonics based on diatonic scales. |
| SOUND HOLD | You can have sound played on the guitar be held continuously. This effect allows you to perform the melody in the upper registers while holding a note in the lower registers. |

| Effect Name | Explanation |
|--|--|
| AC. PROCESSOR (Acoustic Processor) | This processor allows you to change the sound produced by the pickup on an acoustic electric guitar, creating a richer sound similar to that obtained with a microphone placed close to the guitar. |
| PHASER | By adding varied-phase portions to the direct sound, the phaser effect gives a whooshing, swirling character to the sound. |
| FLANGER | The flanging effect gives a twisting, jet-airplane-like character to the sound. |
| TREMOLO | Tremolo is an effect that creates a cyclic change in volume. |
| ROTARY | This produces an effect like the sound of a rotary speaker. |
| UNI-V | This models a Uni-Vibe. Although this resembles a phaser effect, it also provides a unique undulation that you can't get with a regular phaser. |
| PAN | With the volume level of the left and right sides alternately changing, when playing sound in stereo, you can get an effect that makes the guitar sound appear to fly back and forth between the speakers. |
| SLICER | This consecutively interrupts the sound to create the impression that a rhythm backing phrase is being played. |
| VIBRATO | This effect creates vibrato by slightly modulating the pitch. |
| RING MOD. | This creates a bell-like sound by ring-modulating the guitar sound with the signal from the internal oscillator. The sound can be unmusical and lack distinctive pitches. |
| HUMANIZER | This can create human vowel-like sounds. |
| 2X2 CHORUS | Frequency band division is employed to produce two different choruses, one for low frequencies and one for higher frequencies, for both the left and right channels (for a total of four). This allows you to achieve a more natural chorus sound. |
| SUB DELAY | This is a delay with the maximum delay time of 1,000 ms. This effect is useful for making the sound fatter. |

GT-100 Preset Patch List

| Path # | Patch Name | Explanation | DIVIDER | PREAMP A | PREAMP B | ACCEL/CTL | PU |
|--------|------------------|---|------------------|----------------|----------------|--|-----|
| P01-1 | Hi GAIN STACK | The powerful and fat sound of a high-gain amp stack. Ideal for backing or riffs. | SINGLE: Ch. A | HiGAIN STACK | HiGAIN STACK | DIV CH SELECT, DELAY | H |
| P01-2 | Hi GAIN LEAD | The mid-boost lead sound of a stack amp. The CTL pedal turns SOLO on. | SINGLE: Ch. A | EXTREME LEAD | POWER DRIVE | A&B SOLO | H |
| P01-3 | COMBO CRUNCH | The sound of a combo amp featuring extremely direct and sensitive touch response, with the low-frequency range reduced appropriately. | SINGLE: Ch. A | COMBO CRUNCH | COMBO CRUNCH | DIV CH SELECT | H |
| P01-4 | NATURAL CLEAN | An all-around sound usable for everything from solos to rhythm. With a broad range and good sustain from the high frequencies to the low frequencies. | SINGLE: Ch. A | NATURAL CLEAN | COMBO CRUNCH | DIV CH SELECT | S/H |
| P02-1 | POWER DRIVE | A straightforward and powerful drive sound that lets the character of the guitar come through. | SINGLE: Ch. A | POWER DRIVE | POWER DRIVE | DIV CH SELECT, DELAY | S/H |
| P02-2 | CRUNCH LEAD | A straightforward and powerful drive sound that lets the character of the guitar come through. | SINGLE: Ch. A | COMBO CRUNCH | COMBO CRUNCH | DIV CH SELECT, CHORUS | S/H |
| P02-3 | STACK CRUNCH | Switch between stack crunch sounds with different gain for backing and solo. | SINGLE: Ch. A | STACK CRUNCH | STACK CRUNCH | DIV CH SELECT, DELAY | H |
| P02-4 | TWEED CLEAN | Use the CTL pedal to switch between a tweed amp's clean tone and a mid-boost lead tone. | SINGLE: Ch. A | TWEED | TWEED | DIV CH SELECT | H |
| P03-1 | SINGLE COILROCK | A hard crunch sound, ideal for punchy rhythm playing. The CTL pedal boosts the GAIN and MID. | SINGLE: Ch. A | STACK CRUNCH | STACK CRUNCH | DIV CH SELECT | S |
| P03-2 | BG LEAD | A tube amp sound typical of the late 70s through the 80s. The CTL pedal switches to a lead tone with chorus applied. | SINGLE: Ch. A | BG LEAD | BG LEAD | DIV CH SELECT | S/H |
| P03-3 | ROLLING TONE | A sound with a touch of crunch, ideal for rhythm. The CTL pedal boosts the GAIN and MID. | SINGLE: Ch. A | NATURAL CLEAN | COMBO CRUNCH | DIV CH SELECT | H |
| P03-4 | MixSLICE & ACCEL | Clean sound with the addition of a pitch shifter and slicer. The ACCEL pedal raises the overall pitch. | DUAL | FULL RANGE | NATURAL CLEAN | ACCEL (S-BEND) | H |
| P04-1 | ZEE ZEE POP | Rhythm tone for classic rock. The CTL pedal increases the gain and volume. | SINGLE: Ch. A | POWER DRIVE | POWER DRIVE | DIV CH SELECT, DELAY | S/H |
| P04-2 | HARMONY LEADinAm | Sustaining harmony tone, ideal for fusion solos. | SINGLE: Ch. A | NATURAL CLEAN | COMBO CRUNCH | FX2 (HARMONIST) | S/H |
| P04-3 | VINTAGE OVERDRV | Vintage OD-1 sound. The CTL pedal selects a sound appropriate for solos. | SINGLE: Ch. B | JC-120 | NATURAL CLEAN | OD/DS SOLO, COMP, DELAY | H |
| P04-4 | COMP PedalWAH | Pedal wah sound with compression. The CTL pedal switches to a lead sound. | SINGLE: Ch. A | NATURAL CLEAN | COMBO CRUNCH | DIV CH SELECT | H |
| P05-1 | MODERN METAL | An extremely heavy metal sound, usable for anything from rhythm to lead. | SINGLE: Ch. A | EXTREME LEAD | EXTREME LEAD | DIV CH SELECT, DELAY | S/H |
| P05-2 | OD-1 +STACK | A hard rock sound with phaser and OD-1 applied before the distortion. | SINGLE: Ch. A | STACK CRUNCH | MS1959 I | FX1 (PHASER) | H |
| P05-3 | PedalWAH CRUNCH | Crunch sound with pedal wah. | SINGLE: Ch. A | COMBO CRUNCH | COMBO CRUNCH | DIV CH SELECT | H |
| P05-4 | TIGHT CLEAN | Extremely hard clean tone, ideal for rhythmic muted chording. The CTL pedal applies phaser and chorus. | SINGLE: Ch. A | NATURAL CLEAN | NATURAL CLEAN | DIV CH SELECT | S/H |
| P06-1 | 70s US HARDROCK | A retro hard rock sound from the 70s. | SINGLE: Ch. A | STACK CRUNCH | POWER DRIVE | DIV CH SELECT, DELAY | S |
| P06-2 | CHORUS LEAD | Metal sound with chorus, usable for either backing or lead. | SINGLE: Ch. A | NATURAL CLEAN | NATURAL CLEAN | DIV CH SELECT, OD/DS | S/H |
| P06-3 | JONNY'S BEEN BAD | Classic rock'n'roll tone. The CTL pedal switches to a lead tone. | SINGLE: Ch. A | NATURAL CLEAN | STACK CRUNCH | DIV CH SELECT, DELAY | S/H |
| P06-4 | CLEAN STACK | The sound of an amp stack. The CTL pedal switches between clean and crunch. | SINGLE: Ch. A | STACK CRUNCH | STACK CRUNCH | DIV CH SELECT | S/H |
| P07-1 | DS <-> MTL ZONE | Use the CTL pedal to switch between distortion and Metal Zone. | SINGLE: Ch. A | NATURAL CLEAN | JC-120 | DIV CH SELECT | S/H |
| P07-2 | R-FIER LEAD | Hard distortion sound, ideal for metal riffs. The CTL pedal switches to a lead sound. | SINGLE: Ch. A | R-FIER VINTAGE | R-FIER VINTAGE | DIV CH SELECT | S/H |
| P07-3 | BEE BEE THRILL | Combo amp sound suitable for blues leads. | SINGLE: Ch. A | VO LEAD | COMBO CRUNCH | DIV CH SELECT | H |
| P07-4 | CLEAN SUSTAIN | A clean sound with good sustain. The CTL pedal switches to a stack crunch sound. | SINGLE: Ch. A | NATURAL CLEAN | STACK CRUNCH | DIV CH SELECT | S/H |
| P08-1 | POWER CHORD! | A drive sound, simple yet with presence. | SINGLE: Ch. A | HiGAIN STACK | HiGAIN STACK | DIV CH SELECT, DELAY | H |
| P08-2 | COMBO LEAD | A combo amp lead sound. You can use the ACCEL pedal for feedback performance. | SINGLE: Ch. A | COMBO CRUNCH | COMBO CRUNCH | ACCEL (FEED- BACKER) | S/H |
| P08-3 | JAZZ FIELD | An aggressive jazz tone. The CTL pedal switches to a sound for soloing. | SINGLE: Ch. A | BG LEAD | BG LEAD | DIV CH SELECT, COMP, DELAY, REVERB LEVEL | H |
| P08-4 | E.GTR-> AcGUITAR | Transforms the sound of an electric guitar to the sound of an acoustic guitar. | SINGLE: Ch. A | FULL RANGE | NATURAL CLEAN | DIV CH SELECT, FX1 (GUITAR SIM) | S/H |

| Path # | Patch Name | Explanation | DIVIDER | PREAMP A | PREAMP B | ACCEL/CTL | PU |
|--------|-------------------|--|------------------|---------------|---------------|--|-----|
| P09-1 | METAL MONEY | The metal sound of the 90s. | SINGLE: Ch. A | CORE METAL | CORE METAL | DIV CH SELECT | S/H |
| P09-2 | OVERDRV LEAD | A simple overdrive sound. | SINGLE: Ch. B | NATURAL CLEAN | NATURAL CLEAN | DIV CH SELECT | H |
| P09-3 | TWIN CRUNCH | Crunch sound from a Twin Reverb. | SINGLE: Ch. A | CLEAN TWIN | CLEAN TWIN | REVERB | S |
| P09-4 | BRIGHT RHYTHM | A bright clean sound. The CTL pedal applies chorus. | SINGLE: Ch. A | FULL RANGE | NATURAL CLEAN | DELAY, FX2 (PITCH SHIFTER), REVERB LEVEL | S/H |
| P10-1* | STEREO STACK | The sound of two high-gain amps set up in stereo, suitable for riffing. | DUAL | POWER DRIVE | EXTREME LEAD | DELAY, OD/DS | H |
| P10-2 | FINGER LEAD | Fat sound that still remains sensitive to the nuances of your touch. Ideal for bluesy fusion. | SINGLE: Ch. A | STACK CRUNCH | MS1959 I | OD/DS | S/H |
| P10-3 | TWEED BLUES | Classic blues sound from a tweed amp. | SINGLE: Ch. A | TWEED | NATURAL CLEAN | OD/DS | S/H |
| P10-4 | SUPER CLEAN | Transparently clean sound. Ideal for arpeggios or chording. | SINGLE: Ch. A | FULL RANGE | NATURAL CLEAN | DIV CH SELECT | S/H |
| P11-1 | WALL OF DIST | Power chords produce a wall of distortion. | SINGLE: Ch. A | STACK CRUNCH | BG DRIVE | CHORUS | S |
| P11-2 | WAH LEAD >CRUNCH | The CTL pedal switches between a wah lead from a boosted "TWEED" and a crunch backing sound. | SINGLE: Ch. A | TWEED | DELUXE CRUNCH | PEDAL FX (WAH), OD/DS, DELAY | S |
| P11-3 | DIAMOND ECHO | A clean sound with echo. | DUAL | STACK CRUNCH | STACK CRUNCH | LED ON/OFF, DELAY F.BACK | S |
| P11-4 | SAFARI USA | Tremolo sound suitable for the surf music of the 60s. | SINGLE: Ch. A | TWEED | STACK CRUNCH | DIV CH SELECT | S |
| P12-1* | STEREO HardRiff | A modern hard rock sound appropriate for riffing. | DUAL | POWER DRIVE | EXTREME LEAD | CHORUS | H |
| P12-2 | TUESDAYS LEAD | A sound with phaser lightly applied. | SINGLE: Ch. A | TWEED | TWEED | DIV CH SELECT, FX1 (PHASER), DELAY | H |
| P12-3 | MidRANGE CRUNCH | Crunch sound with a boosted mid-range. | SINGLE: Ch. A | COMBO CRUNCH | COMBO CRUNCH | DIV CH SELECT, DELAY | S/H |
| P12-4 | MILD PHASER | A mild phaser sound. The CTL pedal applies a panning delay. | SINGLE: Ch. A | NATURAL CLEAN | NATURAL CLEAN | DIV CH SELECT | H |
| P13-1 | DIRTY DS&TR CLN | The CTL pedal switches between lo-fi distortion and clean tremolo sound. | SINGLE: Ch. A | COMBO CRUNCH | DELUXE CRUNCH | DIV CH SELECT | H |
| P13-2 | SQUARE LEAD | Distortion sound with extreme sustain. Use the ACCEL pedal to apply pitch bend. | SINGLE: Ch. A | FULL RANGE | COMBO CRUNCH | ACCEL (S-BEND) | S/H |
| P13-3 | DUAL MTL/ CRUNCH | A sound that combines core metal and crunch. | DUAL | COMBO CRUNCH | CORE METAL | FX1 (PITCH SHIFTER), OD/DS, DELAY | H |
| P13-4 | COMP CHORUS | A clean stereo chorus sound. | SINGLE: Ch. A | NATURAL CLEAN | POWER DRIVE | DIV CH SELECT | S/H |
| P14-1 | AMBIENT DIRTY OD | Drive sound with added room ambience. | SINGLE: Ch. A | STACK CRUNCH | MS1959 I | REVERB | H |
| P14-2 | SMOOTH LEAD | Classic lead tone for rock, also ideal for sweep-picking. | SINGLE: Ch. A | 5150 DRIVE | T-AMP LEAD | DIV CH SELECT | H |
| P14-3 | ATTACKY CRUNCH | A crunch sound with a sense of attack. The CTL pedal applies mid boost. | DUAL | COMBO CRUNCH | COMBO CRUNCH | OD/DS, DELAY | H |
| P14-4 | CLEAN ROTARY | A clean sound with a rotary effect applied. The CTL pedal switches between fast and slow. | SINGLE: Ch. B | NATURAL CLEAN | NATURAL CLEAN | DIV CH SELECT, FX2 (ROTARY) SPEED SELECT | S/H |
| P15-1 | METAL FLANGER | Metal sound with flanger applied. | SINGLE: Ch. A | NATURAL CLEAN | NATURAL CLEAN | DIV CH SELECT, DELAY | S/H |
| P15-2 | MATCH LEAD | An extremely smooth lead tone. Ideal for fusion solos. | SINGLE: Ch. A | MATCH DRIVE | MATCH DRIVE | DIV CH SELECT | H |
| P15-3 | LIMITED CRUNCH | A crunch tone that will sound smooth and refined when playing chords. | SINGLE: Ch. A | COMBO CRUNCH | MATCH DRIVE | DIV CH SELECT | H |
| P15-4 | FAT COMP CLEAN | A clean sound with boosted mid-range and compressor applied. The CTL pedal applies chorus. | SINGLE: Ch. A | JC-120 | — | CHORUS | S |
| P16-1 | Hi:BG LD Lo:1959 | With both an edgy low range as well as good sustain in the mid and high ranges, this sound can be used for riffing and lead without switching. | DUAL | BG LEAD | MS1959 I | OD/DS, DELAY | H |
| P16-2 | FUSION 335 | A lead tone of 70s fusion. The CTL pedal boosts the gain and volume. | SINGLE: Ch. A | NATURAL CLEAN | DELUXE CRUNCH | DIV CH SELECT | H |
| P16-3 | 80s JAZZ FUSION | A fusion lead tone using stereo chorus. | SINGLE: Ch. A | NATURAL CLEAN | JC-120 | OD/DS | H |
| P16-4 | MILD JAZZTONE | Used with humbuckers, this produces a mild jazz tone. Also suitable for finger-picking. | SINGLE: Ch. A | NATURAL CLEAN | NATURAL CLEAN | DIV CH SELECT | H |
| P17-1 | BOSSTONE DRV-SOLO | One of the rock sounds of the late 70s. The CTL pedal switches to a sound for soloing. | SINGLE: Ch. A | NATURAL CLEAN | NATURAL CLEAN | DIV CH SELECT | S/H |
| P17-2 | MidBOOST COMBO | The crunch sound of a mid-boosted combo amp. | SINGLE: Ch. A | COMBO CRUNCH | MS1959 I | DELAY | S/H |

Appendices

| Path # | Patch Name | Explanation | DIVIDER | PREAMP A | PREAMP B | ACCEL/CTL | PU |
|--------|-------------------|---|------------------|---------------|----------------|---------------------------------|-----|
| P17-3 | COUNTRY PICKIN' | A classic country rock sound. | SINGLE: Ch. A | CLEAN TWIN | – | OD/DS | S |
| P17-4 | DLY TIME TAP CTL | Clean sound with a delay that can be synchronized to the rhythm by tapping. | SINGLE: Ch. A | NATURAL CLEAN | JC-120 | DELAY TAP | H |
| P18-1 | LATE 80s HdRockRf | Suitable for simple hard rock. The CTL pedal turns the SOLO switch on. | SINGLE: Ch. A | MS1959 I | COMBO CRUNCH | A/B SOLO | H |
| P18-2 | ITS JUST A PHASE | Phaser sound, ideal for 70s rock riffs. The CTL pedal boosts the gain and volume. | SINGLE: Ch. A | MS1959 I+II | MS1959 I+II | DIV CH SELECT, DELAY | H |
| P18-3 | LOOSE ROPE | A lead tone for modern country. | SINGLE: Ch. A | DELUXE CRUNCH | – | OD/DS | S |
| P18-4 | FUNKY GT FOR HumB | Sound that won't distort even when playing through humbuckers. Also suitable for clean muted chords. | SINGLE: Ch. A | NATURAL CLEAN | NATURAL CLEAN | CHORUS, COMP | H |
| P19-1 | LATE 80s METAL RF | Slash metal sound of the 80s. The CTL pedal switches to JC Clean. | SINGLE: Ch. B | JC-120 | CORE METAL | DIV CH SELECT | H |
| P19-2 | ROADS | Sound with delay applied, ideal for leads in 70s rock. | SINGLE: Ch. B | NATURAL CLEAN | CORE METAL | DIV CH SELECT | H |
| P19-3 | BLACK PANEL | Vintage clean sound. The CTL pedal applies mid-boost. | SINGLE: Ch. A | CLEAN TWIN | – | OD/DS | S |
| P19-4 | NORWEGIN GROVE | Sound that adds the distinctive buzz drone of a sitar. | SINGLE: Ch. A | FULL RANGE | NATURAL CLEAN | DIV CH SELECT, DELAY, CHORUS | H |
| P20-1 | Hi:JC120 Lo:STACK | The low range is assigned to a high-gain stack, and the mid and high ranges to a JC-120. | DUAL | JC-120 | HIGAIN STACK | DELAY | S/H |
| P20-2 | FRANKLY SWEEPING | The fusion rhythm tone of the 90s. The CTL pedal boosts the gain and volume for soloing. | SINGLE: Ch. A | POWER DRIVE | POWER DRIVE | DIV CH SELECT | H |
| P20-3 | FUSION Y | Fusion lead tone with pan delay. | SINGLE: Ch. A | SLDN | SLDN | DIV CH SELECT | H |
| P20-4 | NATURAL JAZZTONE | Sweet and tight jazz sound. | SINGLE: Ch. A | NATURAL CLEAN | NATURAL CLEAN | DIV CH SELECT | H |
| P21-1* | DUAL MIC StereoMS | Stereo sound produced by a two-mic setup. | DUAL | MS1959 I | MS1959 I | A&B SOLO | H |
| P21-2 | MELLOW LEAD | Bluesy sound with warm overdrive. | SINGLE: Ch. A | NATURAL CLEAN | JC-120 | DIV CH SELECT | H |
| P21-3 | BASIC BLUES | Crunch sound with compressor, ideal for blues or classic rock. | SINGLE: Ch. A | COMBO CRUNCH | COMBO CRUNCH | DIV CH SELECT | H |
| P21-4 | DEEP CS StCHORUS | A rich sound that uses a combination of several modulation-type effects. | SINGLE: Ch. A | NATURAL CLEAN | HIGAIN STACK | DIV CH SELECT | S/H |
| P22-1* | DUAL ST Hi GAIN | Stereo high-gain sound produced by two amps. | DUAL | T-AMP LEAD | R-FIER VINTAGE | CHORUS | H |
| P22-2 | OUT DELAY | Lead tone using a long stereo delay. | SINGLE: Ch. A | R-FIER MODERN | COMBO CRUNCH | FX2 (SUB DELAY) | S/H |
| P22-3 | T-SCREAM TWEED | Tweed amp sound notable for its mellow tube distortion. | SINGLE: Ch. A | TWEED | – | FX1 (SUB OD/DS), DELAY | S/H |
| P22-4 | ELCTRIC PIANO | Clean sound of the 70s with a soft phaser. | SINGLE: Ch. A | NATURAL CLEAN | – | FX2 (PAN) | S |
| P23-1 | FAT DRY MIX MS | Crisp and bold drive sound. | SINGLE: Ch. A | MS1959 I+II | STACK CRUNCH | A&B SOLO | H |
| P23-2 | ROYAL LEAD | British lead tone of the 70s and 80s. | SINGLE: Ch. A | VO LEAD | COMBO CRUNCH | DELAY | H |
| P23-3 | TIGHT CRUNCH | A tight combo crunch sound. | SINGLE: Ch. A | COMBO CRUNCH | COMBO CRUNCH | DIV CH SELECT, DELAY, CHORUS | H |
| P23-4 | REGGIE | The sound of 70s funk. The CTL pedal boosts the gain. | SINGLE: Ch. A | NATURAL CLEAN | NATURAL CLEAN | DIV CH SELECT | S |
| P24-1 | METAL ACOUSTIC | A sound that combines metal and acoustic. | DUAL | FULL RANGE | CORE METAL | CHORUS, DELAY | S |
| P24-2 | FEEDBACK CONTROL | Pressing the ACCEL pedal allows you to perform feedback with the sound of a high-gain tube amp. | SINGLE: Ch. A | SLDN | EXTREME LEAD | ACCEL (FEED- BACKER) | S/H |
| P24-3 | 70s BRITROCK | An early British stack tone that's ideal for leads. | SINGLE: Ch. A | PRO CRUNCH | COMBO CRUNCH | DIV CH SELECT | H |
| P24-4 | CHORDS SO SWEET | Clean tone with beautiful stereo panning. The CTL pedal adds a touch of crunch. | SINGLE: Ch. A | NATURAL CLEAN | HIGAIN STACK | DIV CH SELECT | S |
| P25-1 | BARK TONE | 70s rock sound with phaser. The CTL pedal makes the sound suitable for leads and also turns on a delay. | SINGLE: Ch. A | CORE METAL | CORE METAL | DIV CH SELECT, DELAY | H |
| P25-2 | LEAD DREAMER | A high-gain lead with auto wah applied. The ACCEL pedal produces a unique sound using S.Bend. | SINGLE: Ch. A | 5150 DRIVE | – | ACCEL (S-BEND) | H |
| P25-3 | 1959 CRUNCH | Crunch sound based on MS1959. | SINGLE: Ch. A | MS1959 I | – | OD/DS, DELAY | H |
| P25-4 | CLEAN MACHINE | Crystal-clean sound. Ideal for rhythm in styles such as country. | SINGLE: Ch. A | JC-120 | COMBO CRUNCH | DIV CH SELECT | S |
| P26-1 | REIGN IN THRASH | Slash metal sound of the 80s. Ideal for riffing. | SINGLE: Ch. A | SLDN | SLDN | DIV CH SELECT, DELAY | H |
| P26-2 | 1969 XPERIENC | Psychedelic rock sound of the 1969 Woodstock festival. Intense distortion produced using fuzz. | DUAL | TWEED | EXTREME LEAD | ACCEL (S-BEND) | S |

| Path # | Patch Name | Explanation | DIVIDER | PREAMP A | PREAMP B | ACCEL/CTL | PU |
|--------|-------------------|---|---------------|---------------|----------------|---------------------------------------|-----|
| P26-3 | CRUNCH DELAY | American crunch sound with chorus and delay applied. Also suitable for country styles. | SINGLE: Ch. A | COMBO CRUNCH | COMBO CRUNCH | DIV CH SELECT | S |
| P26-4 | FUNKY DELICK | A sound that's ideal for 16-beat muted chording in funk or fusion | SINGLE: Ch. A | DELUXE CRUNCH | EXTREME LEAD | DIV CH SELECT | S/H |
| P27-1 | CHAINED UP | A riff tone used in classic rock. The CTL pedal adds a flanger. | SINGLE: Ch. A | 5150 DRIVE | 5150 DRIVE | DIV CH SELECT, FX1 (FLANGER) | S/H |
| P27-2 | MAHOGANY FLASHBAC | A wide-ranged lead tone of the late 70s. | DUAL | TWEED | EXTREME LEAD | ACCEL (S-BEND) | S/H |
| P27-3 | PLEXI RHYTHM | A rhythm tone used in classic rock. | SINGLE: Ch. A | PRO CRUNCH | STACK CRUNCH | DIV CH SELECT, DELAY | H |
| P27-4 | LEAD PICKIN' | Vintage country lead sound. | SINGLE: Ch. A | CLEAN TWIN | CLEAN TWIN | DIV CH SELECT | S |
| P28-1 | BLUES BUDDY | Crunch rhythm sound for blues. The CTL pedal switches to a lead sound. | SINGLE: Ch. A | CLEAN TWIN | CLEAN TWIN | DIV CH SELECT | S/H |
| P28-2 | MONEY StillWah | A lead tone with a muffled sound. Turn the EXP SW on to use pedal wah. | SINGLE: Ch. A | POWER DRIVE | EXTREME LEAD | DIV CH SELECT | S/H |
| P28-3 | KING OF BLUES | A sound that's ideal for blues leads. | SINGLE: Ch. A | DELUXE CRUNCH | - | FX2 (SUB DELAY) | S |
| P28-4 | SPINNER | A clean rotary sound. | SINGLE: Ch. A | NATURAL CLEAN | COMBO CRUNCH | DIV CH SELECT | S/H |
| P29-1 | LOVE SUMMER | A sound used by fusion players of recent years. | SINGLE: Ch. B | NATURAL CLEAN | NATURAL CLEAN | DIV CH SELECT | H |
| P29-2 | 1984 DRIVIN' | Drive sound reminiscent of 80s hard rock. | SINGLE: Ch. A | HIGAIN STACK | 5150 DRIVE | DIV CH SELECT | H |
| P29-3* | ROUGH'N' DIRTY | Dirty rock sound. Ideal for backing or riffs. | DUAL | POWER DRIVE | R-FIER VINTAGE | ACCEL (S-BEND), DELAY LEVEL | S/H |
| P29-4 | CLN TWIN SOUTHERN | Clean sound that's great for country rock riffs. | SINGLE: Ch. A | CLEAN TWIN | DELUXE CRUNCH | DIV CH SELECT | S |
| P30-1 | METAL CORN | The ideal sound for heavy metal riffing. The CTL pedal boosts the gain and volume. | SINGLE: Ch. A | R-FIER MODERN | CORE METAL | DIV CH SELECT | H |
| P30-2 | CREAMY SET | A bluesy sound of the late 60s that combines MS1959 with FUZZ. | SINGLE: Ch. A | MS1959 I | STACK CRUNCH | OD/DS | H |
| P30-3 | T.WAH TWEED | The sound of a tweed amp with touch wah. | SINGLE: Ch. A | TWEED | TWEED | DIV CH SELECT | S/H |
| P30-4 | COMP CLEAN | A clean sound with compression. Ideal for rhythm or riffs. | SINGLE: Ch. A | NATURAL CLEAN | COMBO CRUNCH | DIV CH SELECT | S |
| P31-1 | STACK LEAD | A stack amp sound with sustained distortion. Suitable for both backing and soloing. | SINGLE: Ch. A | POWER DRIVE | EXTREME LEAD | DIV CH SELECT, DELAY | S/H |
| P31-2 | 70s T.WAH LD | A lead sound of the 70s using touch wah. | SINGLE: Ch. A | STACK CRUNCH | MS1959 I | FX1 (T. WAH) | H |
| P31-3 | DirtyOle TWEED | The sound of a small combo amp with a bit of overdrive. Great for blues or funk. | DUAL | TWEED | PRO CRUNCH | ACCEL (S-BEND) | S |
| P31-4 | MinneapolisFNK | An extremely clean sound, ideal for rhythm chording. | DUAL | - | - | CHORUS | S |
| P32-1 | TWEED BLUES 2 | The classic sound of Texas blues. | SINGLE: Ch. A | TWEED | NATURAL CLEAN | OD/DS | S |
| P32-2 | NY LEAD MODULATE | A lead sound with a strongly modulated flanger. Also usable for cool jazz fusion. | SINGLE: Ch. A | BG DRIVE | JC-120 | DIV CH SELECT, OD/DS | H |
| P32-3 | SQUEEZE BLUES GT | A bluesy sound with ambience included. | SINGLE: Ch. B | TWEED | CLEAN TWIN | OD/DS | H |
| P32-4 | TOUCH WAH CLN | Strongly modulated chorus and touch-wah. Good for arpeggios. | SINGLE: Ch. A | NATURAL CLEAN | JC-120 | FX1 (T. WAH) | H |
| P33-1 | BLADE METAL | An extremely sharp metal tone. | SINGLE: Ch. A | R-FIER MODERN | - | OD/DS | H |
| P33-2 | PROGRESS SmoothLD | Use the CTL pedal to switch between a lead tone with a soft attack and a clean tone with a gorgeous chorus. | SINGLE: Ch. A | BG LEAD | COMBO CRUNCH | DIV CH SELECT | H |
| P33-3 | CRUNCH FLANGER | A cool flanger sound suitable for arpeggios. | SINGLE: Ch. A | COMBO CRUNCH | NATURAL CLEAN | DIV CH SELECT | S/H |
| P33-4* | JS SIG. CLEAN | A clean sound for guitar instrumentals of the 80s. | DUAL | BG DRIVE | NATURAL CLEAN | ACCEL (S-BEND) | S |
| P34-1 | GREAT ROCK | A hard rock tone used in the 80s and 90s. | SINGLE: Ch. A | MS1959 I | HIGAIN STACK | DIV CH SELECT | S/H |
| P34-2 | SLIDE FOR ST | Ideal sound for playing slide guitar with single coil pickups. | SINGLE: Ch. A | TWEED | TWEED | DIV CH SELECT | S |
| P34-3 | ROTARY CRUNCH | Standard rotary sound for rock. | SINGLE: Ch. A | STACK CRUNCH | - | LED ON/OFF, FX2 (ROTARY) SPEED SELECT | S |
| P34-4 | FULLERTN DRIVE | Light American crunch sound of the late 50s. | DUAL | PRO CRUNCH | TWEED | CHORUS | S |
| P35-1 | DRAGON METAL | Ideal modern metal sound for humbucking pickups. | SINGLE: Ch. A | T-AMP LEAD | EXTREME LEAD | DIV CH SELECT | H |
| P35-2 | SLIDE FOR LP | Ideal sound for playing slide guitar with humbucking pickups. | SINGLE: Ch. A | PRO CRUNCH | PRO CRUNCH | DIV CH SELECT | H |

Appendices

| Path # | Patch Name | Explanation | DIVIDER | PREAMP A | PREAMP B | ACCEL/CTL | PU |
|--------|-------------------|--|------------------|----------------|----------------|--------------------------------------|-----|
| P35-3 | 70sSMALL AMP | The drive sound produced by a small amp of the 70s. | SINGLE: Ch. A | DELUXE CRUNCH | COMBO CRUNCH | DIV CH SELECT | S |
| P35-4 | BUTTERSCOT.CRN | This sound adds a nice amount of distortion to an ideal rhythm tone. | DUAL | PRO CRUNCH | MS1959 I+II | CHORUS | S |
| P36-1 | HARD RK FLANGE | The flanger sound of 80s metal. | SINGLE: Ch. A | 5150 DRIVE | R-FIER MODERN | DIV CH SELECT | S/H |
| P36-2 | MID 70s S.O.S. | Enjoy sound-on-sound with a two-beat delay. | SINGLE: Ch. A | VO LEAD | COMBO CRUNCH | BPM TAP | S |
| P36-3 | MS DRY CRUNCH | Bold crunch sound suitable for humbucking pickups. | SINGLE: Ch. A | MS1959 I | STACK CRUNCH | OD/DS | H |
| P36-4 | UNMATCHD COMBO | The sound of a fat and extremely clean combo amp. | DUAL | MATCH DRIVE | COMBO CRUNCH | CHORUS | S |
| P37-1 | VAN FLANGE | The flanger sound of 80s hard rock. | SINGLE: Ch. A | R-FIER MODERN | – | ACCEL (S-BEND), DELAY | S/H |
| P37-2 | VIBRATO LEAD | Use the CTL pedal to apply arm-style vibrato. | SINGLE: Ch. A | STACK CRUNCH | COMBO CRUNCH | LED ON/OFF, FX1 (VIBRATO) TRIGGER | S |
| P37-3* | STEREO RIFF | Stereo amp sound appropriate for heavy riffs. | DUAL | POWER DRIVE | HIGAIN STACK | CHORUS | H |
| P37-4* | GREAT WideOpen | Clean sound with stereo panning that creates the impression of a broad horizon. | DUAL | TWEED | VO LEAD | ACCEL (S-BEND) | S |
| P38-1 | RECTOSARIUS | A modern rock sound. | SINGLE: Ch. A | R-FIER VINTAGE | R-FIER MODERN | DIV CH SELECT, DELAY | S/H |
| P38-2 | Hi GAIN LEAD 2 | A smooth high-gain lead sound. Fat distortion can be obtained even with single coil pickups. | SINGLE: Ch. A | EXTREME LEAD | POWER DRIVE | A/B SOLO | S/H |
| P38-3 | COLLEGE ROCK | Crunch sound suitable for chordal riffs. | SINGLE: Ch. A | COMBO CRUNCH | MATCH DRIVE | DIV CH SELECT | S |
| P38-4 | TheULTRA CLEAN | English clean tone with chorus and deep reverb. Appropriate for 80s pop. | SINGLE: Ch. A | FULL RANGE | JC-120 | DIV CH SELECT | S/H |
| P39-1 | UFOBJECT | The classic sound of 70s hard rock. | SINGLE: Ch. A | MS1959 I+II | HIGAIN STACK | DIV CH SELECT, DELAY | H |
| P39-2 | HARMONY LEADinEm | Sound appropriate for melodious metal leads. | SINGLE: Ch. A | NATURAL CLEAN | COMBO CRUNCH | FX2 (HARMONIST) | H |
| P39-3 | AG +CRUNCH | Sound appropriate for melodious metal leads. | DUAL | FULL RANGE | COMBO CRUNCH | LED ON/OFF, PREAMP B MIC LEVEL | S |
| P39-4 | SUPER MODULATE | Clean sound with modulation applied. Also effective when used in the intro. | DUAL | NATURAL CLEAN | NATURAL CLEAN | OD/DS | H |
| P40-1 | RIPPIN' | Fantasy-like sound with deep delay. The ACCEL pedal applies ring modulator. | SINGLE: Ch. A | EXTREME LEAD | – | ACCEL (RING MOD) | H |
| P40-2 | OCTAFUZZ LEAD | A fuzz sound with a unique character. Also useable even if the volume of your guitar is lowered. | SINGLE: Ch. A | CLEAN TWIN | COMBO CRUNCH | FX2 (UNI-V) | S |
| P40-3 | TapDELAY STEREO | Stereo pan delay. You can tap the CTL pedal to set the delay time. | SINGLE: Ch. A | COMBO CRUNCH | NATURAL CLEAN | DELAY TAP | S |
| P40-4 | PH FOR RHYTHM | A light phaser sound that's ideal for muted chords. | SINGLE: Ch. A | CLEAN TWIN | PRO CRUNCH | FX2 (PAN), CHORUS | S |
| P41-1* | PASADENA PLEXI | The hard rock sound of the late 70s. Phaser and delay are applied to a fat British overdrive. | DUAL | STACK CRUNCH | HIGAIN STACK | ACCEL (S-BEND) | S/H |
| P41-2 | Hi GAIN +CRUNCH | A sound that combines a high-gain amp and a combo amp. | DUAL | COMBO CRUNCH | EXTREME LEAD | DELAY | H |
| P41-3 | UK COMBO ForCHORD | A deeply distorted combo amp sound, suitable for playing chords. | SINGLE: Ch. A | VO LEAD | COMBO CRUNCH | DIV CH SELECT | H |
| P41-4 | SLOWGEAR ECHO | A pleasant echo sound using Slow Gear. The CTL pedal applies distortion. | DUAL | NATURAL CLEAN | NATURAL CLEAN | OD/DS | S/H |
| P42-1 | 60s FUZZ LEGEND | Reproduces the combination of a late 60s fuzz and distorted amp. | SINGLE: Ch. A | STACK CRUNCH | COMBO CRUNCH | OD/DS | S |
| P42-2 | MidBOOST STACK | The sound of a mid-boosted stack amp. The ACCEL pedal allows feedback performance. | SINGLE: Ch. A | MS1959 I | COMBO CRUNCH | ACCEL (FEED- BACKER) | S/H |
| P42-3 | 70s PUB ROCK | Produces a sharp sound when used with single coil pickups. | SINGLE: Ch. A | DELUXE CRUNCH | COMBO CRUNCH | DIV CH SELECT | S |
| P42-4 | DEEP DEFRETER | Produces a sound reminiscent of a fretless guitar. Suitable for playing single notes. | SINGLE: Ch. A | NATURAL CLEAN | JC-120 | FX2 (SUB DELAY) | S |
| P43-1 | CALIFORNIA! | American sound of the 70s with compressor and phaser. | SINGLE: Ch. A | DELUXE CRUNCH | – | DIV CH SELECT | S |
| P43-2 | JP LEAD SCOTTISH | A big fat lead sound. | DUAL | R-FIER MODERN | HIGAIN STACK | ACCEL (S-BEND) | S/H |
| P43-3 | ROCKABIL50s ECHO | Reproduces the sound of the 50s with a tape echo and spring reverb. | SINGLE: Ch. A | COMBO CRUNCH | COMBO CRUNCH | DIV CH SELECT | S |
| P43-4 | RESO PH CLEAN | A clean phaser sound with the resonance turned up. | SINGLE: Ch. A | NATURAL CLEAN | JC-120 | FX1 (PAN) | S |
| P44-1 | SHRED FZ | A fuzz sound with a rich overtone structure. Ideal for backing or for solos. | SINGLE: Ch. A | COMBO CRUNCH | VO DRIVE | DELAY | H |
| P44-2 | JP METAL UNISON | Produces a unison sound with one octave below. Ideal for riffs or single notes. | DUAL | 5150 DRIVE | R-FIER VINTAGE | ACCEL (S-BEND) | S/H |

| Path # | Patch Name | Explanation | DIVIDER | PREAMP A | PREAMP B | ACCEL/CTL | PU |
|--------|------------------|---|---------------|---------------|----------------|---|-----|
| P44-3 | NATURAL OVER-DRV | Drive sound ideal for rock'n'roll. The CTL pedal switches to a dry sound. | SINGLE: Ch. A | TWEED | COMBO CRUNCH | OD/DS, DELAY | S |
| P44-4 | VIBRATO CLEAN | Clean sound with an enjoyably wavering tape echo. Use the CTL pedal to add vibrato. | SINGLE: Ch. A | NATURAL CLEAN | JC-120 | LED ON/OFF, FX1 (VIBRATO) TRIGGER | S/H |
| P45-1* | LA TR RIFF | Straight sound and tremolo sound are generated in stereo. | DUAL | COMBO CRUNCH | COMBO CRUNCH | CHORUS | H |
| P45-2 | PedalBND LEAD | This lets you play leads that make effective use of pedal bend pitch change. | SINGLE: Ch. A | POWER DRIVE | COMBO CRUNCH | ACCEL (S-BEND) | H |
| P45-3 | MODERN VO DRIVE | Play chords to get sparkling crunch sound. | SINGLE: Ch. A | VO DRIVE | VO LEAD | DIV CH SELECT | S |
| P45-4 | NEW OLESFUNK | Ideal for funky muted chording of the American South. | SINGLE: Ch. A | CLEAN TWIN | NATURAL CLEAN | CHORUS | S |
| P46-1 | 80s HARDROCK | Rock sound of the 80s using a stereo chorus. | SINGLE: Ch. A | BG LEAD | BG DRIVE | A/B SOLO, DELAY | H |
| P46-2 | SLOWGEAR LEAD | A smooth lead sound using Slow Gear. Also effective on sound-effect phrases. | SINGLE: Ch. A | NATURAL CLEAN | COMBO CRUNCH | FX1 (SLOW GEAR), FX2 (SUB DELAY) | S |
| P46-3 | SLOW AUTO PAN | Produces a slow auto-pan effect. The CTL pedal continuously changes the rate. | SINGLE: Ch. A | COMBO CRUNCH | NATURAL CLEAN | FX2 (PAN) RATE | S |
| P46-4 | UK COMBO CLEAN | The clean sound of a combo amp. The CTL pedal switches to a lead sound. | SINGLE: Ch. A | VO DRIVE | VO LEAD | DIV CH SELECT | S/H |
| P47-1 | 80s NEW WAVE | 80s sound that combines a doubling delay with a chorus. | SINGLE: Ch. A | COMBO CRUNCH | JC-120 | OD/DS | S |
| P47-2 | WAVE SYNTH | Transforms a guitar sound into a synth sound. Use with single notes. | SINGLE: Ch. A | FULL RANGE | COMBO CRUNCH | ACCEL (S-BEND) | S/H |
| P47-3 | CRNCH 4 RHYTHM | Crunch sound for funky rock. Suitable for use with the rear single coil pickup. | SINGLE: Ch. A | COMBO CRUNCH | MS1959 I | FX1 (T. WAH) | S |
| P47-4 | PIEZO-> AcGUITAR | Transforms sound from a piezo pickup into acoustic sound. | SINGLE: Ch. A | FULL RANGE | NATURAL CLEAN | CHORUS, FX1 (GUITAR SIM) | P |
| P48-1 | LATIN ROCK | Combines a sweet lead sound using stereo delay with a rotary clean sound. | SINGLE: Ch. A | BG DRIVE | STACK CRUNCH | DIV CH SELECT | H |
| P48-2 | REVERSE HARMONY | Distorted lead sound with harmony added by effective use of reverse delay. | DUAL | EXTREME LEAD | EXTREME LEAD | ACCEL (S-BEND) | H |
| P48-3 | D'CLEAN DIRT | Sound that combines clean and overdrive. A nice fit with alternative rock. | DUAL | STACK CRUNCH | JC-120 | ACCEL (S-BEND) | S/H |
| P48-4 | E SITAR SIMULATE | A sound reminiscent of an electric sitar. Usable with single notes or chords. | SINGLE: Ch. A | NATURAL CLEAN | COMBO CRUNCH | DELAY | H |
| P49-1* | STEREO R-FIER | A high-gain stereo sound suitable for low-pitched riffing. | DUAL | R-FIER MODERN | R-FIER VINTAGE | DELAY | H |
| P49-2 | ACCEL RING MOD | Press the ACCEL pedal to produce a metallic sound. | SINGLE: Ch. A | NATURAL CLEAN | - | ACCEL (RING MOD), DELAY LEVEL, REVERB LEVEL | S/H |
| P49-3 | PH CRNCH>DS CHOD | A lightly phased crunch sound is combined with intense distortion. | SINGLE: Ch. A | COMBO CRUNCH | STACK CRUNCH | DIV CH SELECT | S |
| P49-4 | ACCEL TWIST | Press the ACCEL pedal to produce a fantasy-like sound. | SINGLE: Ch. A | NATURAL CLEAN | - | ACCEL (TWIST), REVERB LEVEL | S/H |
| P50-1 | METAL GtwithBASS | Core metal sound that adds a suitable bass tone to your riffs. | DUAL | CORE METAL | - | DELAY, COMP LEVEL, PREAMP A SOLO | S/H |
| P50-2 | ACCEL LSR BEAM | Press the ACCEL pedal to generate a sound reminiscent of a laser beam. | SINGLE: Ch. A | BG LEAD | BG LEAD | ACCEL (LASER BEAM), DELAY LEVEL, REVERB LEVEL | S/H |
| P50-3 | MATCH CRUNCH | Crunch sound ideal for use with the rear single coil pickup. | SINGLE: Ch. A | MATCH DRIVE | COMBO CRUNCH | OD/DS, EQ, DELAY | S |
| P50-4 | ACCEL WARP | Press the ACCEL pedal to produce a fantasy-like sound. | SINGLE: Ch. A | NATURAL CLEAN | - | ACCEL (WARP), REVERB LEVEL, DELAY LEVEL | S/H |

* Patches with an "*" following the patch number have their mixer (p. 28) mode set to PAN L/R. For other patches, the mode is set to STEREO.

* DIVIDER = Divider setting (p. 27)

- SINGLE: Ch. A = Divider MODE is SINGLE and CH SELECT is CH. A
- SINGLE: Ch. B = Divider MODE is SINGLE and CH SELECT is CH. B
- DUAL = Divider MODE is DUAL

* PU=Pickup

- S=This patch is good for single-coil pickups.
- H=This patch is good for humbucking pickups.
- P=This patch is good for piezo pickups.

Signal Flow

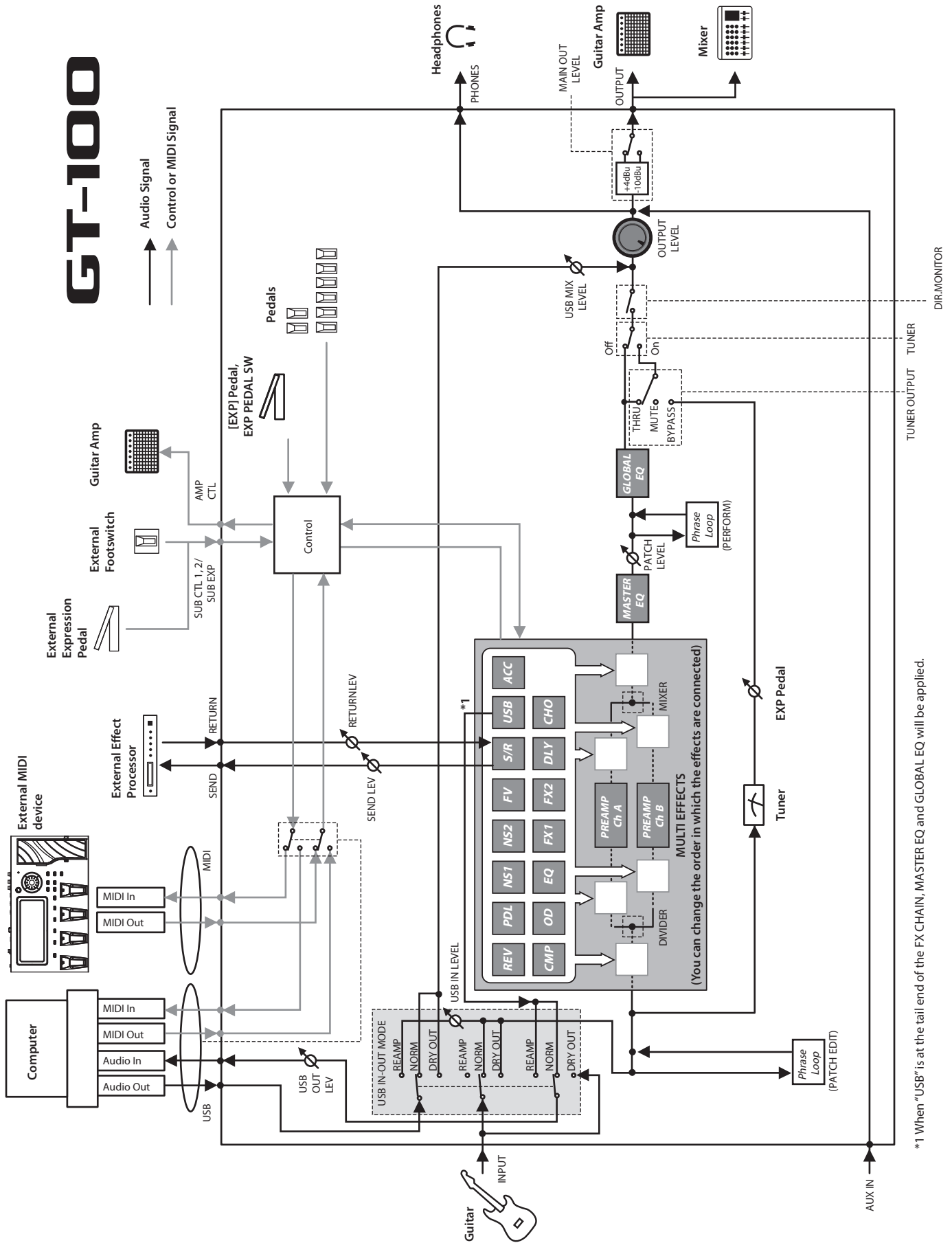

Troubleshooting

| Problem | Items to check | Action |
|--|---|--|
| Problems with the sound | | |
| No sound / volume too low | Are the connection cables broken? | Try using a different set of connection cables. |
| | Is the GT-100 correctly connected to the other devices? | Check connections with the other devices (p. 22). |
| | Is the connected amp/mixer turned off, or the volume lowered? | Check the settings of your amp/mixer system. |
| | Is the [OUTPUT LEVEL] knobs lowered? | Adjust the OUTPUT LEVEL knobs to an appropriate position (p. 24). |
| | Is Tuner set to On? | When the OUTPUT is set to "MUTE" in the Tuner mode, even the direct sound will not be output by setting the Tuner to "On" (p. 24). |
| | Is each effect set correctly? | Check the settings of each effect. |
| | "USB/OUTPUT LEVEL" (p. 43) set to a low value? | Adjust the setting to an appropriate value. |
| | Is "FOOT VOLUME: LEVEL" or "MASTER: PATCH LEVEL" specified as an assign Target (p. 37)? | Move the controller (pedal) to which it is assigned. |
| | Is the power to the external device connected to the EXT LOOP jack off, or is the volume of the device turned down? | Check the settings for the connected device. |
| Sound from devices connected to the INPUT jack is not heard in the headphones | Is the "DIR.MONITOR" (p. 44) set to OFF? | Set to ON. |
| | Is the "USB IN-OUT MODE" (p. 43) set to "REAMP"? | Choose a setting other than "REAMP." |
| The volume level of the instrument connected to INPUT, AUX IN, and RETURN jacks are too low | Could you be using a connection cable that contains a resistor? | Use a connection cable that does not contain a resistor. |
| Oscillating sound occurs | Is the value for any gain- or volume-related effects parameter set too high? | Lower these values. |
| | Is the "USB IN-OUT MODE" (p. 43) set to "REAMP"? | Depending on the software settings, audio signals may end up looping. You can use the following methods to prevent this from happening. <ul style="list-style-type: none"> • Stop playback with the software, and set Soft Thru to Off. • Switch the software's audio input off. • Set USB IN-OUT MODE to something other than "REAMP." |
| No change in preamp tone even after switching patches | Could the preamp "PREFERENCE" (p. 41) be set to "SYSTEM 1-3"? | If PREFERENCE: PREAMP is set to "SYSTEM 1-3," the preamp settings won't change when you switch patches. If you want to make preamp settings individually for each patch, set the above setting to "PATCH." |
| Unable to change parameters with the knobs | Is "INT PEDAL" or "WAVE PEDAL" set as the Assign Source in Assign (p. 37)? | When the Assign Source is set to "INT PEDAL" or "WAVE PEDAL," the effect parameter set as the Assign Target changes automatically. If you want to be able to change the parameters manually with the knobs, first switch off Assign to deactivate the Internal Pedal System. |
| | Is "INPUT LEVEL" set as the Assign Source in Assign (p. 37)? | When "INPUT LEVEL" is set for the Assign Source, the effect parameter set as the Assign Target changes automatically according to the level of the input from the guitar (the playing dynamics). If you want to be able to change the parameters manually with the knobs and dial, first switch off Assign. |
| Other Problems | | |
| Patch does not change | Is something other than the Play screen shown in the display? | On the GT-100, patches can be selected only when the Play screen is displayed. Press [EXIT] to return to the Play screen (p. 21). |
| Parameters specified with Assign can't be controlled | Could the effect be switched off? | To control a parameter using the expression pedal or footswitch, make sure the effect that contains the parameter you intend to control is switched on. |
| | Could the pedal function "PREFERENCE" (p. 41) be set to "SYSTEM"? | If the preference is set to "SYSTEM," the patch assignment will be ignored. If you want to enable the settings of the patch, change the preference for the corresponding parameter to "PATCH". |
| | Do the MIDI channel settings of both devices match? | Make sure that the MIDI channels of both devices match (p. 44). |
| | Do the controller number settings of both devices match? | Make sure that the controller number of both devices match (p. 44). |
| | Could the expression pedal be out of adjustment? | Although the unit's expression pedal has been set for optimal operation at the factory, extended use and certain operating environments can result in the pedal going out of adjustment. Adjust the expression pedal (p. 36). |
| Can't save the phrase created using Phrase Loop. | The GT-100 cannot save phrases created using Phrase Loop. | |

Appendices

| Problem | Items to check | Action |
|--|---|--|
| MIDI messages are not transmitted/ received | Are the MIDI cables broken? | Try another set of MIDI cables. |
| | Is the GT-100 correctly connected to the other MIDI device? | Check connections with the other MIDI device. |
| | Do the MIDI channel settings of both devices match? | Make sure that the MIDI channels of both devices match (p. 44). |
| | When you send messages from the GT-100, make sure the GT-100 is set to the settings appropriate for sending data. | Check the on/off status for transmission of program change messages (p. 44) and the settings for the controller numbers to be transmitted (p. 44). |

Error Messages

| Display | Problem | Action |
|----------------------------|---|---|
| MIDI BUFFER FULL! | The data cannot be processed correctly due to the high volume of MIDI messages. | Reduce the volume of MIDI messages transmitted to the GT-100. Reduce the tempo of the transmitting MIDI device. |
| MIDI OFFLINE! | Transmissions from the connected device have been interrupted. This message also appears when the power to the connected device has been turned off. It does not indicate damage. | Check to make sure no cable is disconnected and that there are no shorts. |
| USB OFFLINE! | | |
| DATA WRITE ERROR! | Writing to the memory for storage of user data failed. | The unit may be damaged. Consult the nearest Roland service center. |
| OUT OF RANGE! SET AGAIN | The [EXP] pedal cannot be calibrated. | Confirm the calibration by carrying out the procedure once more (p. 36). If the message continues to appear even after the calibration is correctly performed, it may indicate damage or malfunction. Consult your Roland dealer or contact Roland Service Center. |
| KNOB IS LOCKED! | The knobs are locked. | Turn "KNOB LOCK" off (p. 41). |
| PREFERENCE IS SYSTEM! | The "PREFERENCE" (p. 41) is set to "SYSTEM." | If the preference is set to "SYSTEM," the patch assignment and manual mode settings will be ignored. If you want to enable the settings of the patch, change the preference for the corresponding parameter to "PATCH". |
| PEDAL FUNC IS PHRASE LOOP! | The "PEDAL FUNC" (p. 32) is set to "PHRASE LOOP" | If the phrase loop pedal function is set to "PHRASE LOOP," the patch assignment and manual mode settings will be ignored. If you want to enable the settings of the patch, set the "PHRASE LOOP PEDAL FUNC" to "OFF". |

Main Specifications

BOSS GT-100: Amp Effects Processor

| | | |
|---------------------------|---|---|
| AD Conversion | 24 bits + AF method * AF method (Adaptive Focus method) This is a proprietary method from Roland & BOSS that vastly improves the signal-to-noise (S/N) ratio of the A/D and D/A converters. | |
| DA Conversion | 24 bits | |
| Sampling Rate | 44.1 kHz | |
| Program Memories | 400: 200 (User) + 200 (Preset) | |
| Nominal Input Level | INPUT: -10 dBu | |
| | RETURN: -10 dBu | |
| | AUX IN: -20 dBu | |
| Input Impedance | INPUT: 1 M ohm | |
| | RETURN: 100 k ohms | |
| | AUX IN: 47 k ohms | |
| Nominal Output Level | OUTPUT: -10 dBu/+4 dBu | |
| | SEND: -10 dBu | |
| Output Impedance | OUTPUT: 2 k ohms | |
| | SEND: 2 k ohms | |
| Dynamic Range | 100 dB or greater (IHF-A) | |
| Displays | Graphic LCD (132 x 64 dots, backlit LCD) x 2 | |
| Connectors | INPUT jack (1/4-inch phone type) | |
| | AUX IN jack (Stereo miniature phone type) | |
| | OUTPUT jacks L/MONO, R (1/4-inch phone type) | |
| | PHONES jack (Stereo 1/4-inch phone type) | |
| | EXT LOOP jacks SEND, RETURN (1/4-inch phone type) | |
| | AMP CONTROL jack (1/4-inch phone type) | |
| | SUB CTL 1, 2/SUB EXP jack (1/4-inch TRS phone type) | |
| | USB port | |
| | MIDI connectors IN, OUT | |
| Power Supply | DC 9 V | |
| | Current Draw | |
| Dimensions | 542 (W) x 271 (D) x 80 (H) mm 21-3/8 (W) x 10-11/16 (D) x 3-3/16 (H) inches | |
| | Maximum height: 542 (W) x 271 (D) x 102 (H) mm 21-3/8 (W) x 10-11/16 (D) x 4-1/16 (H) inches | |
| Weight | 4.8 kg / 10 lbs 10 oz (excluding AC Adaptor) | |
| Accessories | AC Adaptor , USB Cap, Owner's Manual | |
| Options (sold separately) | Footswitch | BOSS FS-5U |
| | Dual Footswitch | BOSS FS-6 |
| | Expression Pedal | BOSS FV-500L, BOSS FV-500H, Roland EV-5 |

* 0 dBu = 0.775 Vrms

* In the interest of product improvement, the specifications and/or appearance of this unit are subject to change without prior notice.

Index

| | | | | | |
|--------------------------------|------------|--|--|--------------------------------|--------|
| A | | | | S | |
| A/B SOLO..... | 35 | | | Saving a Patch..... | 13 |
| A&B SOLO..... | 35 | | | Security Slot..... | 23 |
| ACC/CTL OUT..... | 45 | | | SEND LEVEL..... | 29 |
| [ACCEL/CTL] pedal..... | 19 | | | Send/Return..... | 29 |
| Accel Effect..... | 19 | | | Signal Flow..... | 60 |
| ACT RANGE HI..... | 37 | | | Single mode..... | 27 |
| ACT RANGE LO..... | 37 | | | SOLO SW..... | 21 |
| Amp Control..... | 28 | | | SOURCE..... | 37 |
| AMP CTL jack..... | 22 | | | SOURCE MODE..... | 37 |
| Assign..... | 37 | | | SPREAD..... | 28 |
| ASSIGN ON/OFF..... | 37 | | | SUB CTL 1, 2/SUB EXP jack..... | 22 |
| AUTO OFF..... | 42 | | | SUB CTL1 OUT..... | 45 |
| AUX IN jack..... | 22 | | | SUB CTL2 OUT..... | 45 |
| | | | | SUB EXP OUT..... | 46 |
| B | | | | SUB EXP PEDAL..... | 34 |
| Bank..... | 10 | | | Switching the Unit On..... | 24 |
| BPM..... | 21 | | | SYNC CLOCK..... | 44 |
| Bulk Dump..... | 48 | | | System..... | 12 |
| | | | | [SYSTEM] button..... | 40 |
| C | | | | System Settings..... | 40 |
| Ch. A/B..... | 35 | | | | |
| CH A/B BALANC..... | 28 | | | T | |
| CH. A CUTOFF FREQ..... | 27 | | | TARGET..... | 37 |
| CH. A DYNAMIC..... | 27 | | | TARGET CATEGORY..... | 37 |
| CH. A DYNAMIC SENS..... | 27 | | | TARGET MAX..... | 37 |
| CH. A FILTER..... | 27 | | | TARGET MIN..... | 37 |
| CH. B CUTOFF FREQ..... | 27 | | | TEMPO..... | 25 |
| CH. B DYNAMIC..... | 27 | | | TO..... | 46 |
| CH. B DYNAMIC SENS..... | 27 | | | TOTAL..... | 40 |
| CH. B FILTER..... | 27 | | | Troubleshooting..... | 61 |
| CH SELECT..... | 27 | | | tuner..... | 8 |
| Computer..... | 49 | | | TUNER..... | 35 |
| Control Change Messages..... | 47 | | | TX CHANNEL..... | 44 |
| Control/Expression..... | 12 | | | | |
| [CTL/EXP] button..... | 33, 37 | | | U | |
| | | | | USB..... | 43 |
| D | | | | USB audio flow..... | 43 |
| DC IN jack..... | 23 | | | USB Driver..... | 49 |
| DEVICE ID..... | 44 | | | USB IN-OUT MODE..... | 43 |
| DIR. MONITOR..... | 44 | | | USB port..... | 23 |
| DIR. MONITOR CMD..... | 44 | | | User Banks..... | 25 |
| Display..... | 20 | | | | |
| Divider..... | 27 | | | W | |
| Dual mode..... | 27 | | | WAVEFORM..... | 38 |
| | | | | Wave Pedal..... | 39 |
| E | | | | WAVE RATE..... | 38 |
| [EFFECT] button..... | 16, 19 | | | [WRITE] button..... | 13, 30 |
| Effects..... | 16, 27 | | | | |
| Error Messages..... | 62 | | | | |
| EXP OUT..... | 45 | | | | |
| [EXP] pedal..... | 20, 36 | | | | |
| EXP PEDAL..... | 34 | | | | |
| EXP PEDAL SW..... | 11 | | | | |
| EXP SW OUT..... | 45 | | | | |
| EXT LOOP SEND/RETURN jack..... | 22 | | | | |
| EZ (Easy) Tone..... | 12, 14 | | | | |
| [EZ TONE] button..... | 14 | | | | |
| | | | | | |
| F | | | | | |
| FACTORY RESET..... | 42, 50 | | | | |
| FROM..... | 46 | | | | |
| FUNC..... | 34 | | | | |
| FX1/FX2 Effects List..... | 53 | | | | |
| | | | | | |
| G | | | | | |
| GLOBAL EQ..... | 40 | | | | |
| Grounding Terminal..... | 23 | | | | |
| GT-100 Effects List..... | 51 | | | | |
| | | | | | |
| I | | | | | |
| INPUT..... | 40 | | | | |
| INPUT jack..... | 22 | | | | |
| Input Level..... | 39 | | | | |
| INPUT SENS..... | 37 | | | | |
| Internal Pedal..... | 39 | | | | |
| INT PDL CURVE..... | 38 | | | | |
| INT PDL TIME..... | 38 | | | | |
| INT PDL TRIGGER..... | 38 | | | | |
| | | | | | |
| K | | | | | |
| Knob Functions..... | 35 | | | | |
| KNOB SETTING..... | 41 | | | | |
| | | | | | |
| L | | | | | |
| LCD..... | 41 | | | | |
| LIFT/GND switch..... | 22 | | | | |
| Loop Play..... | 32 | | | | |
| | | | | | |
| M | | | | | |
| Manual Mode..... | 17 | | | | |
| MAP SELECT..... | 45 | | | | |
| Master BPM..... | 21, 25 | | | | |
| Metronome..... | 25 | | | | |
| MIDI BULK DUMP..... | 46 | | | | |
| MIDI IN SELECT..... | 45 | | | | |
| MIDI jack..... | 23 | | | | |
| MIDI PROGRAM MAP BANK 0-3..... | 46 | | | | |
| MIDI SETTING..... | 44 | | | | |
| Mixer..... | 27 | | | | |
| MODE..... | 27, 28, 32 | | | | |
| | | | | | |
| O | | | | | |
| OD/DS Type List..... | 52 | | | | |
| OD SOLO..... | 35 | | | | |
| OMNI MODE..... | 44 | | | | |
| OUTPUT jacks..... | 22 | | | | |
| OUTPUT LEVEL..... | 44 | | | | |
| OUTPUT SELECT..... | 9, 40 | | | | |
| | | | | | |
| P | | | | | |
| Patch..... | 10 | | | | |
| PATCH EXCHANGE..... | 30 | | | | |
| PATCH INITIALIZE..... | 30 | | | | |
| PATCH LEVEL MAX..... | 34 | | | | |
| PATCH LEVEL MIN..... | 34 | | | | |
| PATCH WRITE..... | 30 | | | | |
| PC#1-PC#128..... | 46 | | | | |
| PC OUT..... | 45 | | | | |
| PEDAL CALIBRATION..... | 41 | | | | |
| PEDAL FUNC..... | 32 | | | | |
| pedals..... | 11 | | | | |
| Pedal Settings..... | 33 | | | | |
| PH.LOOP OUT..... | 45 | | | | |
| PHONES jack..... | 22 | | | | |
| Phrase Loop..... | 18 | | | | |
| [PHRASE LOOP] pedal..... | 18, 32 | | | | |
| PLAY LEVEL..... | 32 | | | | |
| PLAY OPTION..... | 41 | | | | |
| Play screen..... | 11, 21 | | | | |
| [POWER] switch..... | 23 | | | | |
| Preamp Type List..... | 52 | | | | |
| PREFERENCE..... | 41 | | | | |
| Preset Banks..... | 25 | | | | |
| Program Change Map..... | 47 | | | | |
| Program Change Messages..... | 47 | | | | |
| | | | | | |
| Q | | | | | |
| Quick Setting Write..... | 31 | | | | |
| | | | | | |
| R | | | | | |
| REC MODE..... | 32 | | | | |
| RETURN LEVEL..... | 29 | | | | |
| RX CHANNEL..... | 44 | | | | |

For the U.K.

IMPORTANT: THE WIRES IN THIS MAINS LEAD ARE COLOURED IN ACCORDANCE WITH THE FOLLOWING CODE.

BLUE: NEUTRAL
BROWN: LIVE

As the colours of the wires in the mains lead of this apparatus may not correspond with the coloured markings identifying the terminals in your plug, proceed as follows:

The wire which is coloured BLUE must be connected to the terminal which is marked with the letter N or coloured BLACK.
The wire which is coloured BROWN must be connected to the terminal which is marked with the letter L or coloured RED.
Under no circumstances must either of the above wires be connected to the earth terminal of a three pin plug.

For EU Countries



This product complies with the requirements of EMC Directive 2004/108/EC.

For the USA

FEDERAL COMMUNICATIONS COMMISSION RADIO FREQUENCY INTERFERENCE STATEMENT

This equipment has been tested and found to comply with the limits for a Class B digital device, pursuant to Part 15 of the FCC Rules. These limits are designed to provide reasonable protection against harmful interference in a residential installation. This equipment generates, uses, and can radiate radio frequency energy and, if not installed and used in accordance with the instructions, may cause harmful interference to radio communications. However, there is no guarantee that interference will not occur in a particular installation. If this equipment does cause harmful interference to radio or television reception, which can be determined by turning the equipment off and on, the user is encouraged to try to correct the interference by one or more of the following measures:

- Reorient or relocate the receiving antenna.
- Increase the separation between the equipment and receiver.
- Connect the equipment into an outlet on a circuit different from that to which the receiver is connected.
- Consult the dealer or an experienced radio/TV technician for help.

This device complies with Part 15 of the FCC Rules. Operation is subject to the following two conditions:

- (1) this device may not cause harmful interference, and
- (2) this device must accept any interference received, including interference that may cause undesired operation.

This equipment requires shielded interface cables in order to meet FCC class B limit.

Any unauthorized changes or modifications not expressly approved by the party responsible for compliance could void the user's authority to operate the equipment.

For Canada

NOTICE

This Class B digital apparatus meets all requirements of the Canadian Interference-Causing Equipment Regulations.

AVIS

Cet appareil numérique de la classe B respecte toutes les exigences du Règlement sur le matériel brouilleur du Canada.

For C.A. US (Proposition 65)

WARNING

This product contains chemicals known to cause cancer, birth defects and other reproductive harm, including lead.

For the USA

DECLARATION OF CONFORMITY Compliance Information Statement

Model Name : GT-100
Type of Equipment : Guitar Effects
Responsible Party : Roland Corporation U.S.
Address : 5100 S. Eastern Avenue, Los Angeles, CA 90040-2938
Telephone : (323) 890-3700

For EU Countries



- UK** This symbol indicates that in EU countries, this product must be collected separately from household waste, as defined in each region. Products bearing this symbol must not be discarded together with household waste.
- DE** Dieses Symbol bedeutet, dass dieses Produkt in EU-Ländern getrennt vom Hausmüll gesammelt werden muss gemäß den regionalen Bestimmungen. Mit diesem Symbol gekennzeichnete Produkte dürfen nicht zusammen mit den Hausmüll entsorgt werden.
- FR** Ce symbole indique que dans les pays de l'Union européenne, ce produit doit être collecté séparément des ordures ménagères selon les directives en vigueur dans chacun de ces pays. Les produits portant ce symbole ne doivent pas être mis au rebut avec les ordures ménagères.
- IT** Questo simbolo indica che nei paesi della Comunità europea questo prodotto deve essere smaltito separatamente dai normali rifiuti domestici, secondo la legislazione in vigore in ciascun paese. I prodotti che riportano questo simbolo non devono essere smaltiti insieme ai rifiuti domestici. Ai sensi dell'art. 13 del D.Lgs. 25 luglio 2005 n. 151.
- ES** Este símbolo indica que en los países de la Unión Europea este producto debe recogerse aparte de los residuos domésticos, tal como está regulado en cada zona. Los productos con este símbolo no se deben depositar con los residuos domésticos.
- PT** Este símbolo indica que nos países da UE, a recolha deste produto deverá ser feita separadamente do lixo doméstico, de acordo com os regulamentos de cada região. Os produtos que apresentem este símbolo não deverão ser eliminados juntamente com o lixo doméstico.
- NL** Dit symbool geeft aan dat in landen van de EU dit product gescheiden van huishoudelijk afval moet worden aangeboden, zoals bepaald per gemeente of regio. Producten die van dit symbool zijn voorzien, mogen niet samen met huishoudelijk afval worden verwijderd.
- DK** Dette symbol angiver, at i EU-lande skal dette produkt opsamles adskilt fra husholdningsaffald, som defineret i hver enkelt region. Produkter med dette symbol må ikke smides ud sammen med husholdningsaffald.
- NO** Dette symbolet indikerer at produktet må behandles som spesialavfall i EU-land, iht. til retningslinjer for den enkelte regionen, og ikke kastes sammen med vanlig husholdningsavfall. Produkter som er merket med dette symbolet, må ikke kastes sammen med vanlig husholdningsavfall.

- SE** Symbolen anger att i EU-länder måste den här produkten kasseras separat från hushållsavfall, i enlighet med varje regions bestämmelser. Produkter med den här symbolen får inte kasseras tillsammans med hushållsavfall.
- FI** Tämä merkintä ilmaisee, että tuote on EU-maissa kerättävä erillään kotitalousjätteistä kunkin alueen voimassa olevien määräysten mukaisesti. Tällä merkinnällä varustettuja tuotteita ei saa hävittää kotitalousjätteiden mukana.
- HU** Ez a szimbólum azt jelenti, hogy az Európai Unióban ezt a terméket a háztartási hulladéktól elkülönítve, az adott régióban érvényes szabályozás szerint kell gyűjteni. Az ezzel a szimbólummal ellátott termékeket nem szabad a háztartási hulladék közé dobni.
- PL** Symbol oznacza, że zgodnie z regulacjami w odpowiednim regionie, w krajach UE produktu nie należy wyrzucać z odpadami domowymi. Produktów opatrzonych tym symbolem nie można utylizować razem z odpadami domowymi.
- CZ** Tento symbol udává, že v zemích EU musí být tento výrobek sbírán odděleně od domácího odpadu, jak je určeno pro každý region. Výrobky nesoucí tento symbol se nesmí vyhazovat spolu s domácím odpadem.
- SK** Tento symbol vyjadruje, že v krajinách EÚ sa musí zber tohto produktu vykonávať oddelene od domového odpadu, podľa nariadení platných v konkrétnej krajine. Produkty s týmto symbolom sa nesmú vyhazovať spolu s domovým odpadom.
- EE** See sümbol näitab, et EL-i maades tuleb see toode olemprügist eraldi koguda, nii nagu on igas piirkonnas määratletud. Selle sümboliga märgitud tooteid ei tohi ära visata koos olmeprügiga.
- LT** Šis simbolis rodo, kad ES šalyse šis produktas turi būti surenkamas atskirai nuo buitinių atliekų, kaip nustatyta kiekviename regione. Šiuo simboliu paženklinėti produktai neturi būti išmetami kartu su buitiniemis atliekomis.
- LV** Šis simbols norāda, ka ES valstīs šo produktu jāievāc atsevišķi no mājsaimniecības atkritumiem, kā noteikts katrā reģionā. Produkts ar šo simbolu nedrīkst izmest kopā ar mājsaimniecības atkritumiem.
- SI** Ta simbol označuje, da je treba proizvod v državah EU zbirati ločeno od gospodinskih odpadkov, tako kot je določeno v vsaki regiji. Proizvoda s tem znakom ni dovoljeno odlagati skupaj z gospodinskimi odpadki.
- GR** Το σύμβολο αυτό υποδηλώνει ότι στις χώρες της Ε.Ε. το συγκεκριμένο προϊόν πρέπει να συλλέγεται χωριστά από τα υπόλοιπα οικιακά απορρίμματα, σύμφωνα με όσα προβλέπονται σε κάθε περιοχή. Τα προϊόντα που φέρουν το συγκεκριμένο σύμβολο δεν πρέπει να απορρίπτονται μαζί με τα οικιακά απορρίμματα.

For China

有关产品中所含有害物质的说明

本资料就本公司产品中所含的特定有害物质及其安全性予以说明。
本资料适用于 2007 年 3 月 1 日以后本公司所制造的产品。

环保使用期限



此标志适用于在中国国内销售的电子信息产品，表示环保使用期限的年数。所谓环保使用期限是指在自制造日期的规定期限内，产品中所含的有害物质不致引起环境污染，不会对人身、财产造成严重的不良影响。
环保使用期限仅在遵照产品使用说明书，正确使用产品的条件下才有效。
不当的使用，将会导致有害物质泄漏的危险。

产品中有毒有害物质或元素的名称及含量

| 部件名称 | 有毒有害物质或元素 | | | | | |
|----------------|-----------|-------|-------|-------------|-----------|-------------|
| | 铅(Pb) | 汞(Hg) | 镉(Cd) | 六价铬(Cr(VI)) | 多溴联苯(PBB) | 多溴二苯醚(PBDE) |
| 外壳(壳体) | × | ○ | ○ | ○ | ○ | ○ |
| 电子部件(印刷电路板等) | × | ○ | × | ○ | ○ | ○ |
| 附件(电源线、交流适配器等) | × | ○ | ○ | ○ | ○ | ○ |

○：表示该有毒有害物质在该部件所有均质材料中的含量均在 SJ/T11363-2006 标准规定的限量要求以下。
×：表示该有毒有害物质至少在该部件的某一均质材料中的含量超出 SJ/T11363-2006 标准规定的限量要求。
因根据现有的技术水平，还没有什么物质能够代替它。

 **BOSS**

