

## RSS Ambience System (RSS Multi-Channel Digital Reverb)

# RSS-303

## Owner's Manual

Before using this unit, carefully read the sections entitled: "USING THE UNIT SAFELY" (p. 2) and "IMPORTANT NOTES" (p. 6). These sections provide important information concerning the proper operation of the unit. Additionally, in order to feel assured that you have gained a good grasp of every feature provided by your new unit, this manual should be read in its entirety. The manual should be saved and kept on hand as a convenient reference.

### Conventions in this manual

- Characters and numerals enclosed in square brackets [ ] indicate buttons or knobs on the panel.
- Example: [EXIT] indicates the EXIT button (press the VALUE knob).
- ☞ indicates information for your reference, "■ ..." is a section to which you can refer, and (->P.\*\*\*) indicates a reference page.
- "○ ..." indicates a choice that you can make, and multiple instances of ○ on the same level mean that you should choose one of them.
- "□1" indicates a step of a procedure. To ensure best results, check each step and perform them in the numerical order given.
- ● indicates each section of the explanation.

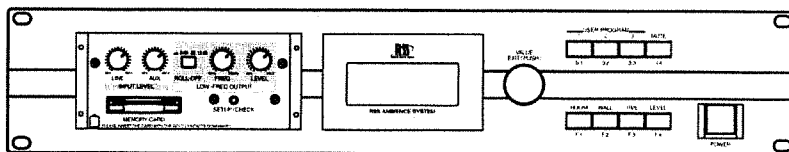

For the procedures that you will use normally, refer to the locations given here.

#### Using the RSS-303 with a Rodgers Organ

- Turning on Power ☞ page 9
- Turning off Power ☞ page 9
- Selecting a User Program ☞ page 10
- Muting Ambience Sound ☞ page 11

#### Using the RSS-303 by Itself



- Turning on Power ☞ page 12
- Turning off Power ☞ page 12
- Selecting a User Program ☞ page 14
- Muting Ambience Sound ☞ page 15

For the procedures used at the time of installation, refer to the pages given below.

- Placement, Setting, and Adjustment Procedure ☞ page 55
- Preparations for Settings ☞ page 55
- Starting Setup ☞ page 57
- Adjusting Reverberation Tone ☞ page 58

Copyright © 2000 ROLAND CORPORATION

All Reserved. No part of this publication may be reproduced in any form without the written permission of ROLAND CORPORATION.

	<b>CAUTION</b> RISK OF ELECTRIC SHOCK DO NOT OPEN	
<b>ATTENTION</b> RISQUE DE CHOC ELECTRIQUE NE PAS OUVRIR		
<b>CAUTION: TO REDUCE THE RISK OF ELECTRIC SHOCK, DO NOT REMOVE COVER (OR BACK). NO USER-SERVICEABLE PARTS INSIDE. REFER SERVICING TO QUALIFIED SERVICE PERSONNEL.</b>		



The lightning flash with arrowhead symbol, within an equilateral triangle, is intended to alert the user to the presence of uninsulated "dangerous voltage" within the product's enclosure that may be of sufficient magnitude to constitute a risk of electric shock to persons.



The exclamation point within an equilateral triangle is intended to alert the user to the presence of important operating and maintenance (servicing) instructions in the literature accompanying the product.

INSTRUCTIONS PERTAINING TO A RISK OF FIRE, ELECTRIC SHOCK, OR INJURY TO PERSONS.

## IMPORTANT SAFETY INSTRUCTIONS SAVE THESE INSTRUCTIONS

**WARNING** - When using electric products, basic precautions should always be followed, including the following:

1. Read these instructions.
2. Keep these instructions.
3. Heed all warnings.
4. Follow all instructions.
5. Do not use this apparatus near water.
6. Clean only with a damp cloth.
7. Do not block any of the ventilation openings. Install in accordance with the manufacturers instructions.
8. Do not install near any heat sources such as radiators, heat registers, stoves, or other apparatus (including amplifiers) that produce heat.
9. Do not defeat the safety purpose of the polarized or grounding-type plug. A polarized plug has two blades with one wider than the other. A grounding type plug has two blades and a third grounding prong. The wide blade or the third prong are provided for your safety. When the provided plug does not fit into your outlet, consult an electrician for replacement of the obsolete outlet.
10. Protect the power cord from being walked on or pinched particularly at plugs, convenience receptacles, and the point where they exit from the apparatus.
11. Only use attachments/accessories specified by the manufacturer.
12. Unplug this apparatus during lightning storms or when unused for long periods of time.
13. Refer all servicing to qualified service personnel. Servicing is required when the apparatus has been damaged in any way, such as power-supply cord or plug is damaged, liquid has been spilled or objects have fallen into the apparatus, the apparatus has been exposed to rain or moisture, does not operate normally, or has been dropped.

**For the U.K.**



**WARNING:** THIS APPARATUS MUST BE EARTHED  
**IMPORTANT:** THE WIRES IN THIS MAINS LEAD ARE COLOURED IN ACCORDANCE WITH THE FOLLOWING CODE.  
 GREEN-AND-YELLOW: EARTH, BLUE: NEUTRAL, BROWN: LIVE

As the colours of the wires in the mains lead of this apparatus may not correspond with the coloured markings identifying the terminals in your plug, proceed as follows:  
 The wire which is coloured GREEN-AND-YELLOW must be connected to the terminal in the plug which is marked by the letter E or by the safety earth symbol  or coloured GREEN or GREEN-AND-YELLOW.  
 The wire which is coloured BLUE must be connected to the terminal which is marked with the letter N or coloured BLACK.  
 The wire which is coloured BROWN must be connected to the terminal which is marked with the letter L or coloured RED.







## USING THE UNIT SAFELY

INSTRUCTIONS FOR THE PREVENTION OF FIRE, ELECTRIC SHOCK, OR INJURY TO PERSONS

About  **WARNING** and  **CAUTION** Notices













 <b>WARNING</b>	Used for instructions intended to alert the user to the risk of death or severe injury should the unit be used improperly.
 <b>CAUTION</b>	Used for instructions intended to alert the user to the risk of injury or material damage should the unit be used improperly. * Material damage refers to damage or other adverse effects caused with respect to the home and all its furnishings, as well to domestic animals or pets.

About the Symbols





	The  symbol alerts the user to important instructions or warnings. The specific meaning of the symbol is determined by the design contained within the triangle. In the case of the symbol at left, it is used for general cautions, warnings, or alerts to danger.
	The  symbol alerts the user to items that must never be carried out (are forbidden). The specific thing that must not be done is indicated by the design contained within the circle. In the case of the symbol at left, it means that the unit must never be disassembled.
	The  symbol alerts the user to things that must be carried out. The specific thing that must be done is indicated by the design contained within the circle. In the case of the symbol at left, it means that the power-cord plug must be unplugged from the outlet.

----- **ALWAYS OBSERVE THE FOLLOWING** -----









**⚠ WARNING**

- Before using this unit, make sure to read the instructions below, and the Owner's Manual. 
- Do not open or perform any internal modifications on the unit. 
- Do not attempt to repair the unit, or replace parts within it (except when this manual provides specific instructions directing you to do so). Refer all servicing to your retailer, the nearest Roland Service Center, or an authorized Roland distributor, as listed on the "Information" page. 
- Never use or store the unit in places that are:
  - Subject to temperature extremes (e.g., direct sunlight in an enclosed vehicle, near a heating duct, on top of heat-generating equipment); or are 
  - Damp (e.g., baths, washrooms, on wet floors); or are 
  - Humid; or are
  - Exposed to rain; or are
  - Dusty; or are
  - Subject to high levels of vibration.
- This unit should be used only with a rack or stand that is recommended by Roland. 
- When using the unit with a rack or stand recommended by Roland, the rack or stand must be carefully placed so it is level and sure to remain stable. If not using a rack or stand, you still need to make sure that any location you choose for placing the unit provides a level surface that will properly support the unit, and keep it from wobbling. 
- The unit should be connected to a power supply only of the type described in the operating instructions, or as marked on the unit. 
- Do not excessively twist or bend the power cord, nor place heavy objects on it. Doing so can damage the cord, producing severed elements and short circuits. Damaged cords are fire and shock hazards! 
- This unit, either alone or in combination with an amplifier and headphones or speakers, may be capable of producing sound levels that could cause permanent hearing loss. Do not operate for a long period of time at a high volume level, or at a level that is uncomfortable. If you experience any hearing loss or ringing in the ears, you should immediately stop using the unit, and consult an audiologist. 
- Do not allow any objects (e.g., flammable material, coins, pins); or liquids of any kind (water, soft drinks, etc.) to penetrate the unit.   

**⚠ WARNING**

- In households with small children, an adult should provide supervision until the child is capable of following all the rules essential for the safe operation of the unit. 
- Protect the unit from strong impact. (Do not drop it!) 
- Do not force the unit's power-supply cord to share an outlet with an unreasonable number of other devices. Be especially careful when using extension cords—the total power used by all devices you have connected to the extension cord's outlet must never exceed the power rating (watts/amperes) for the extension cord. Excessive loads can cause the insulation on the cord to heat up and eventually melt through. 
- Before using the unit in a foreign country, consult with your retailer, the nearest Roland Service Center, or an authorized Roland distributor, as listed on the "Information" page. 

**⚠ CAUTION**

- The unit should be located so that its location or position does not interfere with its proper ventilation. 
- Always grasp only the plug on the power-supply cord when plugging into, or unplugging from, an outlet or this unit. 
- Try to prevent cords and cables from becoming entangled. Also, all cords and cables should be placed so they are out of the reach of children. 
- Never climb on top of, nor place heavy objects on the unit. 
- Never handle the power cord or its plugs with wet hands when plugging into, or unplugging from, an outlet or this unit. 
- Before moving the unit, disconnect the power plug from the outlet, and pull out all cords from external devices. 
- Before cleaning the unit, turn off the power and unplug the power cord from the outlet (p. 9, 12). 
- Whenever you suspect the possibility of lightning in your area, pull the plug on the power cord out of the outlet. 
- Should you remove the mounting screws for the protective cover, make sure to put them in a safe place out of children's reach, so there is no chance of them being swallowed accidentally. 

# Main Features

- **High-quality reverb ideal for musical performance**

Three-dimensional RSS (Roland Sound Space) acoustical technology is applied to produce high-quality three-dimensional reverberation.

- **Room modeling**

The reverberation of a variety of spaces such as cathedrals and concert halls is modeled as various room types.

- **16 room types built in**

The RSS-303 provides eight room types optimized for the Rodgers organ and an additional eight room types for broader application.

- **16 wall types**

The RSS-303 provides eight wall types optimized for the Rodgers organ and an additional eight wall types for broader application.

- **Easy operation**

COSM, a user-friendly parameter modeling technology, allows you to edit using a manageable number of easily understood parameters.

- **Sound source directionality is considered**

The direction of the early reflections is simulated based on the direction of the sound source.

- **Sound source location is taken into account**

The distance from the sound source is calculated to simulate the timing of the early reflections. This allows time alignment to occur automatically.

- **Reverberation optimized for installation location**

Simply by selecting the type (Field Type) for the location of your installation, you can easily optimize the settings for your location.

- **Three-band EQ compensates for the idiosyncrasies of the installed environment**

A three-band parametric equalizer is provided so you can compensate for speaker response or for the acoustical characteristics of the playback location.

- **Connection Check function for convenient installation**

This function helps you check that connections to multiple speakers have been made correctly.

- **Support for large systems containing multiple RSS-303 units**

One unit can be used as the master to control the entire system.

# Contents

<b>Front and Rear Panel .....</b>	<b>7</b>
<b>Basic Operation.....</b>	<b>8</b>
Before You Begin.....	8
<b>Using the RSS-303 with a Rodgers Organ.....</b>	<b>9</b>
Turning on Power.....	9
Turning off Power.....	9
Selecting a User Program.....	10
Muting Ambience Sound.....	11
<b>Using the RSS-303 by Itself.....</b>	<b>12</b>
Turning on Power.....	12
Turning off Power.....	12
Normal Operation Mode.....	13
Selecting a User Program.....	14
Muting Ambience Sound.....	15
Changing Room Type.....	16
Room Type List.....	17
Changing Wall Type.....	18
Wall Type List.....	19
Adjusting Reverb Ambience Time.....	20
Adjusting Ambience Level.....	21
Storing Your Settings as a User Program.....	22
<b>Settings and Adjustments.....</b>	<b>23</b>
About Field Settings.....	23
Starting Setup.....	24
Finishing Setup.....	25
Setup Help.....	26
Setup Menu.....	27
Checking Connections.....	28
Making Field Settings.....	31
Making Other Settings.....	34
User Mode Settings.....	36
Device ID Settings.....	37
LCD Screen Contrast.....	37
Factory Settings.....	38
Loading All Parameters.....	39
Saving All Parameters.....	40
Compensating for Speaker Response and Playback Location Acoustic Irregularities.....	41
Output High-pass Filter.....	42
Output Level Adjustment.....	42
<b>Input/Output, Setting Switches and Volumes .....</b>	<b>43</b>
The RSS-303's Inputs.....	43
Adjusting the RSS-303 Input Level.....	43
The RSS-303's Outputs.....	44
[SYSTEM OUTPUT] Settings.....	45
Low Frequency Output Adjustment.....	46
Controlling the Power.....	47
Remotely Controlling Power.....	47
Connection via the Special Cable to the Rodgers Organ.....	47
Controlling the Power Locally.....	48
Connecting the Remote Controller.....	48
<b>System Configuration.....</b>	<b>49</b>
Speaker Placement and Connections for a Basic System.....	49
Speaker Placement and Connections for a Simple System.....	51
Speaker Placement and Connections for an Extended System.....	53
<b>Placement, Setting, and Adjustment Procedure.....</b>	<b>55</b>
Preparations for Settings.....	55
Starting Setup.....	57
Adjusting Reverberation Tone.....	58
Contact Points for Rodgers Organs.....	59
<b>Specification.....</b>	<b>60</b>
<b>Index.....</b>	<b>62</b>

# Important Notes

In addition to the items listed under “IMPORTANT SAFETY INSTRUCTIONS” and “USING THE UNIT SAFELY” on pages 63 and 2, please read and observe the following:

## Power Supply

- Do not use this unit on the same power circuit with any device that will generate line noise (such as an electric motor or variable lighting system).
- Before connecting this unit to other devices, turn off the power to all units. This will help prevent malfunctions and/or damage to speakers or other devices.

## Placement

- Using the unit near power amplifiers (or other equipment containing large power transformers) may induce hum. To alleviate the problem, change the orientation of this unit; or move it farther away from the source of interference.
- This device may interfere with radio and television reception. Do not use this device in the vicinity of such receivers.
- Do not expose the unit to direct sunlight, place it near devices that radiate heat, leave it inside an enclosed vehicle, or otherwise subject it to temperature extremes. Excessive heat can deform or discolor the unit.
- To avoid possible breakdown, do not use the unit in a wet area, such as an area exposed to rain or other moisture.

## Maintenance

- For everyday cleaning wipe the unit with a soft, dry cloth or one that has been slightly dampened with water. To remove stubborn dirt, use a cloth impregnated with a mild, non-abrasive detergent. Afterwards, be sure to wipe the unit thoroughly with a soft, dry cloth.
- Never use benzine, thinners, alcohol or solvents of any kind, to avoid the possibility of discoloration and/or deformation.

## Additional Precautions

- Please be aware that the contents of memory can be irretrievably lost as a result of a malfunction, or the improper operation of the unit. To protect yourself against the risk of losing important data, we recommend that you periodically save a backup copy of important data you have stored in the unit's memory on a memory card.
- Unfortunately, it may be impossible to restore the contents of data that was stored on a memory card once it has been lost. Roland Corporation assumes no liability concerning such loss of data.
- Use a reasonable amount of care when using the unit's buttons, sliders, or other controls; and when using its jacks and connectors. Rough handling can lead to malfunctions.
- Never strike or apply strong pressure to the display.

- A small amount of noise may be heard from the display during normal operation.
- When connecting / disconnecting all cables, grasp the connector itself—never pull on the cable. This way you will avoid causing shorts, or damage to the cable's internal elements.
- A small amount of heat will radiate from the unit during normal operation.
- To avoid disturbing your neighbors, try to keep the unit's volume at reasonable levels (especially when it is late at night).
- When you need to transport the unit, package it in the box (including padding) that it came in, if possible. Otherwise, you will need to use equivalent packaging materials.
- Use a cable from Roland to make the connection. If using some other make of connection cable, please note the following precautions.
  - Some connection cables contain resistors. Do not use cables that incorporate resistors for connecting to this unit. The use of such cables can cause the sound level to be extremely low, or impossible to hear. For information on cable specifications, contact the manufacturer of the cable.
- The explanations in this manual include illustrations that depict what should typically be shown by the display. Note, however, that your unit may incorporate a newer, enhanced version of the system (e.g., includes newer sounds), so what you actually see in the display may not always match what appears in the manual.

# Front and Rear Panel

## ● Front panel

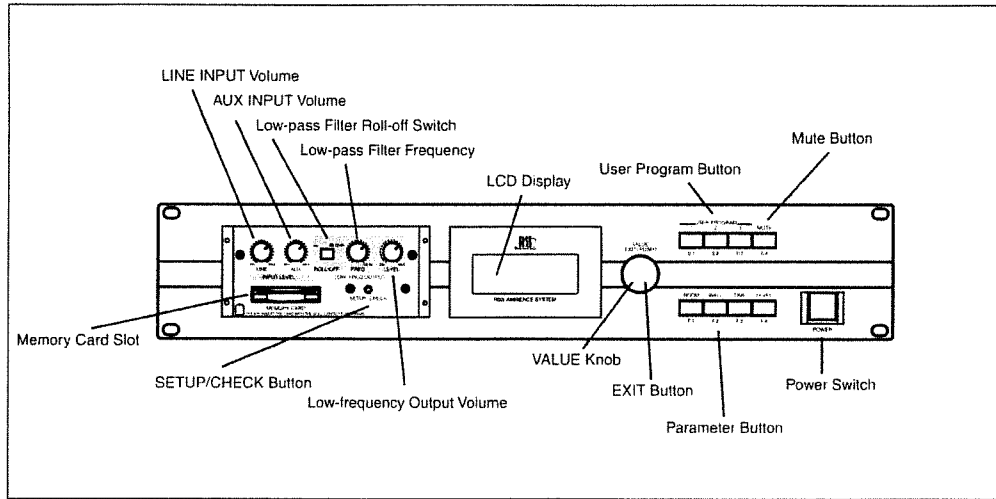

## ● Rear panel

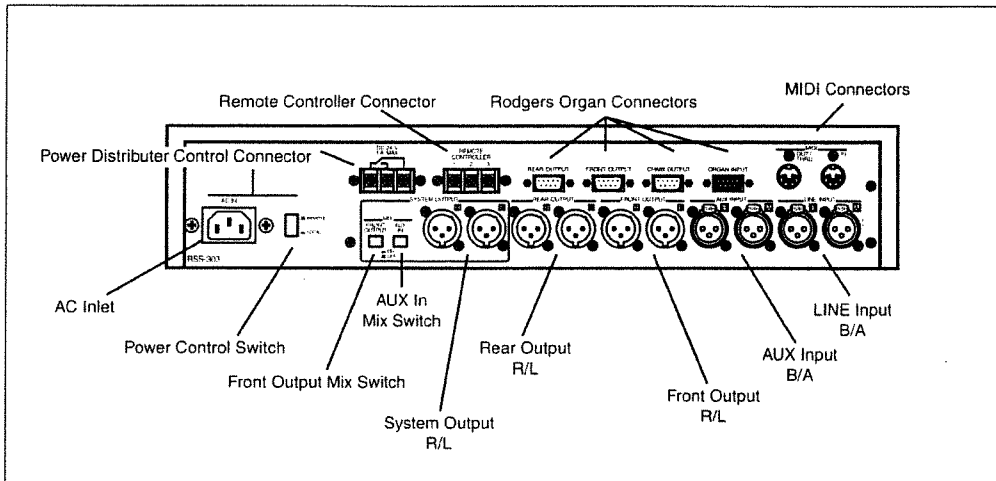

## ● Remote controller

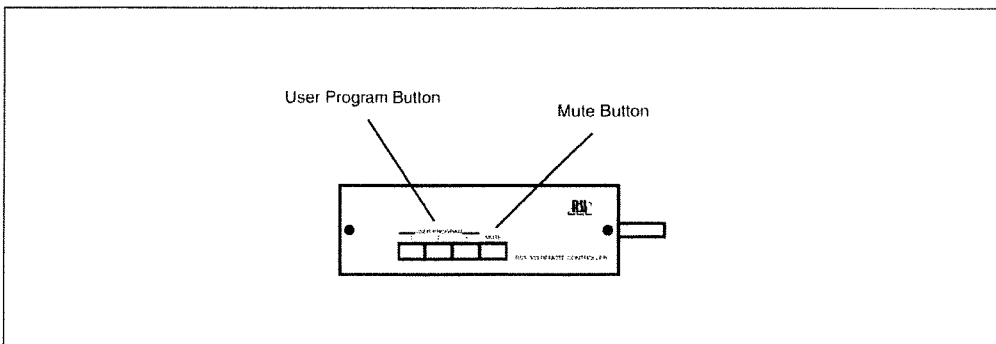

# Basic Operation

## ■ Before You Begin

### Connections

Make the connections as shown below, depending on how you will be using the RSS-303.

To prevent malfunction and/or damage to speakers or other devices, always turn down the volume, and turn off the power on all devices before making any connections.

The volume on your amplifier should be turned up only after switching on all the other units.

The pin assignments for the XLR type connectors are as shown below. Before making any connections, make sure that this pin assignment is compatible with that of all your other devices.

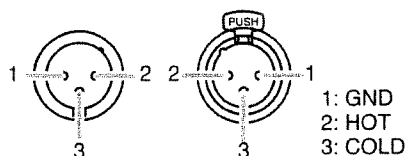

### Before Using Cards

#### Inserting Memory Cards

After making sure that the card faces up or down, and which end is to be inserted, firmly insert the card all the way into the slot.

Do not touch the memory card connector portion, or allow it to become contaminated.

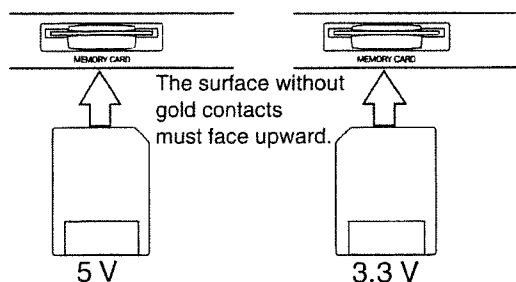

### Securing Memory Card Data

Write protect seals are included with memory cards. To protect important data from inadvertently being erased from a memory card, affix a write protect seal. The data on memory cards with write protect seals attached cannot be overwritten or erased (in situations such as formatting, saving programs, and copying).

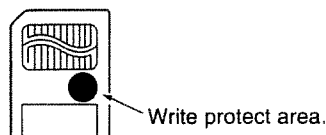



# Using the RSS-303 with a Rodgers Organ

This section explains basic operation of a system in which the RSS-303 is integrated with a Rodgers organ.

## ■ Turning on Power

### ● Turn on system power.

- 1 Turn on Rodgers organ power.

The display located in the center of the RSS-303 panel lights, indicating that power has been turned on.



The power switch located in the RSS-303's front panel should be left turned on.



If the power does not turn on, appropriate settings must be made so the power switch of the Rodgers organ controls the power of the entire system. For details contact the person responsible for your system installation.



For details on the settings  
Details are given in "■ Remotely Controlling Power."

☞ page 47

### ● Check.

- 2 Watch the display.

The display located in the center of the panel lights, and a screen like the following appears for several seconds.

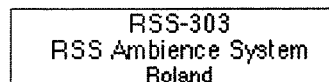

Then the RSS-303 enters normal operation mode.

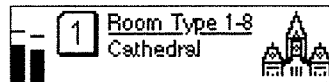

This display is only an example for illustrative purposes. The content of the display differs depending on the settings.

## ■ Turning off Power

### ● Turn off system power.

- 1 Turn off Rodgers organ power.

The display in the center of the RSS-303's front panel goes dark, indicating that the power has been turned off.



The power switch on the RSS-303's front panel should be left on.



If the power does not turn off, appropriate settings must be made so that the power switch of the Rodgers organ controls the power of the entire system. For details contact the person responsible for your system installation.



For details on the settings  
Details are given in "■ Remotely Controlling Power."

☞ page 47

---

## ■ Selecting a User Program

---

### ● In normal operation mode

In this mode, a screen like the following is displayed.

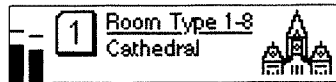

The screen shows the user program number and the room type selected.



This screen is just an example; the type name and the icons differ depending on the settings.

### ● Selecting a user program

In this state, you can recall one of three user programs.

The user programs already contain ambience sound settings.

To recall these settings, press the [USER PROGRAM] button [1], [2] or [3].

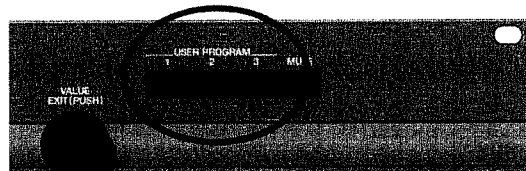

- 1 Press the button for the user program that you wish to recall.

■ appears, indicating that the program is now being recalled.

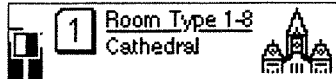

When the program has been recalled, the RSS-303 returns to normal operation mode.



In some cases, a display like the following may appear.

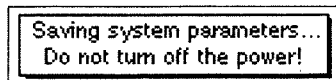

This means that internal processing is in progress. Never turn off the power while this screen is being displayed.

---

## ■ Muting Ambience Sound

---

Use this operation when you wish to mute only the reverberant sound added by the RSS ambience system.

### ● Temporarily mute ambience sound.

- 1 Press the [MUTE] button.



Only the ambience sound is muted. The direct sound is not muted.

### ● Cancel muting.

- 2 From the muted state, press the [MUTE] button again.



Muting is also cancelled when you select a user program.

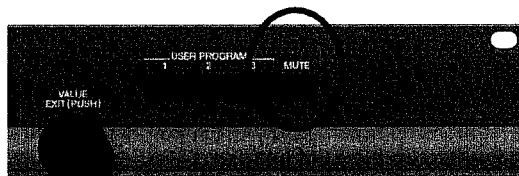

# Using the RSS-303 by Itself

## ■ Turning on Power

- \* Once the connections have been completed (p. 8), turn on power to various devices in the order specified. By turning on devices in the wrong order, you risk causing malfunction and/or damage to speakers and other devices.
- \* Always make sure to have the volume level turned down before switching on power. Even with the volume all the way down, you may still hear some sound when the power is switched on, but this is normal, and does not indicate a malfunction.

### ● Turn on the power.



- 1 Press the power switch located on the front panel.  
The display located in the center of the RSS-303 panel lights, indicating that the power has been turned on.

**?** If the power does not turn on, refer to  
"■Controlling the Power Locally." ☞ page 48

**NOTE** The method of turning on the power differs depending on your system.  
If you are using the RSS-303 with a Rodgers organ, refer to  
"■Remotely Controlling Power." ☞ page 47

### ● Check.

- 2 Watch the display.  
The display located in the center of the panel lights, and a screen like the following appears for several seconds.



The RSS-303 then enters normal operation mode.

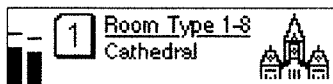

**NOTE** This display is only an example for illustrative purposes. The content of the display differs depending on the settings.

**NOTE** You may now begin normal operation. However, we recommend that you make settings in the following cases.

- When using the RSS-303 for the first time after installation.
- When the installed location has changed.
- When the speaker placement has changed, refer to  
"■About Field Settings." ☞ page 23  
"■Starting Setup." ☞ page 24

## ■ Turning off Power

- 1 Press the front panel power switch.  
The display in the center of the RSS-303's front panel darkens, indicating that the power is off.

**NOTE** If a separate switch has been provided for controlling the power of the entire system, the power switch on the RSS-303's front panel should be left on.

## ■ Normal Operation Mode

- In normal operation mode, the following screen is displayed.

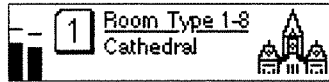

The user program number and the selected room type are displayed.



This display is just an example; the type name and the icons differ depending on the settings.

- You normally use the RSS-303 in this state.

In this state, the [VALUE] knob and [EXIT] button do nothing.

- From this state, you can perform the following operations.

- Press a user program button to recall settings.

Refer to "■Selecting a User Program."

☞ page 14

- Select and edit parameters.



These operations can be performed when the user mode is 1 or 0.

Refer to "■Changing Room Type."

☞ page 16

Refer to "■Changing Wall Type."

☞ page 18

Refer to "■Adjusting Reverb Ambience Time."

☞ page 20

Refer to "■Adjusting Ambience Level."

☞ page 21

- Press the MUTE button to temporarily mute the ambience sound.

Refer to "■Muting Ambience Sound."

☞ page 15

- Store the current settings as a user program.

Refer to "■Storing Your Settings as a User Program."

☞ page 22

- Remove the protective cover and enter Setup mode.

Refer to "■Starting Setup."

☞ page 24

---

## ■ Selecting a User Program

---

● **You may select one of three RSS-303 user programs.**

The user programs already contain ambience sound settings.

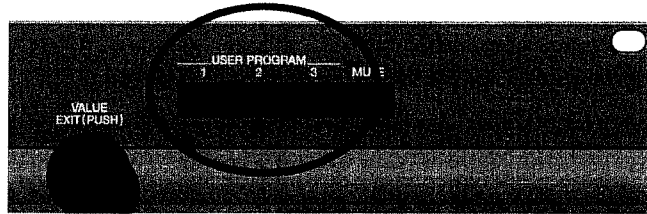

To recall these settings, press [USER PROGRAM] button [1], [2] or [3].

- 1 Press the button for the program that you wish to recall.

- If the currently selected settings have not been edited

- appears, indicating that the newly-selected settings are being recalled.

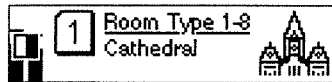

When recall is completed, the RSS-303 returns to normal operating mode.

- If the parameters have been edited:

A screen first asks whether you wish to discard your edits and recall the newly-selected settings.

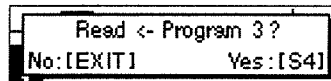

- If you decide not to recall:

- 2 Press the [EXIT] button

The recall operation is cancelled, and the RSS-303 returns to normal operating mode.

- If you decide to discard the current state and recall the new settings:

- 2 Press the [S4] button.

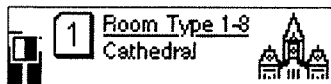

In some cases a display like the following may appear.

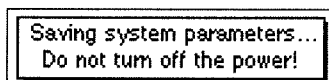

This means that internal processing is in progress. Never turn off the power while this screen is being displayed.

---

## ■ Muting Ambience Sound

---

Here's how you can mute only the reverberant sound that is added by the RSS ambience system.  
Do this when you would like to hear the difference that is being made by the RSS ambience system.

### ● Temporarily mute the ambience sound.

- 1 Press the [MUTE] button.

**NOTE** Only the ambience sound is muted. The direct sound is not muted.

### ● Cancel muting.

- 2 From the muted state, press the [MUTE] button again.

**NOTE** Muting is also cancelled if you select a user program.

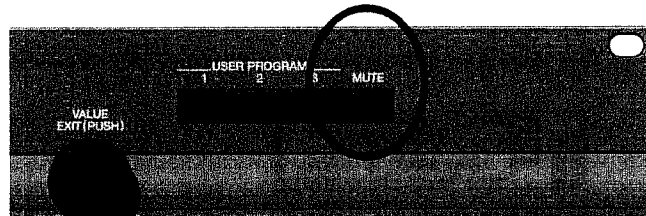

## ■ Changing Room Type

- Enter the mode in which you can change the room type.

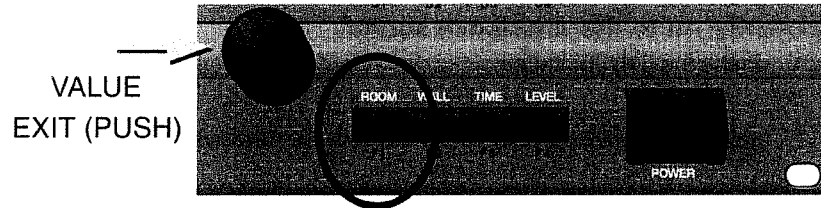

- 1 Press the [ROOM] button.

The following display appears:



If the User Mode is set to 2, the settings are protected. The display indicates:

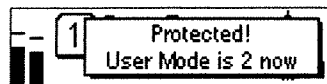

It is not possible to change the room type.



To change the user mode, refer to "■Making Other Settings"

☞ page 34

- Select Room Type

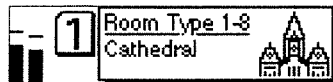

- 2 Rotate the [VALUE] knob to select the room type.

There are 16 available room type selections: 1.1 through 1.8 are compatible with the Trillium series of Rodgers organs, and 2.1 through 2.8 have been extended on the RSS-303. See "■Room Type List."

☞ page 17



When you change the room type, the ambience sound also changes.

- Exit.

- To exit this mode:

- 3 Press the [EXIT] button.

The RSS-303 returns to "■Normal Operation Mode."

☞ page 13

- If you wish to adjust other parameters:

- 3 Simply press another parameter button: [WALL], [TIME], or [LEVEL].

Refer to "■Changing Wall Type."

☞ page 18

Refer to "■Adjusting Reverb Ambience Time."

☞ page 20

Refer to "■Adjusting Ambience Level."

☞ page 21

- If you wish to store the current settings in a user program 1 through 3:









Refer to "■Storing Your Settings as a User Program."

☞ page 22











## ■ Room Type List

### ● Rodgers Trillium series compatible Room Types

1-1	Room Type 1-1 Room		Room
1-2	Room Type 1-2 Stage		Stage
1-3	Room Type 1-3 Small Hall		Small Hall
1-4	Room Type 1-4 Medium Hall		Medium Hall
1-5	Room Type 1-5 Small Church		Small Church
1-6	Room Type 1-6 Medium Church		Medium Church
1-7	Room Type 1-7 Large Church		Large Church
1-8	Room Type 1-8 Cathedral		Cathedral

### ● Additional RSS-303 Room Types

2-1	Room Type 2-1 Small Box		Small Box
2-2	Room Type 2-2 Large Box		Large Box
2-3	Room Type 2-3 Cabin		Cabin
2-4	Room Type 2-4 Chamber		Chamber
2-5	Room Type 2-5 Studio		Studio
2-6	Room Type 2-6 Music Pub, Bar		Music Pub, Bar
2-7	Room Type 2-7 Large Hall		Large Hall
2-8	Room Type 2-8 Cosmic Space		Cosmic Space

## ■ Changing Wall Type

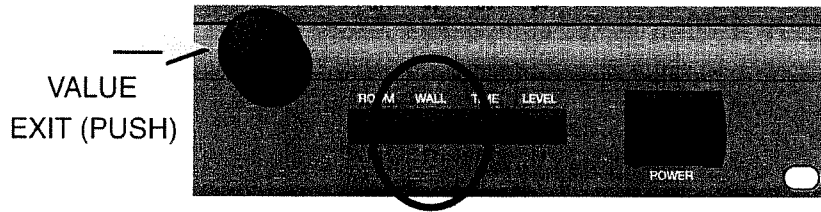

### ● Enter the mode where you can change the wall type.

- 1 Press the [WALL] button.

The following display appears.

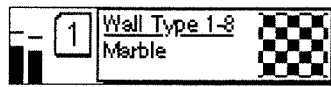

If the User Mode is set to 2, the settings are protected. The display indicates.

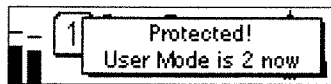

and it is not possible to change the wall type.



To change the User Mode, refer to  
“■Making Other Settings.”

☞ page 34

### ● Select Wall Type.

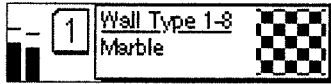

- 2 Rotate the [VALUE] knob to select the Wall Type.

There are a total of 16 wall type selections: 1.1 through 1.8 are compatible with the Trillium series of Rodgers organs, and 2.1 through 2.8 have been extended on the RSS-303 “■Wall Type List.” ☞ page 19



When you change the wall type, the ambience sound also changes immediately.

### ● Exit.

- To exit this mode:

- 3 Press the [EXIT] button.

The RSS-303 returns to “■Normal Operation Mode.”

☞ page 13

- If you wish to adjust other parameters:

- 3 Simply press another parameter button: [ROOM], [TIME], or [LEVEL].

Refer to “■Changing Room Type.”

☞ page 16

Refer to “■Adjusting Reverb Ambience Time.”

☞ page 20

Refer to “■Adjusting Ambience Level.”

☞ page 21









- If you wish to store the current settings in a user program 1 through 3:

Refer to “■Storing Your Settings as a User Program.”









☞ page 22

## ■ Wall Type List

### ● Rodgers Trillium series compatible types

1-1	Wall Type 1-1 Draspery		Drapery
1-2	Wall Type 1-2 Carpet		Carpet
1-3	Wall Type 1-3 Acoustic Tile		Acoustic Tile
1-4	Wall Type 1-4 Wood		Wood
1-5	Wall Type 1-5 Brick		Brick
1-6	Wall Type 1-6 Plaster		Plaster
1-7	Wall Type 1-7 Concrete Block		Concrete Block
1-8	Wall Type 1-8 Marble		Marble

### ● Additional RSS-303 Wall Types

2-1	Wall Type 2-1 Fiber glass		Fiberglass
2-2	Wall Type 2-2 Wood and Curtain		Wood Curtain
2-3	Wall Type 2-3 Wood and Paper		Wood Paper
2-4	Wall Type 2-4 Partition		Partition
2-5	Wall Type 2-5 Glass Plate		Glass Plate
2-6	Wall Type 2-6 Metal Plate		Metal Plate
2-7	Wall Type 2-7 Concrete		Concrete
2-8	Wall Type 2-8 Super Hard		Super Hard

---

## ■ Adjusting Reverb Ambience Time

---

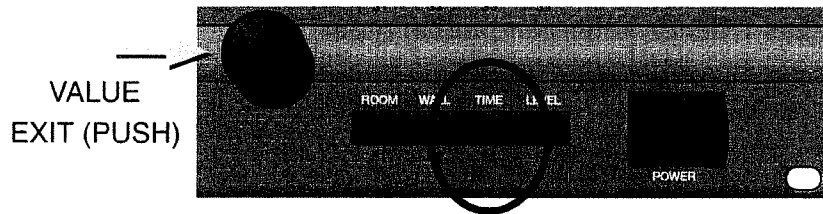

### ● Enter the adjustment mode for Reverb Time.

- 1 Press the [TIME] button.  
The following display appears.

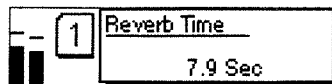

- 2 Rotate the [VALUE] knob to adjust reverb time.



The available range of reverb times depends on the room type and wall type.



If the User Mode is set to 2, the settings are protected. The display indicates:

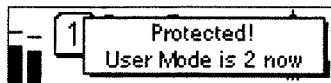

It is not possible to change the ambience sound reverb time.



To change the user mode, refer to "■Making Other Settings."

☞ page 34

### ● Exit.

○ To exit this mode:

- 3 Press the [EXIT] button.  
The RSS-303 returns to "■Normal Operation Mode."

☞ page 13

○ If you wish to adjust other parameters:

- 3 Simply press another parameter button: [ROOM], [WALL], or [LEVEL].

Refer to "■Changing Room Type."

☞ page 16

Refer to "■Changing Wall Type."

☞ page 18

Refer to "■Adjusting Ambience Level."

☞ page 21

○ If you wish to store the current settings in a user program 1 through 3:

Refer to "■Storing Your Settings as a User Program."

☞ page 22

## ■ Adjusting Ambience Level

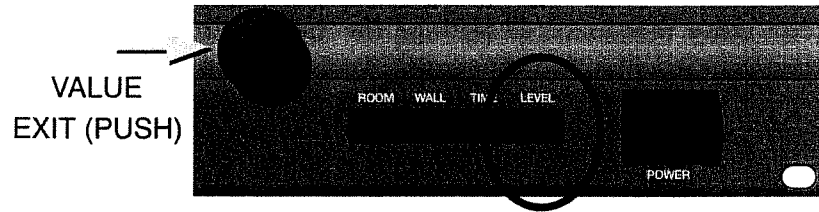

### ● Enter the mode where you can adjust the level.

- 1 Press the [LEVEL] button.  
The following display appears.

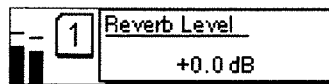

- 2 Rotate the [VALUE] knob to adjust the level.

**NOTE** By default, this is set to the optimal level for the room type or wall type.

**NOTE** 0.0 dB is the standard level, but you may adjust this as desired.

**?** User Mode is set to 2, the settings are protected. The display indicates:

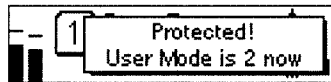

It is not possible to change the ambience sound level.

 To change the user mode, refer to "■Making Other Settings."

☞ page 34

### ● Exit.

- To exit this mode

- 3 Press the [EXIT] button.  
The RSS-303 returns to "■Normal Operation Mode."

☞ page 13

- If you wish to adjust other parameters:

- 3 Simply press another parameter button: [ROOM], [WALL], or [TIME].  
Refer to "■Changing Room Type." ☞ page 16  
Refer to "■Changing Wall Type." ☞ page 18  
Refer to "■Adjusting Reverb Ambience Time." ☞ page 20

- If you wish to store the current settings in a user program 1 through 3:

Refer to "■Storing Your Settings as a User Program." ☞ page 22

☞ page 22

---

## ■ Storing Your Settings as a User Program

---

- You can store three sets of settings for the ambience sound.

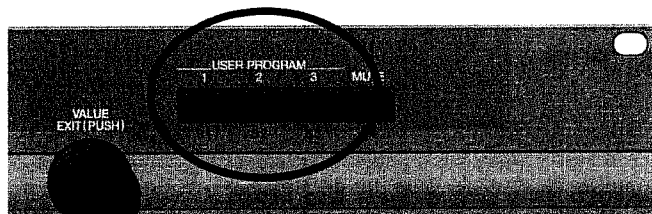

- 1 Press the user program button [1], [2], or [3] for the number in which you wish to store your settings and hold it for three seconds or longer.

- The display asks you to erase any settings that were stored in that user program and overwrite with new settings.

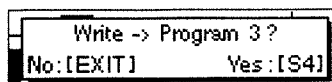

If the user mode is set to 1, the settings are protected. The display indicates:

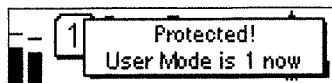

It is not possible to store the settings.



To change the user mode, refer to "■ Making Other Settings"

page 34

- If you are sure that you wish to write the settings to internal memory
  - 2 Press the [S4] button.

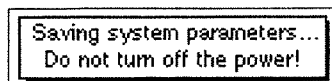

This display appears while the settings are written.



Never turn off the power switch while this display is shown. When the settings have been written, RSS-303 returns to the previous state.

- To cancel without writing
  - 2 Press the [EXIT] button.  
The RSS-303 returns to the previous state.

# Settings and Adjustments

## ■ About Field Settings

---

- **Make settings according to the particular reverberation of your location.**

Every location has its own characteristic reverberation. Even if the reverb time is identical, different halls or locations have dramatically differing reverberation; for example, the reverberation may be particularly long for high-frequency sounds, or there may be less low-frequency reverberation. When using the RSS-303 ambience system to produce the reverberation of a virtual space, the desired effect is achieved if you use the RSS-303 to add the difference between “desired reverberation” and “the reverberation unique to that space.” The RSS-303 contains models for the reverberation of various locations, and allows you to make settings simply by selecting the appropriate model.

- **To obtain the optimal reverberation, you must make settings according to the actual location of your speakers.**

The RSS-303 ambience system uses RSS technology to model rooms such as cathedrals, halls, and rooms. To obtain the optimal ambience sound, you must specify two values.

- 1 The distance from the sound source to the listener
- 2 The direction of the sound source

By making these settings, it is possible to create early reflections of the ambience sound that match the direction of the sound source. Also, the sound waves that travel through the air are correctly synchronized with the ambience sound that is added by the RSS-303.

- **When the unit is shipped from the factory, these settings are set to provisional values.**

When you use the RSS-303 for the first time, you must make these settings to obtain the optimal reverberation. You will also need to set these again when you change the conditions of the installed location, or when you transport the system to a new location.

---

## ■ Starting Setup

---

- The switch used to enter this mode is located behind the protective cover.

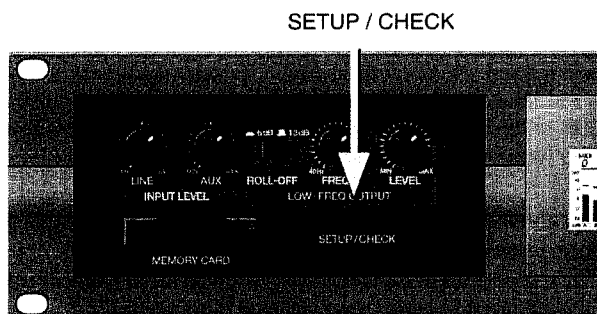

- 1 Remove the protective cover located at the left of the RSS-303 front panel.
- 2 Press the [SETUP/CHECK] button.

- Enter setup mode.

```
RSS-303 Ver. 1.00
Setup Mode - HELP: [S3]
Exit: [EXIT]      MENU: [S4]
```

- If you would like to see an explanation before you make the setting:

- 3 Select HELP. Press [S3].



For an explanation of the following operation, refer to "■Setup Help"

page 26

- To select a setting item:

- 3 Select MENU. Press [S4].



For an explanation of the following step, refer to "■Setup Menu"

page 27

- To return to normal operating mode:

Refer to "■Finishing Setup."

page 25



## ■ Finishing Setup

Here's how to finish the setup.

```

RSS-303 Ver. 1.00
Setup Mode - HELP:[S3]
Exit:[EXIT]      MENU:[S4]
  
```

- 1 Select Exit. Press [EXIT].
  - If you did not change anything, the display indicates:

```

Return to
Operation Mode
Any change wasn't saved
  
```

RSS-303 returns to normal operating mode.



For subsequent operation, refer to  
“■Normal Operation Mode.”

page 13

- If you modified settings in Setup mode, the display indicates:

```

Save setup parameters?
Cancel:[EXIT]
Don't SAVE:[S1]  SAVE:[S4]
  
```

asking whether you wish to save the settings in memory.



If you save the settings, these are selected the next time you turn the power on.



If you do not save the settings, any changes are discarded when you turn off the power.

- To quit without saving
  - 2 Select “Don't SAVE.” Press [S1].



The settings remain in effect until the power is turned off.



Once the power has been turned off, the RSS-303 returns to the previously-saved state the next time the power is turned on.

- To save the settings in memory
  - 2 Select SAVE. Press [S4].

The RSS-303 saves the settings.

```

Saving system parameters...
Do not turn off the power!
  
```



Do not turn off the power switch while this screen is displayed.  
When saving is completed, the screen indicates:

```

Return to
Operation Mode
Changes was saved
  
```

The RSS-303 returns to normal operating mode.



For subsequent operation, refer to  
“■Normal Operation Mode.”

page 13

---

## ■ Setup Help

---

Simple help screens continue from here.

Show Instruction?  
Skip: Push [S3] button!  
Show: Push [S4] button!

- 1 Press [S4].

### ● Changing a value

Set value/mode using [VALUE]  
then go to next page  
Push [S4] button!

This explains that a value or mode can be set by rotating the [VALUE] knob.

- 2 Press [S4].

### ● Advancing or returning through pages

You can move the page to...  
Next (→) using [S4]  
Previous (←) using [S1]

This explains that in general, you press [S4] to advance to the next page.  
If it is possible to press [S4] to advance to the next page, an “->” is displayed in the screen.  
This also explains that in general, you press [S1] to return.

- 3 Press [S4].

### ● Exiting the settings

Press [EXIT] in any page  
to cancel setup  
[S1]← →[S4]

This explains that you can press [EXIT] to exit from the settings page.

- 4 Press [S4].

### ● Enter connection check mode?

Now ready to begin!  
Check Connection?  
[S1]← Skip:[S3] Yes:[S4]



In connection check mode, an audio signal is output from the RSS-303 for checking purposes.  
Before continuing to the next step, check the volume of your amp so that an excessive volume is not produced.

- To check the connections

- 5 Press [S4].



For subsequent steps, refer to  
“■Checking Connections.”

page 28

- To proceed to the next page

- 5 Press [S3].

### ● Make field settings?

Now ready to begin!  
Field Setup?  
[S1]← Skip:[S3] Yes:[S4]

- To make essential settings:

- 6 Press [S4].



For an explanation of subsequent steps, refer to  
“■Making Field Settings.”

☞ page 31

- To proceed to the next page:

- 6 Press [S3].

### ● Make other settings?

Now ready to begin!  
Other Setup?  
[S1]← Skip:[S3] Yes:[S4]

- To make other settings:

- 7 Press [S4].



For an explanation of subsequent steps, refer to  
“■Making Other Settings”

☞ page 34

- To proceed to the next page:

- 7 Press [S3].

The RSS-303 returns to the setup mode initial screen.

## ■ Setup Menu

Check Connection:[S1]  
Field Setup:[S2]  
Other Setup:[S3] / Audio:[S4]

- To check connections

- 1 Select Check Connection. Press [S1].



For an explanation of subsequent steps, refer to  
“■Checking Connections.”

☞ page 28

- To make field settings

- 1 Select Field Setup. Press [S2].



For an explanation of subsequent steps, refer to  
“■Making Field Settings.”

☞ page 31

- To make other settings

- 1 Select Other Setup. Press [S3].



For an explanation of subsequent steps, refer to  
“■Making Other Settings.”

☞ page 34

- To jump directly to audio setup pages (e.g. EQ) in the other settings.

- 1 Select Audio. Press [S4].



For an explanation of subsequent steps, refer to  
“■Making Other Settings.”

☞ page 34

## ■ Checking Connections



How do I enter this mode?  
Refer to "■ Starting Setup."

page 24

### ● Here begins a series of checking operations.

OK to check connection?	
No: [EXIT]	Start: [S4]

An audio signal is output from the front and rear to indicate that the RSS-303 has entered connection check mode.

Check speaker volume.

In connection check mode, test audio is assigned to [S2] and [S3].

To play the test audio, press [S2] or [S3].

Turn input level adjustment knobs all the way down.



If you want to perform the check using another sound, input an audio signal from the LINE/AUX inputs, and adjust the input level.

- 1 Press [S4].

### ● First, check whether each output channel is connected correctly.

First, from the front L channel

Check Channel	■0	□
Sound: [S2]	Front L	
[S1]←	→[S4]	□ □

- To play the built-in test audio

- 2 Press [S2] or [S3].

### ● Listen.

- 3 Determine which speaker produces the sound.

If the sound comes from the Front L-channel, the connection is OK.

If the sound comes from another location, check the connection cables.

- 4 Press [S4].

### ● Next, check the front R channel.

Check Channel	□	0■
Sound: [S2]	Front R	
[S1]←	→[S4]	□ □

- To play the built-in test audio

- 5 Press [S2] or [S3].

### ● Listen.

- 6 Determine which speaker produces the sound.

If the sound comes from the Front R-channel, the connection is OK.

If the sound comes from another location, check the connection cables.

- 7 Press [S4].

### ● Next is the rear L channel.

Check Channel	□	□
Sound: [S2]	Rear L	
[S1]←	→[S4]	■0 □

● **Listen.**

- 8 Determine which speaker produces the sound.  
If the sound comes from the Rear L-channel, the connection is OK.
- 9 Press [S4].

● **Next is the rear R channel.**

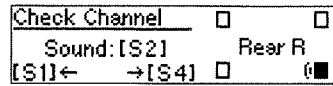

● **Listen.**

- 10 Determine which speaker produces the sound.  
If the sound comes from the Rear R-channel, the connection is OK.
- 11 Press [S4].

● **Next is the phase check. First, check the front.**

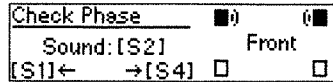

● **Play an internal test tone.**

- 12 Press [S3].  
Pink noise is sounded for the phase check.

● **Listen.**

- 13 Stand facing the front exactly between the two speakers and listen.  
If the sound appears to be located exactly in front of you, the connection is OK.



If the sound appears to be coming from inside your head or if you cannot tell where the sound is coming from, it is possible that the positive/negative connections to one of the speakers are reversed. Check the wiring.  
Alternatively, it is possible that the phase is being reversed inside an amp or a connection cable. Check these points.

- 14 Press [S4].

● **Next, check the phase between front and rear L channels.**

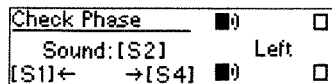

- 15 Press [S3].

● **Listen.**

- 16 Stand facing the left exactly between the two speakers and listen.  
If the sound appears to be positioned exactly in front of you, the connection is OK. If not, check the connections.
- 17 Press [S4].

● Next, check the phase between front and rear R channels.

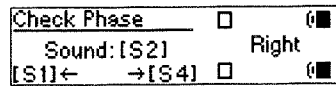

- 18 In the same way, face the right, press [S3], and check whether the phase is correct.
- 19 Press [S4].

● Next, check the rear LR phase.

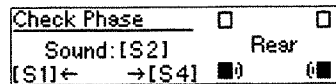

- 20 In the same way, face the rear, press [S3], and check whether the phase is correct.
- 21 Press [S4].

● Finally, check the volume balance of all speakers.

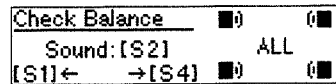

- 22 Press [S3].

● Listen.

- 23 If the test tone is output at the same volume from all four speakers, the result is OK.
- 24 Press [S4].

● This completes the connection check.

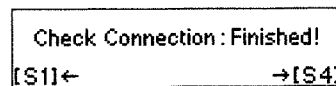

- If you wish to perform the check process once again
  - 25 Press [S4].
- The RSS-303 returns to the "□1" display page.
- To exit the check process
  - 26 Press [EXIT].



● **Specify the distance between the left and right speakers.**

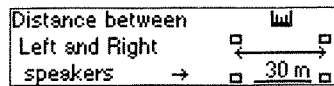

- 7 Rotate the [VALUE] knob to specify the actual distance.
- 8 Press [S4].

● **Specify the direction and distance of the sound source.**

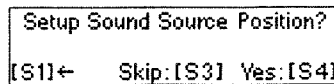

- 9 Press [S3].  
If you press [S4], this item is skipped and the RSS-303 returns to the first page of the field settings.

● **Specify the distance to sound source A from the center of the area that is bounded by the four speakers, front and rear.**

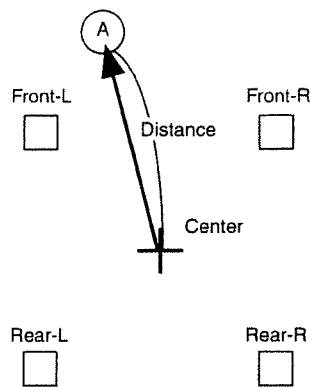

By the location of sound source A, we mean the playback location of the direct sound that is sent through the connection to input A of the RSS-303.  
In other words, this is the location of the playback speakers or the pipes of a pipe organ.

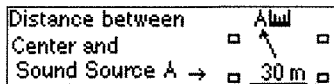

- 10 Rotate the [VALUE] knob to specify the distance.
- 11 Press [S4].



- **Specify the direction of sound source A, as seen from the center of the area bounded by the four speakers.**

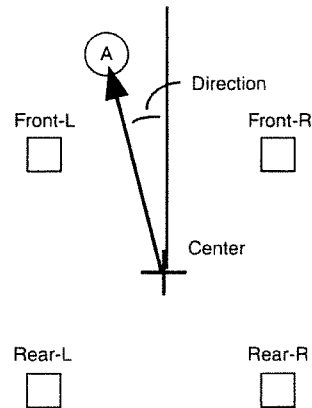

Front is 0 degrees. A rotation toward the left of up to 180 degrees is indicated as 0-L180. For example, if you are setting the direction to "left 30 degrees," you would make the display read "L30." If the direction is toward the right, you would make the display read (for example) "R30."

- 11 Rotate the [VALUE] knob to specify the direction.
- 12 Press [S4].

- **Specify the distance to sound source B.**

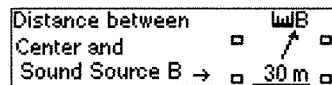

- 13 Rotate the [VALUE] knob to specify the distance from the center of the area to sound source B.
- 14 Press [S4].

- **Finally, specify the direction of sound source B.**

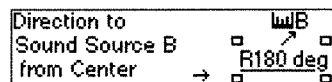

Front is 0 degrees, and rotation of up to 180 degrees toward the right is displayed as 0-R180. For example if you are setting the direction to "right 30 degrees," you would make the display read "R30."

- 15 Rotate the [VALUE] knob to specify the direction.
- 16 Press [S4].

- **The field settings have been finished.**

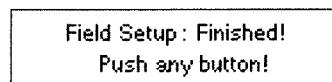

- 17 Press any button.

- **This completes the field settings.**

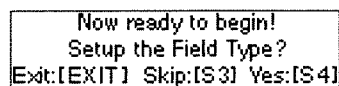

- 18 Press [EXIT].



For the subsequent steps, refer to "■Finishing Setup."

page 25

## ■ Making Other Settings

● Use the settings described here in the following cases.

- When you wish to change the User Mode
- When you wish to use the equalizer to compensate for speaker characteristics or irregularities in the acoustics of your location
- When you wish to turn the front and rear output high-pass filter on/off
- When you wish to make a backup of the internal settings on a memory card
- When you wish to load settings from a memory card into internal memory
- When you wish to adjust the contrast of the LCD screen
- When you use more RSS-303 units and would like to change the Device ID

● Select the item that you wish to set.

Other setup			
System	File	Audio	Help
[S1]	[S2]	[S3]	[S4]

- To exit this mode and return to normal operating mode:

- 1 Press [EXIT].



For subsequent steps, refer to "■Finishing Setup."

☞ page 25

- When to set the following items?

- When you wish to change the user mode
- When you wish to set the device ID
- When you wish to adjust the contrast of the LCD screen
- When you wish to restore the factory settings

Other setup			
System	File	Audio	Help
[S1]	[S2]	[S3]	[S4]

- 1 Select System. Press [S1].

● Select the item that you wish to set.

Other setup / System			
User	Device	LCD	Reset
[S1]	[S2]	[S3]	[S4]

- To change the user mode

- 2 Select User. Press [S1].



For the subsequent steps, refer to "■User Mode Settings."

☞ page 36

- To set the device ID

- 2 Select Device. Press [S2].



For the subsequent steps, refer to "■Device ID Settings."

☞ page 37

- To adjust the contrast of the LCD screen

- 2 Select LCD. Press [S3].



For the subsequent steps, refer to "■LCD Screen Contrast."

☞ page 37

- To restore the factory settings

- 2 Press Reset. Press [S4].



For the subsequent steps, refer to "■Factory Settings."

☞ page 38

- Using the following operations
  - Loading a set of parameters from a memory card
  - Saving a set of parameters to a memory card

Other setup			
System	File	Audio	Help
[S1]	[S2]	[S3]	[S4]

- 1 Select File. Press [S2].

● **Select the item that you wish to set.**

Other setup / File	
Load	Save
[S1]	[S2]

- To load a set of parameters from a memory card

- 2 Select Load. Press [S1].



For subsequent steps, refer to  
"■Loading All Parameters."

page 39

- To save a set of parameters to a memory card

- 2 Select Save. Press [S2].



For subsequent steps, refer to  
"■Saving All Parameters."

page 40

- To perform the following operations

- Compensating for speaker response or acoustical irregularities of the playback location
- Inserting a high-pass filter into the front and rear outputs
- Adjusting front and rear output level

Other setup			
System	File	Audio	Help
[S1]	[S2]	[S3]	[S4]

- 1 Select Audio. Press [S3].

● **Select the item that you wish to set.**

Other setup / Audio			
EQ	Hi-Pass	Output	
[S1]	[S2]	[S3]	[S4]

- To compensate for speaker response or acoustical irregularities of the playback location

- 2 Select EQ. Press [S1].



For subsequent steps, refer to  
"■Compensating for Speaker Response and Playback Location Acoustic Irregularities."

page 41

- To insert a high pass filter into the front and rear outputs

- 2 Select Hi-Pass. Press [S2].



For subsequent steps, refer to  
"■Output High-pass Filter."

page 42

- To adjust the front and rear output level

- 2 Select Output. Press [S3].



For subsequent steps, refer to  
"■Output Level Adjustment."

page 42

---

## ■ User Mode Settings

---

When you enter this mode, the currently selected mode is displayed.

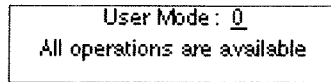

User mode 0 is the mode in which all operations are permitted.

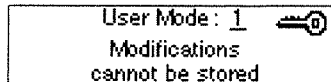

In user mode 1, you can select user programs and edit them, but you cannot store the edited settings as a user program.

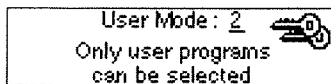

In user mode 2, you can only select the already-stored user programs.

### ● Change the user mode

- 1 Rotate the [VALUE] knob to select the user mode.

### ● Exit this mode.

- 2 Press [EXIT]. The RSS-303 returns to the following page:

Other setup / System			
User	Device	LCD	Reset
[S1]	[S2]	[S3]	[S4]

## ■ Device ID Settings

When using two or more RSS-303 units, you must set a device ID for each one to distinguish them from each other. The reverberation pattern also changes with the device ID.

- **Each RSS-303 must be assigned a unique number within the system.**

Assign a unique Device ID if multipul RSS-303 will be used [S4] →
---

- 1 Press [S4].

- **Select Device ID as the setting item.**

Device ID and Master/Slave			
←	16	+	Slave
Device ID : [F1]			Master : [F3]

- 2 Press [F1].

- **Specify the device ID number.**

- 3 Rotate the [VALUE] knob to specify the number.

Any number may be used as long as it does not match the number of another RSS-303 in the system, but if there is only one RSS-303, it is best to leave this set to 1.

If you are using multiple RSS-303 units, set their device ID numbers in sequence: 1, 2, 3, etc.

- **Select Master/Slave as the setting item.**

Device ID and Master/Slave			
	16	+	Slave
Device ID : [F1]			Master : [F3]

- 4 Press [F3].

- **If you are using two or more RSS-303 units, set one of them as the Master.**

The RSS-303 at the beginning of the MIDI chain will be the master.

- 5 Rotate the [VALUE] knob to select either Master or Slave.

- **Complete this setting.**

- 6 Press [EXIT]. The RSS-303 returns to the following page:

Other setup / System			
User	Device	LCD	Reset
[S1]	[S2]	[S3]	[S4]

## ■ LCD Screen Contrast

- **Adjust the contrast setting.**

- 1 Rotate the [VALUE] knob to adjust the contrast.

LCD Contrast
_ 5

- **Exit this mode.**

- 2 Press [EXIT]. The RSS-303 returns to the following page:

Other setup / System			
User	Device	LCD	Reset
[S1]	[S2]	[S3]	[S4]

- 3 Press [EXIT].

Other setup			
System	File	Audio	Help
[S1]	[S2]	[S3]	[S4]

The RSS-303 returns to the “■ Making Other Settings” page.

☞ page 34

---

## ■ Factory Settings

---

● **Restore all parameters to factory settings.**

Reset all parameters to factory preset? No:[EXIT]      Yes:[S4]
---

○ If you decide not to perform this operation

- 1 Select No. Press [EXIT]. The RSS-303 returns to the following page:

Other setup / System			
User	Device	LCD	Reset
[S1]	[S2]	[S3]	[S4]

○ If you want to restore all parameters to the factory settings

- 1 Select Yes. Press [S4].

The display shows:

Saving system parameters... Do not turn off the power!
---

to indicate that the settings are now being restored.  
Never turn off the power while this screen is displayed.  
After a time, the display shows:

Function completed! Push any button!
---

to indicate that all parameters are restored to factory settings.

- 2 Press any button. The RSS-303 returns to the following page:

Other setup / System			
User	Device	LCD	Reset
[S1]	[S2]	[S3]	[S4]

## ■ Loading All Parameters

- Here's how to load all parameters from a memory card.

Load All from Memory Card?	
No:[EXIT]	Yes:[S4]

- If you decide not to load

- 1 Select No. Press [EXIT]. The RSS-303 returns to the following screen:

Other setup / File	
Load	Save
[S1]	[S2]

- To load the parameters

- 1 Insert a memory card. The gold contacts must face downward.

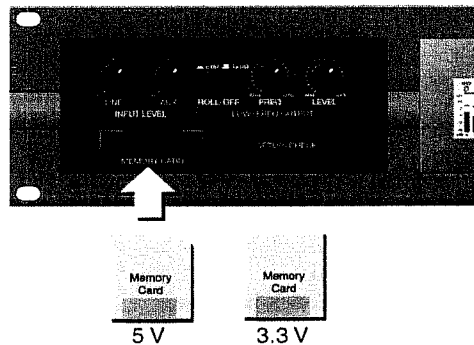

- 2 Select Yes. Press [S4]. The display shows:

<p>Loading parameters .. Do not turn off the power!</p>
---

to indicate that the settings are being loaded into internal memory.  
Never turn off the power while this screen is displayed.  
After a time, the display shows:

<p>Function completed! Push any button!</p>
---

to indicate that loading has been completed.



If the data could not be loaded correctly from the card, the display indicates:

<p>Error occurred! Card must be damaged Push any button!</p>
--

Make sure that the card is inserted correctly.

- 3 Press any button. The RSS-303 returns to the following page:

Other setup / File	
Load	Save
[S1]	[S2]

---

## ■ Saving All Parameters

---

● Here's how to save all parameters to a memory card.



The status of parameters as stored in the unit's internal memory is saved on memory card. If you've edited any of the system parameters, save your settings in internal memory first, then save them onto the card. See "■ Finishing Setup." FR page 25



○ If you decide not to perform the operation:

- 1 Select No. Press [EXIT]. The RSS-303 returns to the following screen:

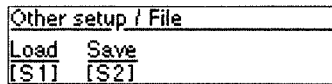

○ To save:

- 1 Insert a memory card. The gold contacts must face downward.
- 2 Select Yes. Press [S4]. The display shows:

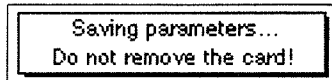

to indicate that the parameters are being saved.  
Never remove the memory card while this screen is displayed.  
After a time, the display shows:

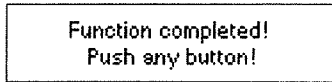

to indicate that the parameters have been saved.

- 3 Press any button. The RSS-303 returns to the following screen:

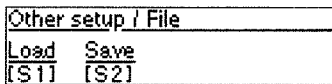

If there is a problem with the card and saving is not possible, the following display appears:

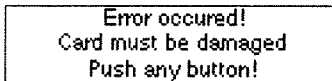

- 4 Press any button. You will return to the following page:

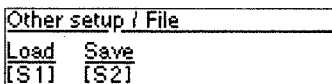

Exchange the faulty memory card for a new one and try the operation again.



## ■ Compensating for Speaker Response and Playback Location Acoustic Irregularities

### ● The RSS-303 provides a three-band parametric equalizer for the following purposes.

- Mainly to cancel out irregularities in speaker response.
- To mitigate acoustical idiosyncrasies in the room or hall where the sound is being played

Here we describe an actual adjustment procedure to explain the procedure.

In reality, these adjustments could be made in other ways. The explanation below is just one such procedure.

### ● Begin the adjustment.

EQ	Band 1	: [S1]	[S2]	[S3]
+3.3 kHz	12/12 Oct			+12.0 dB
Freq: [F1]	Width: [F2]			Gain: [F4]

### ● Select the EQ band.

- For Band 1
  - 1 Press [S1].
- For Band 2
  - 1 Press [S2].
- For Band 3
  - 1 Press [S3].

### ● Set the gain in the range of +3 to +6 dB to emphasize the point of uneven response as we search for it.

- 2 Select Gain. Press the [F4] button.

EQ	Band 1	: [S1]	[S2]	[S3]
3.3 kHz	+12/12 Oct			+12.0 dB
Freq: [F1]	Width: [F2]			Gain: [F4]

- 3 Rotate the [VALUE] knob to raise the gain into the range of +3 to +6 dB.

### ● Produce sound.

- 4 Input an audio signal into the input.

### ● Change the frequency and search for the frequency at which the uneven response is emphasized.

- 5 Select Freq. Press the [F1] button.

EQ	Band 1	: [S1]	[S2]	[S3]
+3.3 kHz	12/12 Oct			+12.0 dB
Freq: [F1]	Width: [F2]			Gain: [F4]

- 6 Search while rotating the [VALUE] knob.

### ● Turn down the gain until the unevenness disappears.

- 7 Select Gain. Press the [F4] button.

EQ	Band 1	: [S1]	[S2]	[S3]
3.3 kHz	+12/12 Oct			+12.0 dB
Freq: [F1]	Width: [F2]			Gain: [F4]

- 8 Rotate the [VALUE] knob to make adjustments.

### ● Adjust the bandwidth to the width of the unevenness.

- 9 Select Width. Press the [F2] button.

EQ	Band 1	: [S1]	[S2]	[S3]
3.3 kHz	+12/12 Oct			+12.0 dB
Freq: [F1]	Width: [F2]			Gain: [F4]

- 10 As you listen, rotate the [VALUE] knob to zero in on the correct setting.

### ● Select the next step.

- To use other bands to reduce other acoustical irregularities
  - 11 Repeat the same procedure from "1."

- To end this procedure
  - 11 Press [EXIT]. The RSS-303 returns to:

Other setup / Audio			
EQ	Hi-Pass	Output	
[S1]	[S2]	[S3]	[S4]

## ■ Output High-pass Filter

### ● Applications of the high-pass filter

In situations where you are not able to use very large speakers for the front and rear channels, turn on the high-pass filter. The ambience sound of an organ contains large amounts of low frequency. If low frequencies produce distortion in the speakers, we recommend that you turn on the 100 Hz high-pass filter. Conversely, if your speakers are capable of reproducing the low frequencies, we recommend that you do not use the high-pass filter.

### ● Front output high-pass filter

High Pass Filter (100 Hz)			
+	ON	-	OFF
Front:[F1]		Rear:[F3]	

- 1 Select Front. Press [F1].
- 2 Rotate the [VALUE] knob to select either On or Bypass.

### ● Rear output high-pass filter

High Pass Filter (100 Hz)			
-	ON	+	OFF
Front:[F1]		Rear:[F3]	

- 3 Select Rear. Press [F3].
- 4 Rotate the [VALUE] knob to select either On or Bypass.

### ● Exit this mode.

- 2 Press [EXIT]. The RSS-303 returns to:

Other setup / Audio			
EQ	Hi-Pass	Output	
[S1]	[S2]	[S3]	[S4]

## ■ Output Level Adjustment

### ● Perform this adjustment when you need to adjust the balance between the front and rear.

### ● Adjusting the front level

Output Level			
+	0 dB	-	0 dB
Front:[F1]		Rear:[F3]	

- 1 Select Front. Press [F1].
- 2 Rotate the [VALUE] knob to adjust the level.  
Normally you leave this at 0 dB, but you may increase or decrease it as necessary.

### ● Adjusting the rear level

Output Level			
-	0 dB	+	0 dB
Front:[F1]		Rear:[F3]	

- 1 Select Rear. Press [F3].
- 2 Rotate the [VALUE] knob to adjust the level.  
Normally you leave this at 0 dB, but you may increase or decrease it as necessary.

# Input/Output, Setting Switches and Volumes

## ■ The RSS-303's Inputs

- The RSS-303 has two sets of audio inputs.

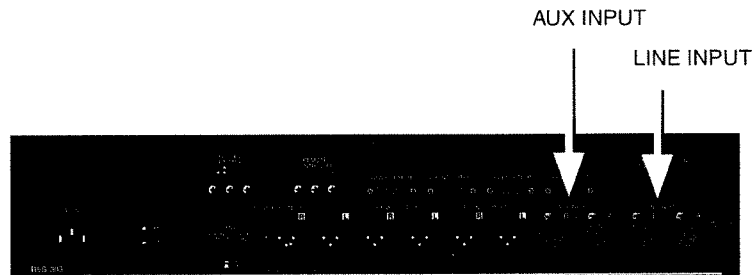

### ● LINE INPUT

- Connect these to the LINE OUT jacks of the organ or other sound source to which you wish to apply reverb.

### ● AUX INPUT

- Use these as supplementary inputs for other simultaneously used sound sources.
- Alternatively, they can input sound that was collected by a microphone.



The audio signals that are input to [LINE INPUT] and [AUX INPUT] are adjusted by the respective input volume and mixed before being processed to create the ambience sound.



For details on connections, refer to "■ System Configuration."

page 49

## ■ Adjusting the RSS-303 Input Level

### ● LINE INPUT

Adjust the level using the INPUT LEVEL [LINE] knob located behind the protective cover on the front panel.

### ● AUX INPUT

Adjust the level using the INPUT LEVEL [AUX] knob located behind the protective cover on the front panel.

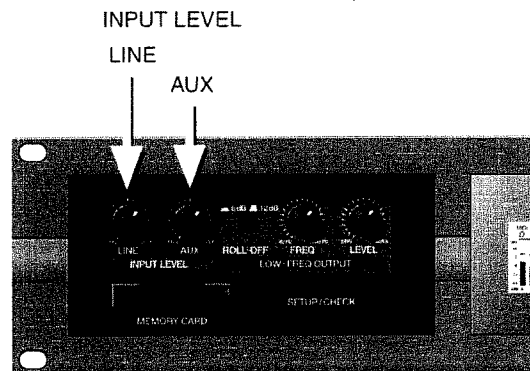

---

## ■ The RSS-303's Outputs

---

- The RSS-303 has three sets of audio outputs.

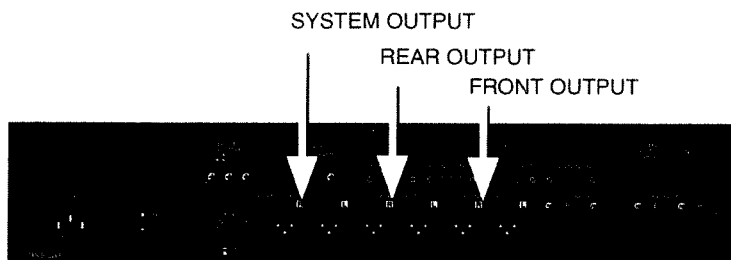

- **FRONT OUT**

- These outputs are for the front two of the four speakers that reproduce the ambience sound.

- **REAR OUT**

- These outputs are for the back two of the four speakers that reproduce the ambience sound.

- **SYSTEM OUT**

- You can mix this output signal depending on how you are using the RSS-303.
- Low frequency portion of the ambience sound
  - An output for reinforcing the low frequency portion of the reverberation.
- Mix the front output
  - Use this when you do not use front speakers for the ambience sound, and wish to mix the ambience into the speakers of the sound source.
- Mix the AUX inputs
  - Use this when you bypass the direct sound, or when using multiple RSS-303 units.

 For details, refer to  
"■[SYSTEM OUTPUT] Settings."

☞ page 45

 For details on connections, refer to  
"■System Configuration."

☞ page 49

## ■ [SYSTEM OUTPUT] Settings

As appropriate for the configuration of your system, you can mix the following three audio signals for output from these jacks.

### ● Low frequency portion of the ambience sound

To adjust the level, use LOW-FREQ OUTPUT [LEVEL] knob located behind the protective cover on the front panel.



For details on low frequency output settings, refer to “■Low Frequency Output Adjustment.”

☞ page 46

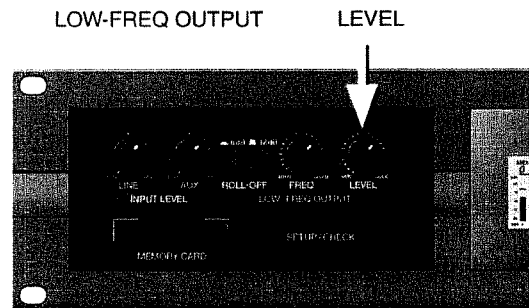

The level of Low Frequency output depends on the Rear Output Level.



For details, refer to “■Output Level Adjustment.”

☞ page 42

### ● FRONT OUTPUT

This is mixed if you turn on the MIX [FRONT OUTPUT] switch located in the SYSTEM OUTPUT section of the rear panel.

### ● AUX INPUT

This is mixed if you turn on the MIX [AUX INPUT] switch located in the SYSTEM OUTPUT section of the rear panel.

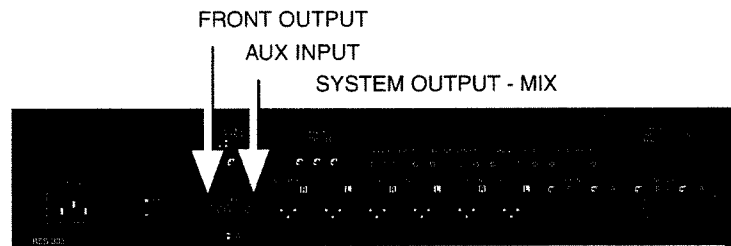

## ■ Low Frequency Output Adjustment

### ● Adjusting the low-pass filter cutoff frequency

To adjust the cutoff frequency, use the LOW-FREQ OUTPUT [FREQ] knob located behind the protective cover on the front panel.

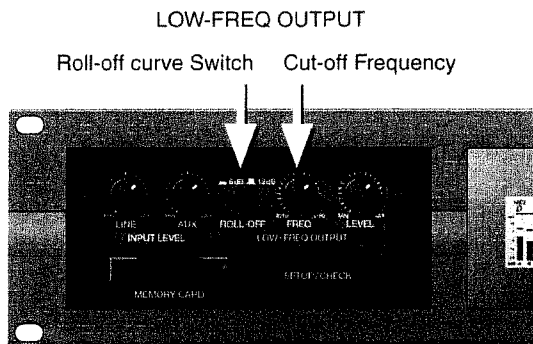

### ● Switching the roll-off curve of the low pass filter

To switch the roll-off curve, use the LOW-FREQ OUTPUT [ROLL-OFF] button located behind the protective cover on the front panel. You can select either 6 dB/octave or 12 dB/octave.

### ● Adjusting the low-frequency output level

To adjust the level, use the LOW-FREQ OUTPUT [LEVEL] knob located behind the protective cover on the front panel.

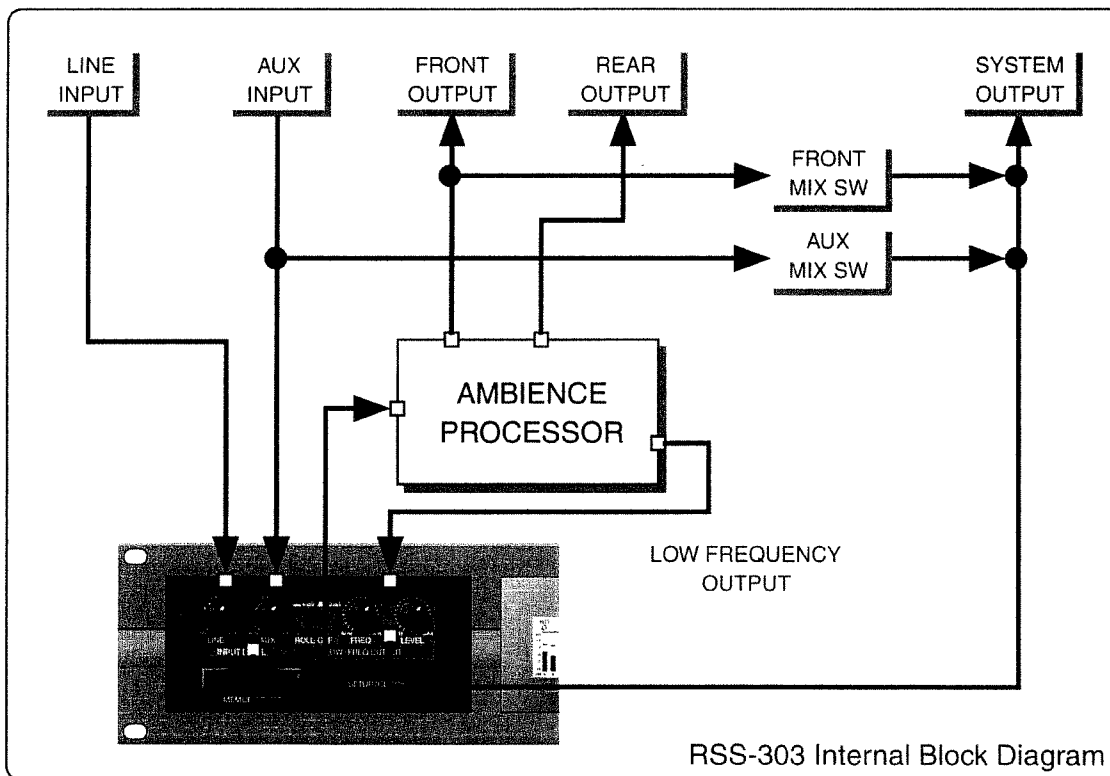

## ■ Controlling the Power

- **There are two ways to control RSS-303 power.**

- To turn the power on/off for the RSS-303 alone  
Refer to "■Controlling the Power Locally."
- To control the power of the entire system from the power switch of the Rodgers organ  
Refer to "■Remotely Controlling Power."

## ■ Remotely Controlling Power

- **Allow the power switch of the Rodgers organ to turn the power on/off for the entire system.**

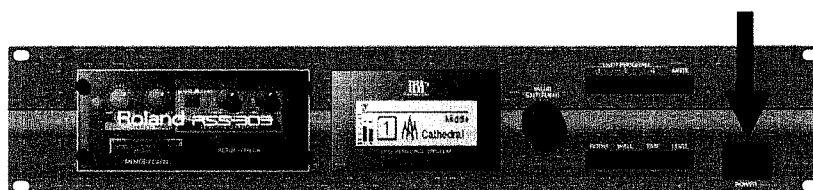

- 1 Leave the RSS-303 front panel power switch on.

- **Allow the power of the RSS-303 to be controlled remotely.**

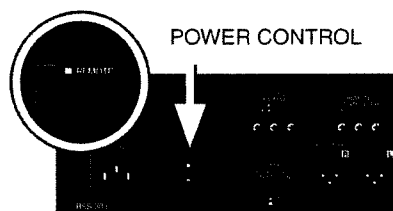

- 2 Set the rear panel REMOTE/LOCAL switch to the [REMOTE] position.

**NOTE** Use the Rodgers organ power switch to turn the power on/off.

## ■ Connection via the Special Cable to the Rodgers Organ

- **The four D-SUB connectors are for connection to the Rodgers organ.**
- **The no-voltage make/break contacts are used to control an external power distributor.**

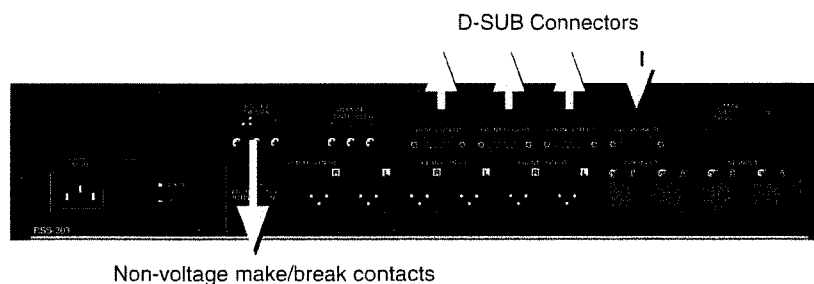

For details on connection methods  
Refer to "■Contact Points for Rodgers Organs."

page 59

---

## ■ Controlling the Power Locally

---

- Allow the power switch to turn on/off only the RSS-303.

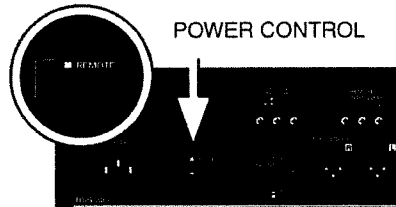

- 1 Set the rear panel REMOTE/LOCAL switch to the [LOCAL] position.



To turn the power on/off, use the power switch located on the RSS-303 front panel.

---

## ■ Connecting the Remote Controller

---

A cable with tabs at the end is attached to the remote controller. Use screws to attach these tabs to the [REMOTE CONTROLLER] connectors on the rear panel of the RSS-303.

- 1 Match the cable colors with the connector numbers.
  - [1] - White
  - [2] - Black
  - [3] - Shield

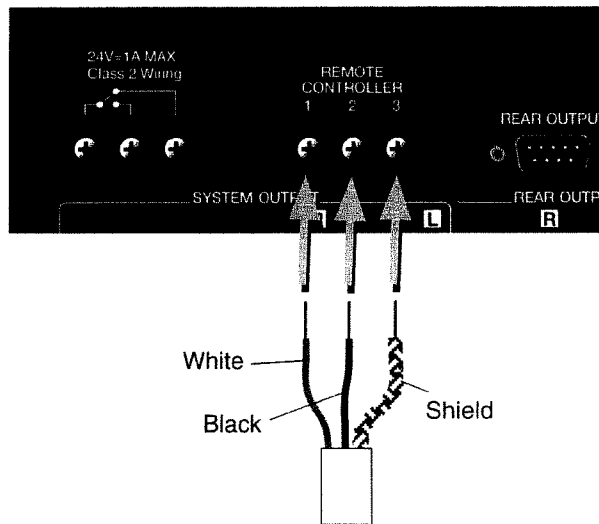



# System Configuration

## ■ Speaker Placement and Connections for a Basic System

### ● Speaker placement

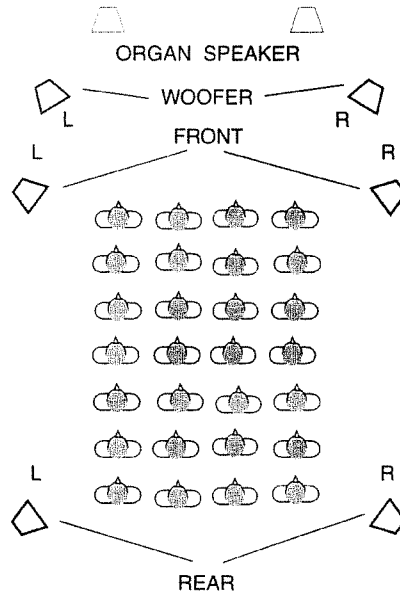

- ❑ 1 You will need four channels of amplifiers and four speakers.

If the system is intended for an audience of several hundred people, you should use amps and speakers of 100 watts or greater.

Use speakers whose directional characteristics are as wide as possible.

- ❑ 2 Place the speakers.

When using the RSS-303 ambience system, you should generally place the four speakers so they surround the audience.

As a rule, each speaker should be pointed so it faces the audience.

### ● Connections between the RSS-303, amps, and organ

- Take the output from the RSS-303's [FRONT OUTPUT] and [REAR OUTPUT].
- Connect the output of the organ to [LINE INPUT].

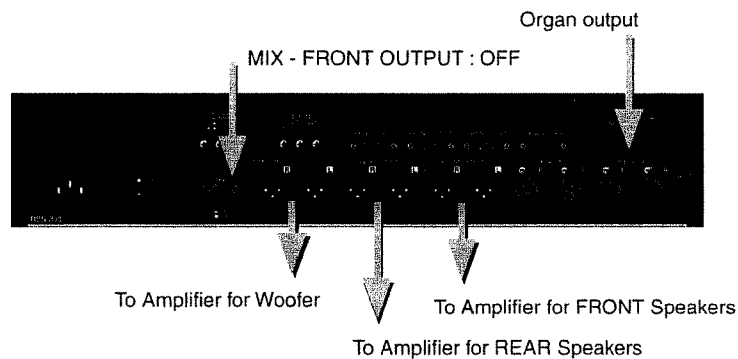

- ❑ 3 Make connections.
- ❑ 4 Turn off the [MIX-FRONT OUTPUT].
- ❑ 5 Connect [SYSTEM OUTPUT] to a dedicated low-frequency amp/speaker.

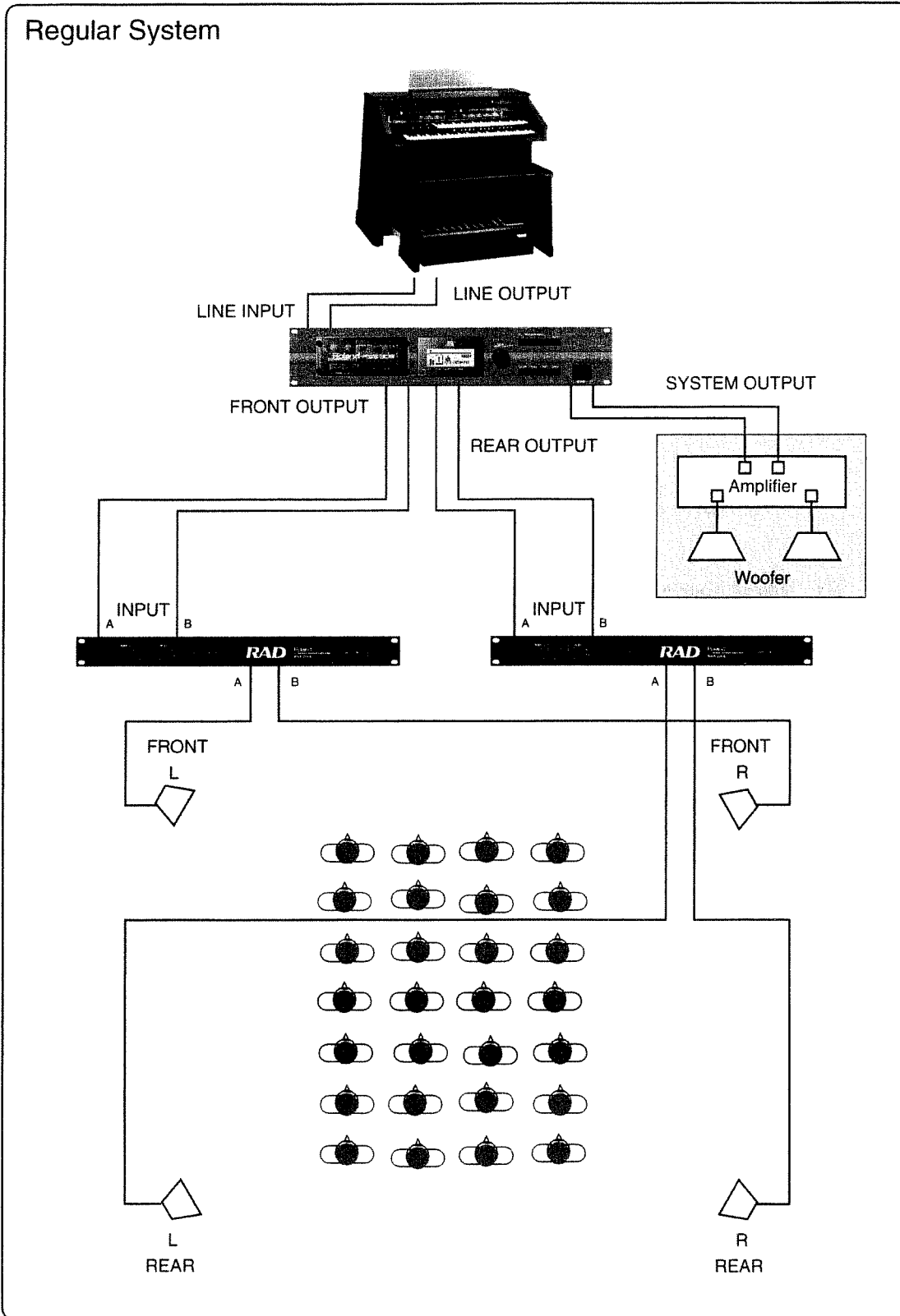

## ■ Speaker Placement and Connections for a Simple System

The dedicated front speakers are omitted, and the organ speakers used in their place.

### ● Speaker placement

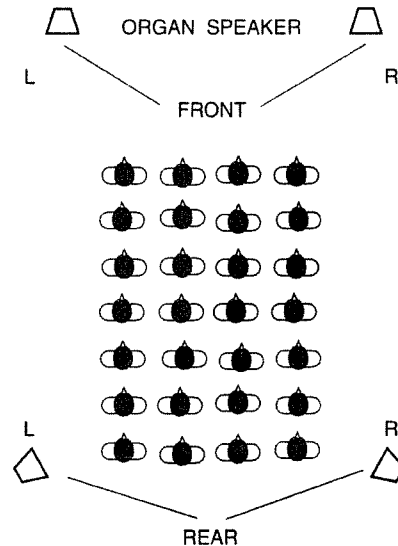

- 1 You will need two channels of amplifiers and two speakers.

If the system is intended for an audience of several hundred people, you should use amps and speakers of 100 watts or greater.

Use speakers whose directional characteristics are as wide as possible.

- 2 Place the speakers.

Place the two speakers pointing at the rear audience.

### ● Connections between the RSS-303, amps, and organ

- Take the output from the RSS-303's [SYSTEM OUTPUT] and [REAR OUTPUT].
- Connect the output of the organ to [LINE INPUT].

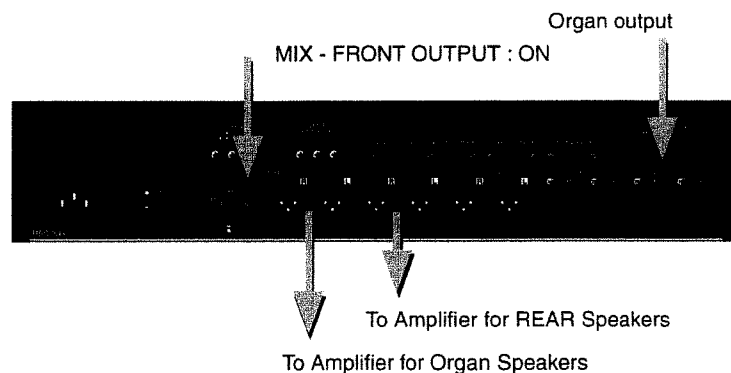

- Connect [REAR OUTPUT] to the rear amps.
- Mix [SYSTEM OUTPUT] into the main amp of the organ itself.

- 3 Make connections.
- 4 Turn on the [MIX - FRONT OUTPUT] switch.

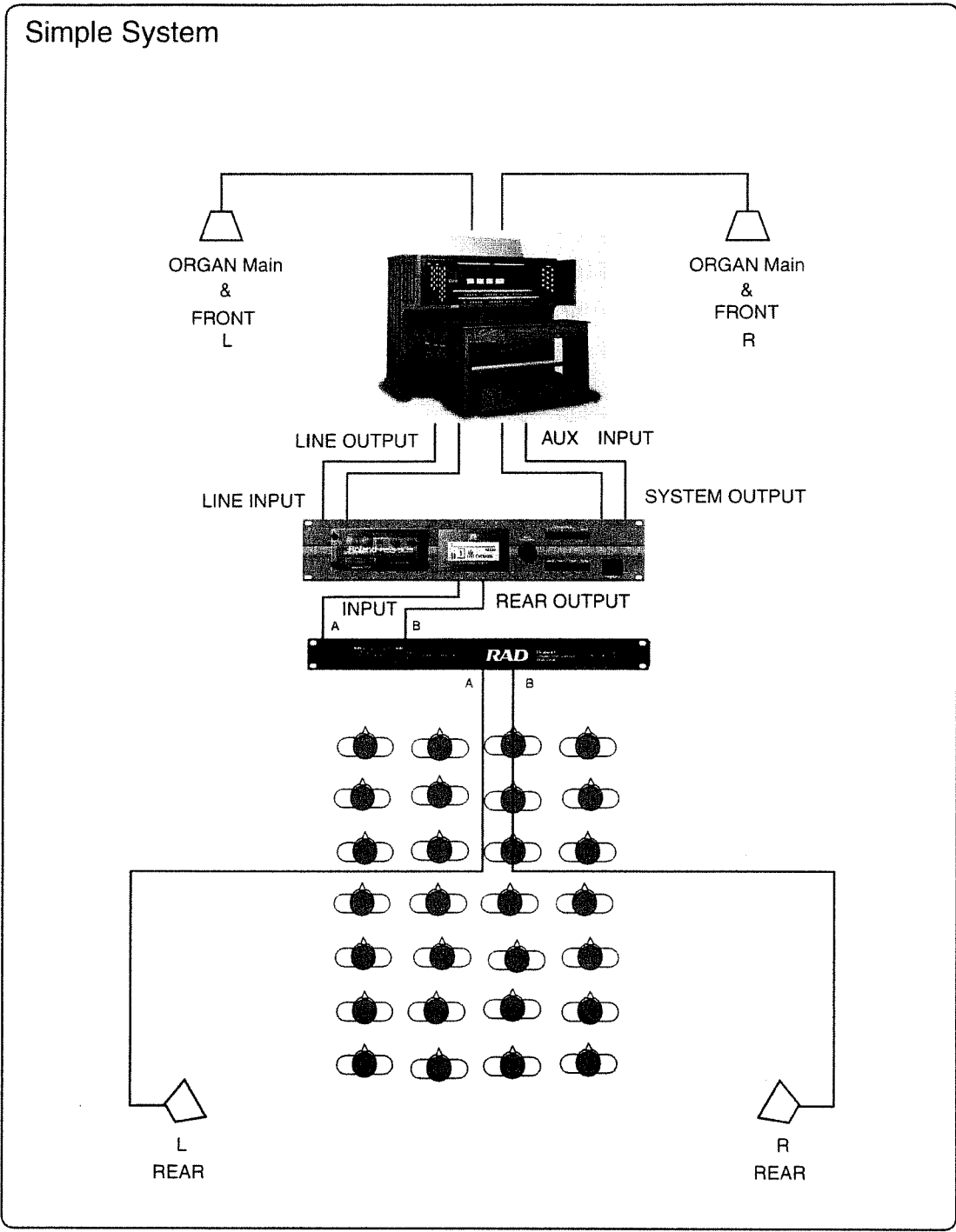

## ■ Speaker Placement and Connections for an Extended System

This explains a system that uses two RSS-303 units.  
The RSS-303 will use dedicated speakers for both front and rear.

### ● Speaker placement

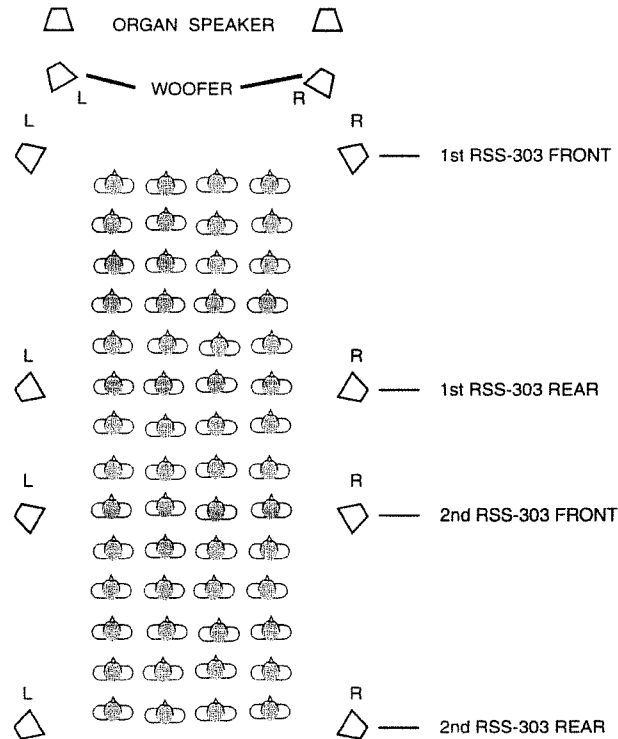

- ❑ 1 You will need eight channels of amplifiers, and eight speakers.  
If the system is intended for an audience of several hundred people, you should use amps and speakers of 100 watts or greater.  
Use speakers whose directional characteristics are as wide as possible.
- ❑ 2 Place the speakers.  
Place the speakers so they surround the audience as shown in the diagram.  
As a rule, each speaker should be pointed to face the audience.

### ● Connections between the RSS-303, amps, and organ

From the first RSS-303's [FRONT OUTPUT] and [REAR OUTPUT] to the amps  
From the second RSS-303's [FRONT OUTPUT] and [REAR OUTPUT] to the amps  
From the second RSS-303's [SYSTEM OUTPUT] to the first RSS-303's [LINE INPUT]  
The organ output to the second RSS-303's [AUX INPUT]

- ❑ 3 Make connections.

### ● Set the MIX switches

- ❑ 4 Turn on the [MIX-AUX INPUT] switch of the second RSS-303.
- ❑ 5 Turn off the [MIX-FRONT OUTPUT] switch of the second RSS-303.

### ● Connect MIDI

- ❑ 6 Connect the first RSS-303's [MIDI OUT] to the second RSS-303's [MIDI IN].



Although MIDI messages flow from the first unit to the second unit, the audio signals flow in the opposite direction; from the second unit to the first unit. Be careful not to make a mistake in the connections.

### ● Level settings

- ❑ 7 Turn off the [LOW-FREQ. OUTPUT LEVEL] switch of the second RSS-303.

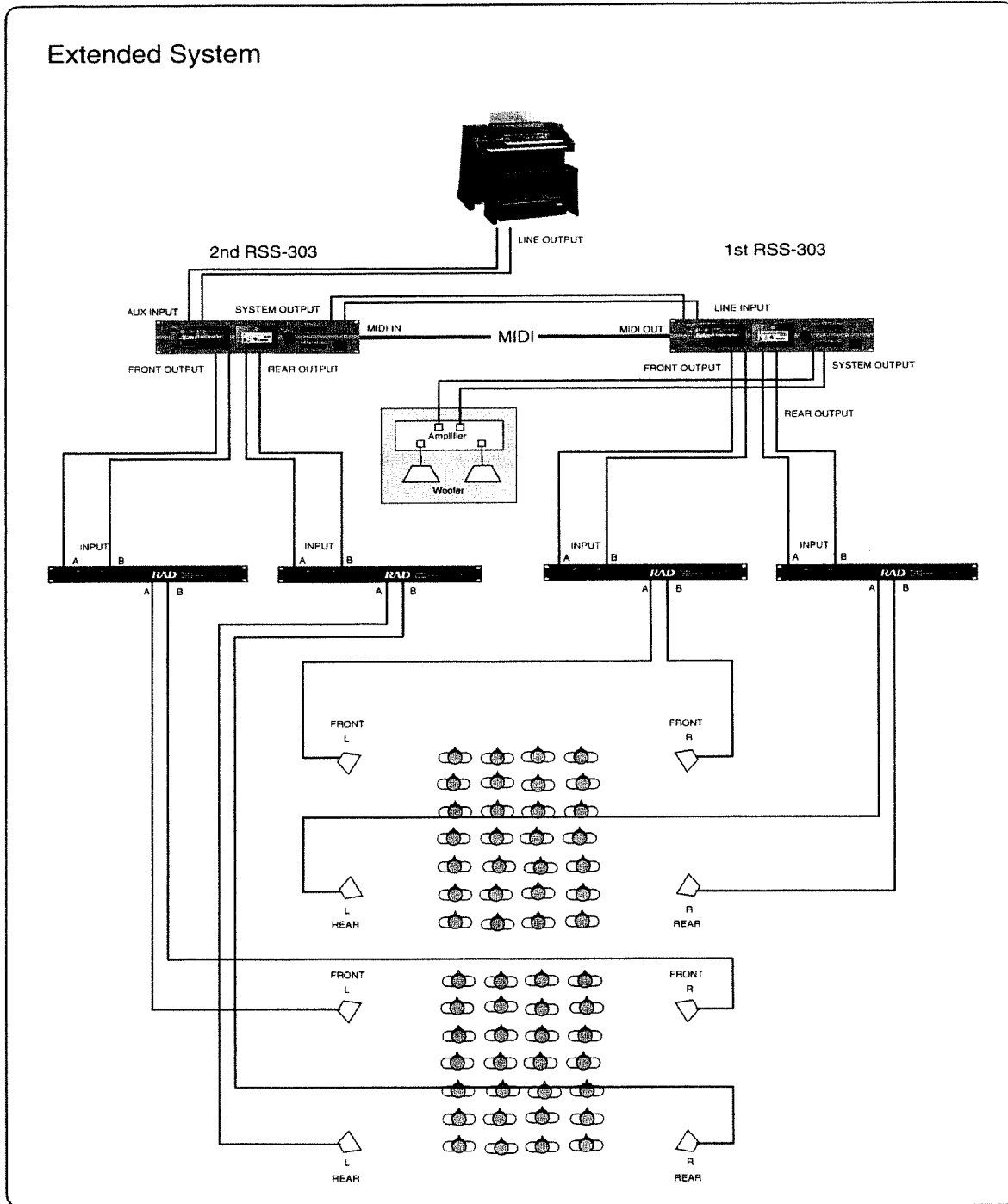

# Placement, Setting, and Adjustment Procedure

## ■ Preparations for Settings

### ● Certain settings are required to obtain the ideal reverberation.

- First read page 23, “■About Field Settings.”

### ● Decide on the size of your system.

We use the term “field” to refer to the area to which you wish to add reverberation using an RSS-303.

In other words, a field is an area enclosed by the four speakers of a single RSS-303.

For locations the size of a medium hall, a single field created by one RSS-303 will cover virtually all of the audience seats.

For a location larger than this, it may be good to divide the area into two fields.

The number of fields for the area will depend on the location.

Provide a number of RSS-303 units to match the number of divided fields.

- If the second-floor seating is broad and extends over the first-floor seating, it is probably best to divide into one field for the first floor and another for the second floor.
- As another example, if the location is very long and narrow it is probably best to divide it into two fields, front and back.
- In the case of an extremely large area, it would be conceivable to divide it into fields as shown in the diagram below.

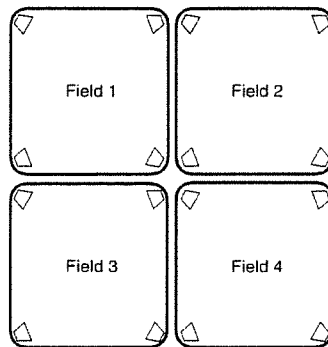

### ● Decide on system configuration, place the equipment, and make connections.

Decide on the appropriate system configuration for the size of the space.

- To cover an audience of several hundred people or fewer with one field  
Refer to “■Speaker Placement and Connections for a Basic System.” ☞ page 49
- To construct the smallest possible system  
Refer to “■Speaker Placement and Connections for a Simple System.” ☞ page 51
- To use two fields to cover a broad space  
Refer to “■Speaker Placement and Connections for an Extended System.” ☞ page 53
- Creating a system using a Rodgers organ  
 For details on the system, refer to  
“■Contact Points for Rodgers Organs.” ☞ page 59

### ● Decide on the speaker elevation and direction.

- The speakers should be placed at a level that is above the ears of the audience.
- In general, speakers should be pointed at the audience.
- If the field has little reverberation of its own  
The reverberation from the speakers may be too noticeable.  
If this occurs, you can point the speakers away from the audience and toward the wall, so the sound is not too obvious.

● **Turn on the power and check the connections.**

- For a system with a Rodgers organ
  - ❑ Turn on the power as described in page 9, “Turning on Power.”
- When using the RSS-303 by itself
  - ❑ Turn on the power as described in page 9, “Turning on Power.”

● **Next, check the connections.**

The RSS-303 provides a program to check connections.  
The switch to enter this mode is located under the protective cover.

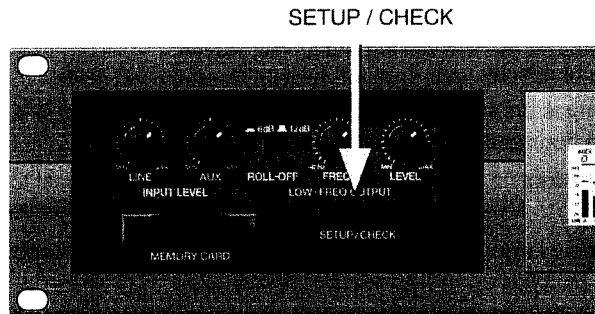

- ❑ Remove the protective cover at the left side of the RSS-303's front panel.
- ❑ Press the [SETUP/CHECK] button.

● **The RSS-303 enters Setup mode.**

```
RSS-303 Ver. 1.00
Setup Mode - HELP: [S3]
Exit: [EXIT]      MENU: [S4]
```

- ❑ Select MENU. Press [S4].

● **The RSS-303 enters connection check mode.**

```
Check Connection: [S1]
Field Setup: [S2]
Other Setup: [S3] / Audio: [S4]
```

- ❑ Select Check Connection. Press [S1].

● **A connection check is performed.**

- ❑ At this point, perform the procedure given on page 28, “Checking Connections.”

● **This completes the connections and checking. Now you can begin making settings.**



---

## ■ Starting Setup

---

● **Now we make settings.**

- Perform the procedure given on pages 31-33, "■ Making Field Settings."

● **This completes essential settings.**

● **Return to normal operating mode and begin the sound check.**

- Use the procedure on page 25 "■ Finishing Setup" to return to normal operating mode.

● **Select the room type.**

- Refer to page 16 "■ Changing Room Type," and perform the procedure.

● **Select the wall type.**

- Refer to page 18 "■ Changing Wall Type," and perform the procedure.

● **Play the organ to hear the result.**

● **Now check the character of the reverberation.**

- Do you hear any of the following?
  - The high-frequency portion of the reverberation is obtrusive.
  - The low-frequency portion resonates with the building and is abnormally loud.
  - There is some other irregularity with the tone of the reverberation.
- Refer to page 58 "■ Adjusting Reverberation Tone," and make appropriate adjustments.

● **Adjust the low-frequency portion of the reverberation.**

If you are not able to use particularly large front and rear speakers, the low-frequency portion of the reverberation will not be reproduced adequately. In such cases, the RSS-303 makes it possible to output only the low-frequency portion of the reverberation from [SYSTEM OUTPUT]. By reproducing this through an amp and speaker dedicated to low-frequencies, you can adjust the overall balance of the reverberation.

In a cathedral made of stone or brick, there will be good reverberation extending even to the fairly low frequency range. This low-frequency range is a very important element in the reverberation of a pipe organ.

For details on this adjustment, refer to page 46 "■ Low Frequency Output Adjustment."

● **Similarly, if you are not able to use a particularly large front or rear speaker, you can insert a 100 Hz high-pass filter into the front/rear outputs, so excessive low-frequency components will not generate distortion.**

For details on this adjustment, refer to page 42 "■ Output High-pass Filter."



For details, refer to  
 "■ Starting Setup."  
 "■ Setup Menu."  
 "■ Making Other Settings."

📖 page 24  
 📖 page 27  
 📖 page 34

---

## ■ Adjusting Reverberation Tone

---

- If the reverberation has undesirable characteristics, you can remove them.

- Enter setup mode once again.

- Remove the protective cover, and press the [SETUP/CHECK] button.

- The RSS-303 enters setup mode.

RSS-303 Ver. 1.00	
Setup Mode - HELP: [S3]	
Exit: [EXIT]	MENU: [S4]

- Select MENU. Press [S4].

Check Connection: [S1]	
Field Setup: [S2]	
Other Setup: [S3] / Audio: [S4]	

- Enter the mode for making other settings.

- Select Audio. Press [S3].

Other setup / Audio			
EQ	Hi-Pass	Output	
[S1]	[S2]	[S3]	[S4]

- Select EQ. Press [S1].

- Use the parametric equalizer to make adjustments.

EQ	Band 1: [S1][S2][S3]		
◆ 3.3 kHz	12/12 Oct	+12.0 dB	
Freq: [F1]	Width: [F2]	Gain: [F4]	

- Make adjustments according to the procedure given on page 41 "■ Compensating for Speaker Response and Playback Location Acoustic Irregularities."

## ■ Contact Points for Rodgers Organs

---

Rodgers Instruments LLC  
1300 N.E. 25th Avenue  
Hillsboro, Oregon 97124  
U. S. A.

Tel: 503-648-4181  
FAX: 503-681-0444

\* *Or, please contact the nearest Roland Service Center or authorized Roland distributor.*

# Specification

## RSS-303 RSS Ambience System

### ● Nominal Input Level

XLR: -25 to +4 dBm (Balance)  
D-SUB: -20 dBm (Unbalance)

### ● Input Impedance

XLR: 16k ohm (HOT-GND, COLD-GND),  
32k ohm (HOT-COLD)  
D-SUB: 10k ohm

### ● Nominal Output Level

XLR: +4 dBm (Balance)  
D-SUB: -20 dBm (Un balance)

### ● Maximum Output Level

XLR: +22 dBm (Balance)  
D-SUB: -2 dBm (Un balance)

### ● Output Impedance

XLR: 320 ohm (HOT-GND, COLD-GND),  
640 ohm (HOT-COLD)  
D-SUB: 1.0k ohm

### ● Controls

FRONT PANEL:

LINE INPUT LEVEL  
AUX INPUT LEVEL  
LOW-FREQUENCY  
LOW-FREQUENCY OUTPUT LEVEL  
LOW-FREQUENCY ROLL OFF SW  
SETUP/CHECK SW  
  
USER PROGRAM BUTTON  
MUTE BUTTON  
ROOM TYPE BUTTON  
WALL TYPE BUTTON  
TIME BUTTON  
LEVEL BUTTON  
VALUE NOB  
EXIBIT BUTTON

REAR PANEL:

POWER CONTROL SW  
  
AUX INPUT MIX SW  
FRONT OUTPUT MIX SW

### ● Display

Graphic LCD (backlit LCD)

### ● Connectors

XLR type:

LINE INPUT  
AUX INPUT  
FRONT OUTPUT  
REAR OUTPUT  
SYSTEM OUTPUT

DB-9 type:

ORGAN INPUT  
CHAIN OUTPUT  
FRONT OUTPUT  
REAR OUTPUT

Screw terminal:

REMOTE CONTROLLER  
NON-VOLTAGE MAKE/BREAK CONTACTS

MIDI:

IN  
OUT/THRU

### ● Power Supply

AC 117 V (50/60 Hz), AC 230 V (50/60 Hz), 240 V (50/60 Hz)

### ● Power Consumption

14 W (AC 117 V), 15W (AC 230 V), 16 W (AC 240 V)

### ● Dimentions

482 mm (W) x 300 mm (D) x 88 mm (H)  
(EIA-2U rack mount type)

### ● Weight

4.3 kg/ 9 lbs 8 oz  
350 g/ 13 oz (Remote Controller)

### ● Accessories

Owner's Manual English  
AC Cord  
Remote Controller

\*  $0 \text{ dBm} = 0.775 \text{ Vrms}$

\* *In the interest of product improvement, the specifications and/or appearance of this unit are subject to change without prior notice.*

Date : Feb. 4, 2000

Model RSS-303

**MIDI Implementation Chart**

Version : 1.00

Function...	Transmitted	Recognized	Remarks
Basic Channel Default Changed	X	1-16	
Mode Default Messages Altered	X X *****	X X X	
Note Number : True Voice	X *****	X *****	
Velocity Note On Note Off	X X	X X	
After Touch Key's Channel's	X X	X X	
Pitch Bend	X	X	
Control Change	0 X 32 X 1-31 X 33-63 X 64-95 X	X X X X X	
Program Change : True Number	X *****	X	
System Exclusive	O	O	
System Common : Song Position : Song Select : Tune Request	X X X	X X X	
System Real Time : Clock : Commands	X X	X X	
Aux Messages : All Sound Off : Reset All Controllers : Local On/Off : All Notes Off : Active Sensing : System Reset	X X X X X X	X X X X X X	
Notes			

Mode 1 : OMNI ON, POLY  
Mode 3 : OMNI OFF, POLYMode 2 : OMNI ON, MONO  
Mode 4 : OMNI OFF, MONOO : Yes  
X : No

A separate publication titled "MIDI Implementation" is also available. It provides complete details concerning the way MIDI has been implemented on this unit. If you should require this publication (such as when you intend to carry out byte-level programming), please contact the nearest Roland Service Center or authorized Roland distributor.

# Index

## A

Ambience .....	20
Ambience Sound .....	11, 15, 22, 45
AUX INPUT .....	43, 45

## B

Band .....	41
Basic System .....	49

## C

Connection Check Mode .....	26
Contrast .....	37
Cutoff Frequency .....	46

## D

Device ID .....	37
D-SUB Connectors .....	47

## E

Essential Settings .....	23
Extended System .....	53

## F

Field .....	55
FRONT OUT .....	44
FRONT OUTPUT .....	45
Front Panel .....	7

## G

Gain .....	41
------------	----

## H

High-pass Filter .....	42, 57
------------------------	--------

## I

Input Level .....	43
-------------------	----

## L

LCD .....	37
LINE INPUT .....	43
Load .....	39
Low Frequency Output .....	46
Low Frequency Portion .....	45, 57
Low-pass Filter .....	46

## M

Mute .....	11, 15
------------	--------

## N

No-voltage Make/Break Contacts .....	47
--------------------------------------	----

## O

Operation Mode .....	10, 13
----------------------	--------

Other Settings .....	34
Output .....	42
Output Channel .....	28
Output Level .....	42

## P

Parameters .....	39–40
Parametric Equalizer .....	41, 58
Power Distributor .....	47

## R

REAR OUT .....	44
Rear Panel .....	7
Remote Controller .....	7, 48
Reverb Time .....	20
Reverberation .....	58
Rodgers Organ .....	9
Roll-off Curve .....	46
Room Type .....	16–17

## S

Save .....	40
Settings .....	23
Setup Mode .....	24, 58
Simple System .....	51
Speaker Placement .....	49, 51, 53
Speaker Response .....	41
SYSTEM OUT .....	44
SYSTEM OUTPUT .....	45

## U

User Mode .....	36
User Program .....	10, 14, 22

## W

Wall Type .....	18–19
-----------------	-------

## X

XLR type connectors .....	8
---------------------------	---



For EU Countries

This product complies with the requirements of European Directives EMC 89/336/EEC and LVD 73/23/EEC.

For the USA

### FEDERAL COMMUNICATIONS COMMISSION RADIO FREQUENCY INTERFERENCE STATEMENT

This equipment has been tested and found to comply with the limits for a Class B digital device, pursuant to Part 15 of the FCC Rules. These limits are designed to provide reasonable protection against harmful interference in a residential installation. This equipment generates, uses, and can radiate radio frequency energy and, if not installed and used in accordance with the instructions, may cause harmful interference to radio communications. However, there is no guarantee that interference will not occur in a particular installation. If this equipment does cause harmful interference to radio or television reception, which can be determined by turning the equipment off and on, the user is encouraged to try to correct the interference by one or more of the following measures:

- Reorient or relocate the receiving antenna.
- Increase the separation between the equipment and receiver.
- Connect the equipment into an outlet on a circuit different from that to which the receiver is connected.
- Consult the dealer or an experienced radio/TV technician for help.

Unauthorized changes or modification to this system can void the users authority to operate this equipment. This equipment requires shielded interface cables in order to meet FCC class B Limit.

For Canada

### NOTICE

This Class B digital apparatus meets all requirements of the Canadian Interference-Causing Equipment Regulations.

### AVIS

Cet appareil numérique de la classe B respecte toutes les exigences du Règlement sur le matériel brouilleur du Canada.

## Information

When you need repair service, call your nearest Roland Service Center or authorized Roland distributor in your country as shown below.

### AFRICA

#### EGYPT

**Al Fanny Trading Office**  
P.O. Box 2904,  
El Horrieh Heliopolis, Cairo,  
EGYPT  
TEL: (02) 4185531

#### REUNION

**Maison FO - YAM Marcel**  
25 Rue Jules Merman, ZL  
Chaudron - BP79 97491  
Ste Clotilde REUNION  
TEL: 28 29 16

#### SOUTH AFRICA

**That Other Music Shop  
(PTY) Ltd.**

11 Melle Street (Cnr Melle and  
Juta Street)  
Braamfontein, 2001,  
Republic of SOUTH AFRICA  
TEL: (011) 403 4105

**Paul Bothner (PTY) Ltd.**

17 Werdmuller Centre Clarendon  
7700  
Republic of SOUTH AFRICA

P.O. Box 23032  
Claremont, Cape Town  
SOUTH AFRICA, 7735  
TEL: (021) 64 4030

### ASIA

#### CHINA

**Beijing Xinghai Musical  
Instruments Co., Ltd.**  
6 Huangmunchang Chao Yang  
District, Beijing, CHINA  
TEL: (010) 6774 7491

#### HONG KONG

**Tom Lee Music Co., Ltd.  
Service Division**  
22-32 Pun Shan Street, Tsuen  
Wan, New Territories,  
HONG KONG  
TEL: 2415 0911

#### INDIA

**Rivera Digitec (India) Pvt. Ltd.**  
409, Nirman Kendra Mahalaxmi  
Flats Compound Off. Dr. Edwin  
Moses Road, Mumbai-400011,  
INDIA  
TEL: (022) 498 3079

#### INDONESIA

**PT Citra IntiRama**  
Jl. Cideng Timur No. 15J-150  
Jakarta Pusat  
INDONESIA  
TEL: (021) 6324170

#### KOREA

**Cosmos Corporation**  
1461-9, Seocho-Dong,  
Seocho Ku, Seoul, KOREA  
TEL: (02) 3486-8855

#### MALAYSIA

**Bentley Music SDN BHD**  
140 & 142, Jalan Bukit Bintang  
55100 Kuala Lumpur, MALAYSIA  
TEL: (03) 2443333

#### PHILIPPINES

**G.A. Yupangco & Co. Inc.**  
339 Gil J. Puyat Avenue  
Makati, Metro Manila 1200,  
PHILIPPINES  
TEL: (02) 899 9801

#### SINGAPORE

**Swee Lee Company**  
150 Sims Drive,  
SINGAPORE 387381  
TEL: 748-1669

#### CRISTOFORI MUSIC PTE LTD

Bik 3014, Bedok Industrial Park E,  
#02-2148, SINGAPORE 489980  
TEL: 243 9555

#### TAIWAN

**ROLAND TAIWAN  
ENTERPRISE CO., LTD.**  
Room 5, 9th. No. 112 Chung Shan  
N.Road Sec.2, Taipei, TAIWAN,  
R.O.C.  
TEL: (02) 2561 3339

#### THAILAND

**Theera Music Co., Ltd.**  
330 Verng NakornKasem, Soi 2,  
Bangkok 10100, THAILAND  
TEL: (02) 2248821

#### VIETNAM

**Saigon Music**  
138 Tran Quang Khai St.,  
District 1  
Ho Chi Minh City  
VIETNAM  
TEL: (08) 844-4068

### AUSTRALIA/ NEW ZEALAND

#### AUSTRALIA

**Roland Corporation  
Australia Pty., Ltd.**  
38 Campbell Avenue  
Dee Why West, NSW 2099  
AUSTRALIA  
TEL: (02) 9982 8266

#### NEW ZEALAND

**Roland Corporation (NZ) Ltd.**  
97 Mt. Eden Road, Mt. Eden,  
Auckland 3, NEW ZEALAND  
TEL: (09) 3098 715

### CENTRAL/LATIN AMERICA

#### ARGENTINA

**Instrumentos Musicales S.A.**  
Florida 656 2nd Floor  
Office Number 206A  
Buenos Aires  
ARGENTINA, CP1005  
TEL: (54-11) 4- 393-6057

#### BRAZIL

**Roland Brasil Ltda.**  
R. Coronel Octaviano da Silveira  
203 05522-010  
Sao Paulo BRAZIL  
TEL: (011) 3743 9377

#### COSTA RICA

**JUAN Bansbach  
Instrumentos Musicales**  
Ave.1, Calle 11, Apartado 10237,  
San Jose, COSTA RICA  
TEL: (506)258-0211

#### CHILE

**Comercial Fancy S.A.**  
Avenida Rancagua #0330  
Providencia Santiago, CHILE  
TEL: 56-2-373-9100

#### EL SALVADOR

**OMNI MUSIC**  
75 Avenida Notre YY Alameda,  
Juan Pablo 2, No. 4010  
San Salvador, EL SALVADOR  
TEL: (503) 262-0788

#### MEXICO

**Casa Veerkamp, s.a. de c.v.**  
Av. Toluca No. 323, Col. Olivar  
de los Padres 01780 Mexico D.F.  
MEXICO  
TEL: (525) 668 04 80

**La Casa Wagner de  
Guadalajara s.a. de c.v.**  
Av. Corona No. 202 S.J.  
Guadalajara, Jalisco Mexico  
C.P.44100 MEXICO  
TEL: (3) 613 1414

#### PANAMA

**SUPRO MUNDIAL, S.A.**  
Boulevard Andrews, Albrook,  
Panama City,  
REP. DE PANAMA  
TEL: (507) 315-0101

#### PARAGUAY

**Distribuidora De  
Instrumentos Musicales**  
J.E. Olear y ESQ. Manduvira  
Edeficio, El Dorado Planta Baja  
Asuncion PARAGUAY  
TEL: 595-21-492147

#### PERU

**VIDEO Broadcast S.A.**  
Portinari 199 (ESQ. HALS),  
San Borja, Lima 41,  
REP. OF PERU  
TEL: 51-14-758226

#### URUGUAY

**Todo Musica S.A.**  
Cuareim 1844, Montevideo,  
URUGUAY  
TEL: 5982-924-2335

#### VENEZUELA

**Musiland Digital C.A.**  
Av. Francisco de Miranda,  
Centro Parque de Cristal, Nivel  
C2 Local 20 Caracas  
VENEZUELA  
TEL: (02) 285 9218

### EUROPE

#### AUSTRIA

**Roland Austria GES.M.B.H.**  
Siemensstrasse 4, P.O. Box 74,  
A-6063 RUM, AUSTRIA  
TEL: (0512) 26 44 260

#### BELGIUM/HOLLAND/ LUXEMBOURG

**Roland Benelux N. V.**  
Houtstraat 3, B-2260, Oevel  
(Westerlo) BELGIUM  
TEL: (014) 575811

#### DENMARK

**Roland Scandinavia A/S**  
Nordhavnsvej 7, Postbox 880,  
DK-2100 Copenhagen  
DENMARK  
TEL: (039)16 6200

#### FRANCE

**Roland France SA**  
4, Rue Paul Henri SPAAK,  
Parc de l'Esplanade, F 77 462 St.  
Thibault, Lagny Cedex FRANCE  
TEL: 01 600 73 500

#### FINLAND

**Roland Scandinavia As,  
Filial Finland**  
Lautasaarentie 54 B  
Fin-00201 Helsinki, FINLAND  
TEL: (9) 682 4020

#### GERMANY

**Roland Elektronische  
Musikinstrumente HmbH.**  
Oststrasse 96, 22844 Norderstedt,  
GERMANY  
TEL: (040) 52 60090

#### GREECE

**STOLLAS S.A.**  
Music Sound Light  
155, New National Road  
26422 Patras, GREECE  
TEL: 061-435400

#### HUNGARY

**Intermusica Ltd.**  
Warehouse Area 'DEPO' Pl.83  
H-2046 Torokbalint, HUNGARY  
TEL: (23) 511011

#### IRELAND

**Roland Ireland**  
Audio House, Belmont Court,  
Donnybrook, Dublin 4,  
Republic of IRELAND  
TEL: (01) 2603501

#### ITALY

**Roland Italy S. p. A.**  
Viale delle Industrie 8,  
20020 Arese, Milano, ITALY  
TEL: (02) 937-78300

#### NORWAY

**Roland Scandinavia Avd.  
Kontor Norge**  
Lilleakerveten 2 Postboks 95  
Lilleaker N-0216 Oslo  
NORWAY  
TEL: 273 0074

#### POLAND

**P. P. H. Brzostowicz**  
UL. Gibraltarska 4,  
PL-03664 Warszawa POLAND  
TEL: (022) 679 44 19

#### PORTUGAL

**Tecnologias Musica e Audio,  
Roland Portugal, S.A.**  
RUA DE SANTA CARARINA  
131/133, 4000-450 PORTO  
PORTUGAL  
TEL: (022) 208 4456

#### ROMANIA

**FBS LINES**  
Plata Libertatii 1,  
RO-4200 Cheorgheni  
TEL: (066) 164-609

#### RUSSIA

**Slami Music Company**  
Sadovaya-Triumfalnaya st., 16  
103006 Moscow, RUSSIA  
TEL: 095 209 2193

#### SPAIN

**Roland Electronics  
de España, S. A.**  
Calle Bolivia 239, 08020  
Barcelona, SPAIN  
TEL: (93) 308 1000

#### SWEDEN

**Roland Scandinavia A/S  
SWEDISH SALES OFFICE**  
Danvik Center 28, 2 tr.  
S-131 30 Nacka SWEDEN  
TEL: (08) 702 0020

#### SWITZERLAND

**Roland (Switzerland) AG  
Musitronic AG**  
Gerberstrasse 5, CH-4410 Liestal,  
SWITZERLAND  
TEL: (061) 921 1615

#### UKRAINE

**TIC-TAC**  
Mira Str. 19/108  
P.O. Box 180  
295400 Munkachevo, UKRAINE  
TEL: (03131) 414-40

#### UNITED KINGDOM

**Roland (U.K.) Ltd.**  
Atlantic Close, Swansea  
Enterprise Park, SWANSEA  
SA7 9PJ,  
UNITED KINGDOM  
TEL: (01792) 700139

### MIDDLE EAST

#### BAHRAIN

**Moon Stores**  
Bab Al Bahrain Road,  
P.O. Box 20077  
State of BAHRAIN  
TEL: 211 005

#### CYPRUS

**Radex Sound Equipment Ltd.**  
17 Diagorou St., P.O. Box 2046,  
Nicosia CYPRUS  
TEL: (02) 453 426

#### ISRAEL

**Halilit P. Greenspoon &  
Sons Ltd.**  
8 Retzif Fa'aliya Hashnya St.  
Tel-Aviv-Yaho ISRAEL  
TEL: (03) 6823666

#### JORDAN

**AMMAN Trading Agency**  
Prince Mohammed St. P.O. Box  
825 Amman 11118 JORDAN  
TEL: (06) 4641200

#### KUWAIT

**Easa Husain Al-Yousifi**  
Abdullah Salem Street,  
Safat KUWAIT  
TEL: 5719499

#### LEBANON

**A. Chahine & Fils**  
P.O. Box 16-5857 Gergi Zeidan St.  
Chahine Building, Achrafieh  
Beirut, LEBANON  
TEL: (01) 335799

#### QATAR

**Badie Studio & Stores**  
P.O. Box 62,  
DOHA QATAR  
TEL: 423554

#### SAUDI ARABIA

**aDawlah Universal  
Electronics APL**  
P.O. Box 2154 ALKHOBAR 31952,  
SAUDI ARABIA  
TEL: (03) 898 2081

#### SYRIA

**Technical Light & Sound  
Center**  
Khaled Ibn Al Walid St.  
P.O. Box 13520  
Damascus - SYRIA  
TEL: (011) 2235 384

#### TURKEY

**Barkat muzik aletleri ithalat  
ve ihracat Ltd Sti**  
Siraselviler cad.Guney is hani 84-  
86/6, Taksim, Istanbul, TURKEY  
TEL: (0212) 2499324

#### U.A.E.

**Zak Electronics & Musical  
Instruments Co. L.L.C.**  
Zabeel Road, Al Sherooq Bldg.,  
No. 14, Grand Floor DUBAI  
U.A.E.  
TEL: (04) 3360715

### NORTH AMERICA

#### CANADA

**Roland Canada Music Ltd.  
(Head Office)**  
5480 Parkwood Way Richmond  
B. C., V6V 2M4 CANADA  
TEL: (0604) 270 6626

#### Roland Canada Music Ltd. (Toronto Office)

Unit 2, 109 Woodbine Downs  
Blvd, Etobicoke, ON  
M9W 6Y1 CANADA  
TEL: (0416) 213 9707

#### U. S. A.

**Roland Corporation U.S.**  
5100 S. Eastern Avenue  
Los Angeles, CA 90040-2938,  
U. S. A.  
TEL: (323) 890 3700

As of June 1, 2000 (Roland)





 Roland®

---

**71672290**

UPC

71672290



10991

**Roland**