

BOSS

RV-2

Digital Reverb

INSTRUCTIONS

Please read the instructions carefully.

- The BOSS RV-2 is a compact, versatile and high sound quality digital reverb effect that is incorporated with a high quality DSP (Digital Signal Processor) chip.
- The RV-2 features six effect modes, allowing you to create wide variety of reverb effects, from natural reverberations to gated reverb and delay.
- Reverb and gate times can be changed continuously by using the rotary knob.
- Provided with a pre-equalizer, the RV-2 can spontaneously control the tone of the reverb sounds.

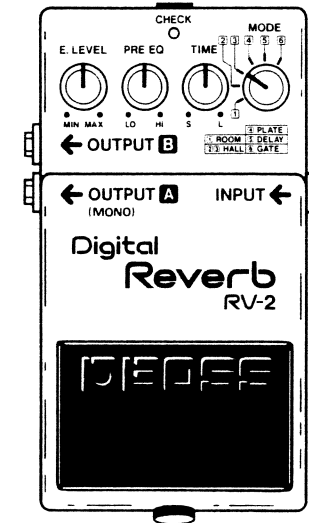

PANEL DESCRIPTION

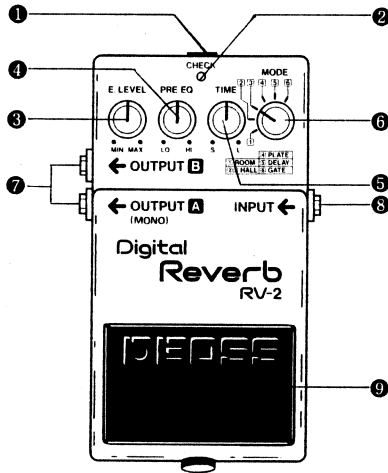

1 AC Adaptor Jack

Connect the supplied AC adaptor (BOSS PAS series) to this jack. Connecting an AC adaptor will turn on the unit.

2 Check Indicator

This lights up when the effect is turned on.

3 Effect Level Knob

This knob changes the volume of the effect (reverb or delay) sound. Rotating it clockwise increases the volume. At the MAX position, the volume of the effect sound is equal to the direct sound. At the fully counterclockwise position, only the direct sound is heard.

4 Pre-equalizer Knob

This adjusts the tone of the effect (reverb or delay) sound. Rotating it clockwise emphasizes higher frequencies, creating brighter sound, and rotating it counterclockwise cuts higher frequencies, making warmer sound.

Mode 1	ROOM	Reverb effect in a room up to 8 square meter.
Mode 2	HALL 1	Reverb effect in a small up to 15 square meter.
Mode 3	HALL 2	Reverb effect in a large hall up to 30 square meter.
Mode 4	PLATE	Plate reverb normally used for studio recording. Bright reverb with a little amount of decay in higher frequencies.
Mode 5	Delay	In monaural use, a normal delay effect is obtained, but in stereo, panning delay (delay sounds alternately come out from the right and left) is obtained.
Mode 6	GATE	Gate reverb that is ideal for percussive sounds.

5 Time Knob

This sets reverb time (or gate or delay time). Clockwise rotation increases the time.

6 Mode Selector Knob

This selects one of the six effect modes. See the left table.

7 Output Jacks A and B

Connect these jacks to amplifiers. Stereo outputs are obtained.

* For monaural connection, use only the Output Jack-A.

8 Input Jack

This is to connect an electric musical instrument or a microphone.

* When using a microphone, be sure to turn up the level with a preamplifier or mixer (e.g. RPQ-10, BX-400, etc.).

9 Pedal Switch

Push this pedal to turn the effect on (LED on), and push it again to turn the effect off (LED off).

BEFORE USING THE UNIT

- The RV-2 does not work on battery.
- The RV-2's rated input is -20dBm . If the level of the input signal is low, noise may become too prominent, so feed high level signal to the RV-2. If that causes distortion, try setting the Pre-equalizer Knob to the left (Lo) position.
- When the unit is not to be used for a long period of time, disconnect the AC adaptor from the wall outlet.

CONNECTION

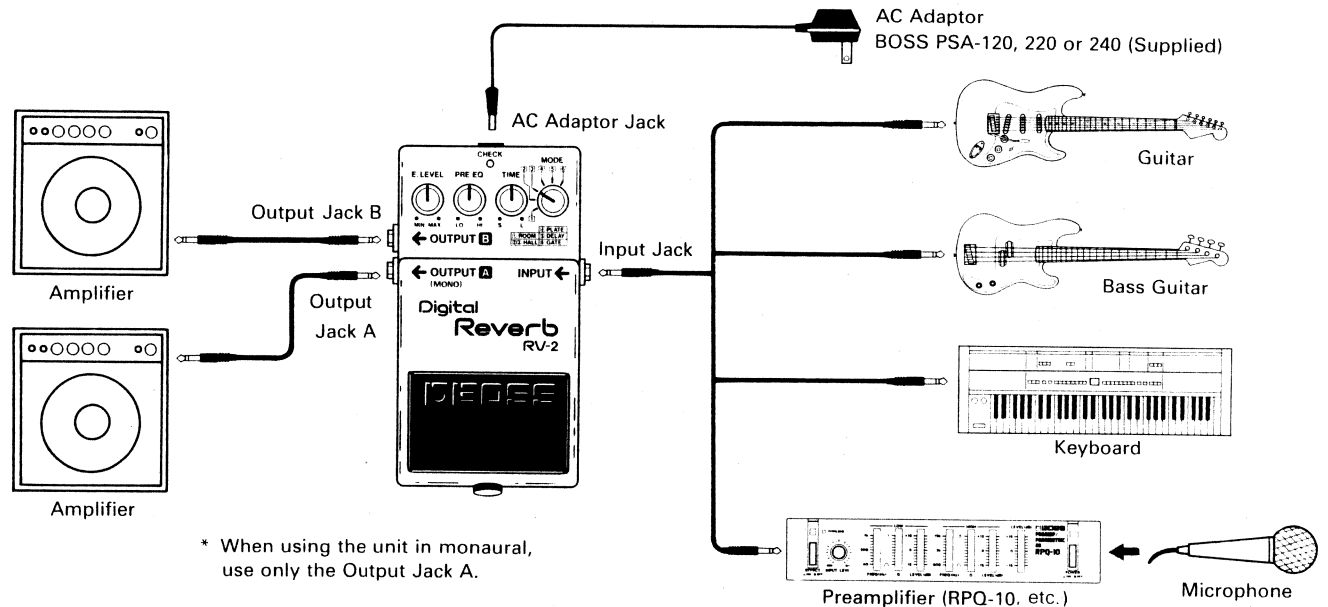

OPERATIONS

- ① After making all the connections, set the panel as shown below.

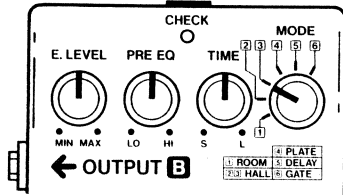

- ② Push the pedal switch. If the indicator lights up, the effect is on, and if not, the effect is off.

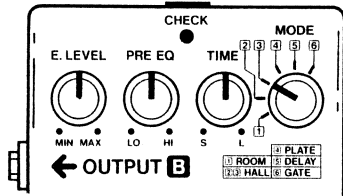

- ③ Using the Mode Selector Knob, select the effect you like.

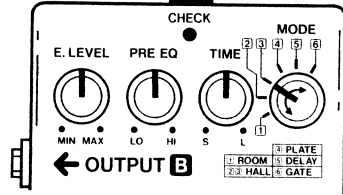

- * The moment you change the modes, muting circuits work for a few seconds, therefore, no effect sound is heard.

- ④ Set the desired reverb time (or gate time or delay time) by using the Time Knob.

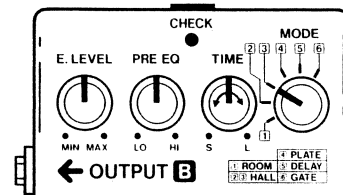

- * You may hear noise when rotating this knob, but there is nothing to worry about.

- ⑤ Adjust the tone of the effect sound with the Pre-equalizer Knob.

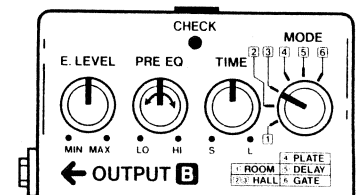

- * The Pre-equalizer Knob does not work on the direct (normal) sounds.

- ⑥ Set the volume of the effect sound with the Effect Level Knob.

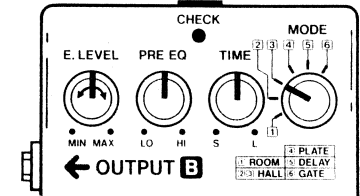

IMPORTANT NOTES

- Be sure to use the supplied BOSS AC Adaptor PSA series.
- When the unit is not to be used for a long period of time, disconnect the AC adaptor from the wall outlet.
- When making connections, be sure all the units are turned off.

SETTING EXAMPLES

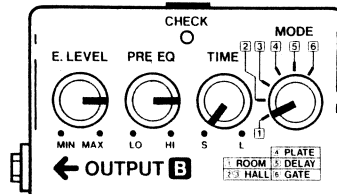

(Room)

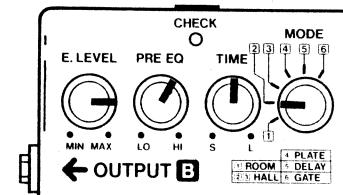

(Small Hall)

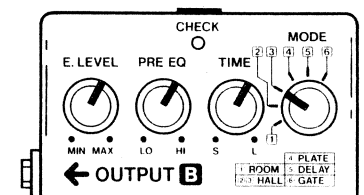

(Large Hall)

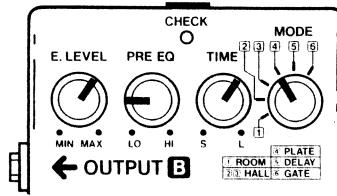

(Plate)

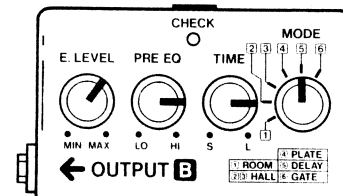

(Panning Delay)

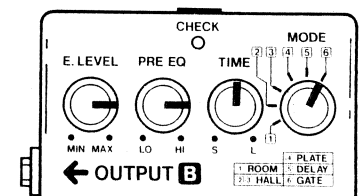

(Gated Reverb)

■ SPECIFICATION

Input Level/Input Impedance	: Rated -20dBm (1kHz)/1M Ω
Output Level/Output Impedance	: Rated -20dBm (1kHz)/4.7k Ω
Output Load Impedance	: Over 30k Ω
Frequency Response	: Effect: 30Hz to 10kHz (± 3 dB)
Sampling Frequency	: 31.25kHz
Sampling System	: 12 bit Linear
Residual Noise	: Less than -85dBm (IHF-A)
Controls	: Time Pre-equalizer Effect Level
Switches	: Mode Selector Effect ON/OFF
Indicator	: Effect ON/OFF
Jacks	: Input Outputs A and B AC Adaptor
Power	: AC 120, 220 or 240 (AC adaptor)
Consumption	: 130mA
Dimensions	: 70(W) \times 55(H) \times 125(D)mm / 2 $\frac{3}{4}$ " \times 2 $\frac{3}{16}$ " \times 4 $\frac{15}{16}$ "
Weight	: 420g/15oz
Accessory	: AC Adaptor (BOSS PSA-120, 220 or 240)

* Specifications are subject to change without notice.

 Roland®

10421

UPC

10421



10981

RADIO AND TELEVISION INTERFERENCE

Warning - This equipment has been verified to comply with the limits for a Class B computing device, pursuant to Subpart J, of Part 15, of FCC rules. Operation with non-certified or non-verified equipment is likely to result in interference to radio and TV reception."

The equipment described in this manual generates and uses radio-frequency energy. If it is not installed and used properly, that is, in strict accordance with our instructions, it may cause interference with radio and television reception.

This equipment has been tested and found to comply with the limits for a Class B computing device in accordance with the specifications in Subpart J, of Part 15, of FCC Rules. These rules are designed to provide reasonable protection against such a interference in a residential installation.

However, there is no guarantee that the interference will not occur in a particular installation. If this equipment does cause interference to radio or television reception, which can be determined by turning the equipment on and off, the user is encouraged to try to correct the interference by the following measure:

- Disconnect other devices and their input/output cables one at a time. If the interference stops, it is caused by either the other device or its I/O cable.

These devices usually require Roland designated shielded I/O cables. For Roland devices, you can obtain the proper shielded cable from your dealer. For non Roland devices, contact the manufacturer or dealer for assistance.

If your equipment does cause interference to radio or television reception, you can try to correct the interference by using one or more of the following measures:

- Turn the TV or radio antenna until the interferences stops.
- Move the equipment to one side or the other of the TV or radio.
- Move the equipment farther away from the TV or radio.
- Plug the equipment into an outlet that is on a different circuit than the TV or radio. (That is, make certain the equipment and the radio or television set are on circuits controlled by different circuit breakers or fuses.)
- Consider installing a rooftop television antenna with coaxial cable lead-in between the antenna and TV.

If necessary, you should consult your dealer or an experienced radio/television technician for additional suggestions. You may find helpful the following booklet prepared by the Federal Communications Commission:

"How to Identify and Resolve Radio-TV Interference Problems"

This booklet is available from the U.S. Government Printing Office, Washington, D.C., 20402, Stock No. 004-000-00345-4.

Bescheinigung des Herstellers/Importeurs

Hiermit wird bescheinigt, daß der/die/das

BOSS DIGITAL REVERB RV-2

(Gerät, Typ, Bezeichnung)

in Übereinstimmung mit den Bestimmungen der

Amtsbl. Vfg 1046 / 1984

(Amtsblattverfügung)

funk-enstört ist.

Der Deutschen Bundespost wurde das Inverkehrbringen dieses Gerätes angezeigt und die Berechtigung zur Überprüfung der Serie auf Einhaltung der Bestimmungen eingeräumt.

Roland Corporation Osaka/Japan

Name des Herstellers/Importeurs