



SP-303 Dr. Sample

Owner's Manual

Thank you, and congratulations on your choice of the BOSS SP-303 Dr. Sample.

Before using this unit, carefully read the sections entitled:

- **USING THE UNIT SAFELY** (page 2–3)
- **IMPORTANT NOTES** (page 10)

These sections provide important information concerning the proper operation of the unit.

Additionally, in order to feel assured that you have gained a good grasp of every feature provided by your new unit, Owner's manual should be read in its entirety. The manual should be saved and kept on hand as a convenient reference.



Copyright © 2001 BOSS CORPORATION

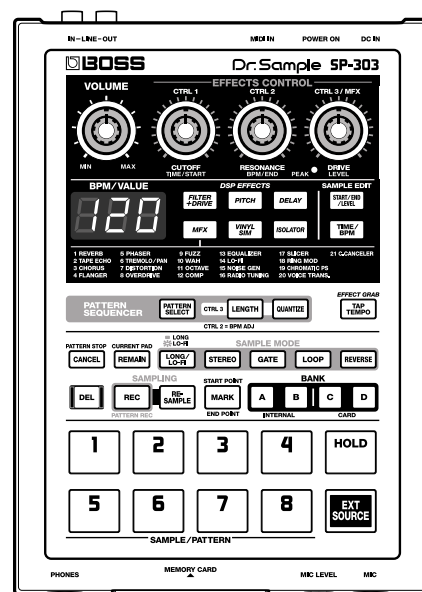

All rights reserved. No part of this publication may be reproduced in any form without the written permission of BOSS CORPORATION.









USING THE UNIT SAFELY

INSTRUCTIONS FOR THE PREVENTION OF FIRE, ELECTRIC SHOCK, OR INJURY TO PERSONS

About  WARNING and  CAUTION Notices









 WARNING	Used for instructions intended to alert the user to the risk of death or severe injury should the unit be used improperly.
 CAUTION	Used for instructions intended to alert the user to the risk of injury or material damage should the unit be used improperly. * Material damage refers to damage or other adverse effects caused with respect to the home and all its furnishings, as well to domestic animals or pets.

About the Symbols





	The  symbol alerts the user to important instructions or warnings. The specific meaning of the symbol is determined by the design contained within the triangle. In the case of the symbol at left, it is used for general cautions, warnings, or alerts to danger.
	The  symbol alerts the user to items that must never be carried out (are forbidden). The specific thing that must not be done is indicated by the design contained within the circle. In the case of the symbol at left, it means that the unit must never be disassembled.
	The  symbol alerts the user to things that must be carried out. The specific thing that must be done is indicated by the design contained within the circle. In the case of the symbol at left, it means that the power-cord plug must be unplugged from the outlet.

ALWAYS OBSERVE THE FOLLOWING

WARNING

- Before using this unit, make sure to read the instructions below, and the Owner's Manual. 
- Do not open (or modify in any way) the unit or its AC adaptor. 
- Do not attempt to repair the unit, or replace parts within it (except when this manual provides specific instructions directing you to do so). Refer all servicing to your retailer, the nearest Roland Service Center, or an authorized Roland distributor, as listed on the "Information" page. 
- Never use or store the unit in places that are:
 - Subject to temperature extremes (e.g., direct sunlight in an enclosed vehicle, near a heating duct, on top of heat-generating equipment); or are 
 - Damp (e.g., baths, washrooms, on wet floors); or are 
 - Humid; or are
 - Exposed to rain; or are
 - Dusty; or are
 - Subject to high levels of vibration.
- Make sure you always have the unit placed so it is level and sure to remain stable. Never place it on stands that could wobble, or on inclined surfaces. 
- Be sure to use only the AC adaptor supplied with the unit. Also, make sure the line voltage at the installation matches the input voltage specified on the AC adaptor's body. Other AC adaptors may use a different polarity, or be designed for a different voltage, so their use could result in damage, malfunction, or electric shock. 



WARNING

- Do not excessively twist or bend the power cord, nor place heavy objects on it. Doing so can damage the cord, producing severed elements and short circuits. Damaged cords are fire and shock hazards! 
- This unit, either alone or in combination with an amplifier and headphones or speakers, may be capable of producing sound levels that could cause permanent hearing loss. Do not operate for a long period of time at a high volume level, or at a level that is uncomfortable. If you experience any hearing loss or ringing in the ears, you should immediately stop using the unit, and consult an audiologist. 
- Do not allow any objects (e.g., flammable material, coins, pins); or liquids of any kind (water, soft drinks, etc.) to penetrate the unit. 

- Immediately turn the power off, remove the AC adaptor from the outlet, and request servicing by your retailer, the nearest Roland Service Center, or an authorized Roland distributor, as listed on the "Information" page when:
 - The AC adaptor or the power-supply cord has been damaged; or
 - Objects have fallen into, or liquid has been spilled onto the unit; or
 - The unit has been exposed to rain (or otherwise has become wet); or
 - The unit does not appear to operate normally or exhibits a marked change in performance.

⚠ WARNING

- In households with small children, an adult should provide supervision until the child is capable of following all the rules essential for the safe operation of the unit. 

- Protect the unit from strong impact. (Do not drop it!) 

- Do not force the unit's power-supply cord to share an outlet with an unreasonable number of other devices. Be especially careful when using extension cords—the total power used by all devices you have connected to the extension cord's outlet must never exceed the power rating (watts/amperes) for the extension cord. Excessive loads can cause the insulation on the cord to heat up and eventually melt through. 

- Before using the unit in a foreign country, consult with your retailer, the nearest Roland Service Center, or an authorized Roland distributor, as listed on the "Information" page. 

⚠ CAUTION

- The unit and the AC adaptor should be located so their location or position does not interfere with their proper ventilation. 

- Always grasp only the plug or the body of the AC adaptor when plugging into, or unplugging from, an outlet or this unit. 

- Whenever the unit is to remain unused for an extended period of time, disconnect the AC adaptor. 

- Try to prevent cords and cables from becoming entangled. Also, all cords and cables should be placed so they are out of the reach of children. 

- Never climb on top of, nor place heavy objects on the unit. 

- Never handle the AC adaptor body, or its plugs, with wet hands when plugging into, or unplugging from, an outlet or this unit. 

- Before moving the unit, disconnect the AC adaptor and all cords coming from external devices. 

- Before cleaning the unit, turn off the power and unplug the AC adaptor from the outlet. 

- Whenever you suspect the possibility of lightning in your area, disconnect the AC adaptor from the outlet. 

- Should you remove the screws, make sure to put them in a safe place out of children's reach, so there is no chance of them being swallowed accidentally. 

Contents

USING THE UNIT SAFELY.....	2	Chapter 3. Sampling	27
Main Features.....	6	Before Sampling.....	27
Panel Descriptions	7	Selecting Higher Quality Sampling, Extended Sampling, or Lo-Fi Sampling (Sampling Grade).....	27
IMPORTANT NOTES	10	Selecting Between Stereo and Mono Sampling	27
QUICK START	11	About Sampling Time	27
Making Connections	11	Sampling from a Microphone.....	28
Turning On the Power.....	12	Sampling from a CD or MD.....	29
Turning Off the Power	12	Sampling With the Tempo Specified Beforehand	30
Listen to the Samples	13	Starting Sampling Automatically (Auto Sampling)	31
Adding Effects to Samples.....	14	To stop auto sampling.....	32
Try Playing a Pattern	15	Making Samples with Effects Added (Resampling)	32
Playing with the Tempo Changed.....	15	Deleting an Individual Sample	33
Sampling Your Own Sounds	16	Deleting All Samples Together	34
Lifting the SP-303's Memory Protection.....	16	Changing the Assignment of Samples to the Pads.....	34
If you don't like the sampled sound	17	Checking the Remaining Sampling Time.....	35
Chapter 1. Playing Samples ...	18	Chapter 4.	
Composition of Samples	18	Changing the Sampling Settings ..	36
Switching Sample Banks.....	18	Playing Phrases Repeatedly (Loop Playback)/ Playing the Sound Only Once (One Shot Playback)....	36
Number of Samples That Can Be Played Simultaneously (Polyphony).....	18	Having Samples Play Only While the Pad Is Pressed (Gate Playback).....	36
Having a Sample Continue to Play Even When the Pad is Released (Hold)	19	Having Samples Play Even If the Pad Is Not Held Down (Trigger Playback).....	36
Playing Sounds Input From External Devices (EXT SOURCE Pad).....	19	Playing Samples in the Reverse Direction (Reverse Playback)	37
Adjusting the Volume of the External Input Sounds.....	20	Setting the Sample Volume	38
Chapter 2. Using the Effects ...	21	Preventing Unneeded Portions from Being Played (Markers/Start Point/End Point)	38
Adding Effects to Samples.....	21	Adjusting both the Start and End points	38
Turning Effects On and Off Rapidly (Effect Grab).....	22	Adjusting only the End Point	39
Selecting an Effect From MFX.....	22	Adjusting only the Start Point (End Point is the end of the sample)	39
Applying Effects to Multiple Samples	22	Finely Adjusting the Start Point and End Point	40
Applying Effects to All Samples Simultaneously.....	23	Deleting Unwanted Portions (Truncate).....	41
Effects List.....	24	Changing the Sample's BPM	41
		Changing the Length of a Sample Without Changing the Pitch (Time Modify).....	42

**Chapter 5.
Recording Sample Performances
(Pattern Sequencer) 43**

Composition of Patterns43
Changing the Tempo of a Pattern.....43
 To Synchronize with a CD's or Turntable's Tempo..... 43
Stopping Patterns44
Switching Patterns While Playback Is in Progress44
Recording the Pattern.....44
 Erasing the Data for Mistakes in Performances..... 46
Deleting Patterns.....46
 Specifying and Deleting a Single Pattern 46
 Deleting All Patterns Together..... 47
Changing the Assignment of Patterns to the Pads47

**Chapter 6.
Using Memory Cards 48**

Memory Cards48
 Inserting a memory card..... 48
Initializing Memory Cards (Format)49
**Saving Samples to Memory Cards
(Sample Save).....49**
**Loading Sample from a Memory Card
(Sample Load)50**
**Saving Patterns to Memory Cards
(Pattern Save)50**
**Loading Pattern from a Memory Card
(Pattern Load).....51**
**Protecting the Data on Memory Cards
(Protect)51**
**Importing Wave Data to the SP-303
From a Computer52**

**Chapter 7. Using the SP-303
With Other MIDI Devices 53**

Using the SP-303 With a MIDI Keyboard..... 53
How to Change the MIDI Channel..... 53
Note On Operating With MIDI..... 54
**Using the SP-303 With a MIDI Sequencer
(Tempo Sync) 54**
 Synchronizing the Pattern's Tempo and Start/Stop
to the MIDI Sequencer..... 54
 Synchronizing Only the Pattern Tempo
with a MIDI Sequencer..... 55
 Playing Samples Without Synchronizing the Tempo.... 55
Using the SP-303 as a Rhythm Sound Module.... 56
Using the SP-303 With a Rhythm Machine 56
 Synchronizing the Performance of the
SP-303's Patterns with a Rhythm Machine's Tempo 56
 Using the Note Messages from the Rhythm Machine
to Play the SP-303's Samples 57
Restoring the MIDI Settings to the Factory Settings... 58

**Chapter 8.
Examples of Using the SP-303 59**

**Using Pattern Sequencer to Create a
Rhythm Pattern 59**
Using the SP-303 with MIDI Devices 61
 Using the SP-303 as a rhythm sound module..... 61
Using the SP-303 With a Turntable..... 62
 Adding Effects to the Turntable Sound 62
 Playing a Sample Along With the Sound From a
Turntable 63

Appendices 64

Chart of Operations 64
Troubleshooting..... 66
Initializing the SP-303's Memory 68
Message List..... 69
MIDI Implementation Chart..... 71
Specifications..... 72

Index 73

Main Features

High-Capacity Memory Cards (SmartMedia) for Extended Sampling Times

The SP-303 itself provides up to three minutes and twelve seconds of sampling.

In addition, by using optional memory cards (SmartMedia: 8 MB–64 MB) you can sample for much longer lengths of time.

For example, using a 64 MB SmartMedia card in Standard mode gives you 33 minutes of samples, and in Lo-Fi mode, you can get up to 200 minutes.

* 1 MB, 2 MB, and 4 MB SmartMedia cards cannot be used.

* SmartMedia is a trademark of Toshiba Corporation.

26 Internal Effects Perfect for Groove Music

The SP-303 features twenty-six internal effects that are indispensable for creating and performing Groove music, including a Vinyl Simulator that mimics the sonic qualities of analog records, filter effects that are essential in Techno music, an Isolator effect—a must for remixing—a powerful voice transformer for vocal effects, and more.

You can also use these effects on sounds input from external sources as well.

Eight-Voice Polyphony

Using mono samples, you can have up to eight voices playing simultaneously. What's more, you can use effects and memory cards with no reduction in polyphony, so you get plenty of room to work with, even in performances using layered samples with effects added.

Resampling? No Problem

Resampling the playback of sampled sounds with internal effects added lets you create even more new sounds. And since the process is entirely digital, there is no degradation in sound quality. This makes it convenient to create different variations from sounds that have already been sampled.

Automated Playback of Sampled Sounds (Pattern Sequencer)

You can run a playback of some sampled sounds, and then play back the sequence of sounds as a single pattern.

This lets you easily create combinations of rhythms and samples, and combine different phrases to create a single song.

■ Printing Conventions in This Manual

- Text or numerals enclosed in square brackets [] indicate buttons or pads.

[REC] REC button

BANK [A] Bank A button

[1] Pad 1

[HOLD] Hold pad

- Reference such as (p. **) indicate pages in this manual to which you can refer.
-

Panel Descriptions

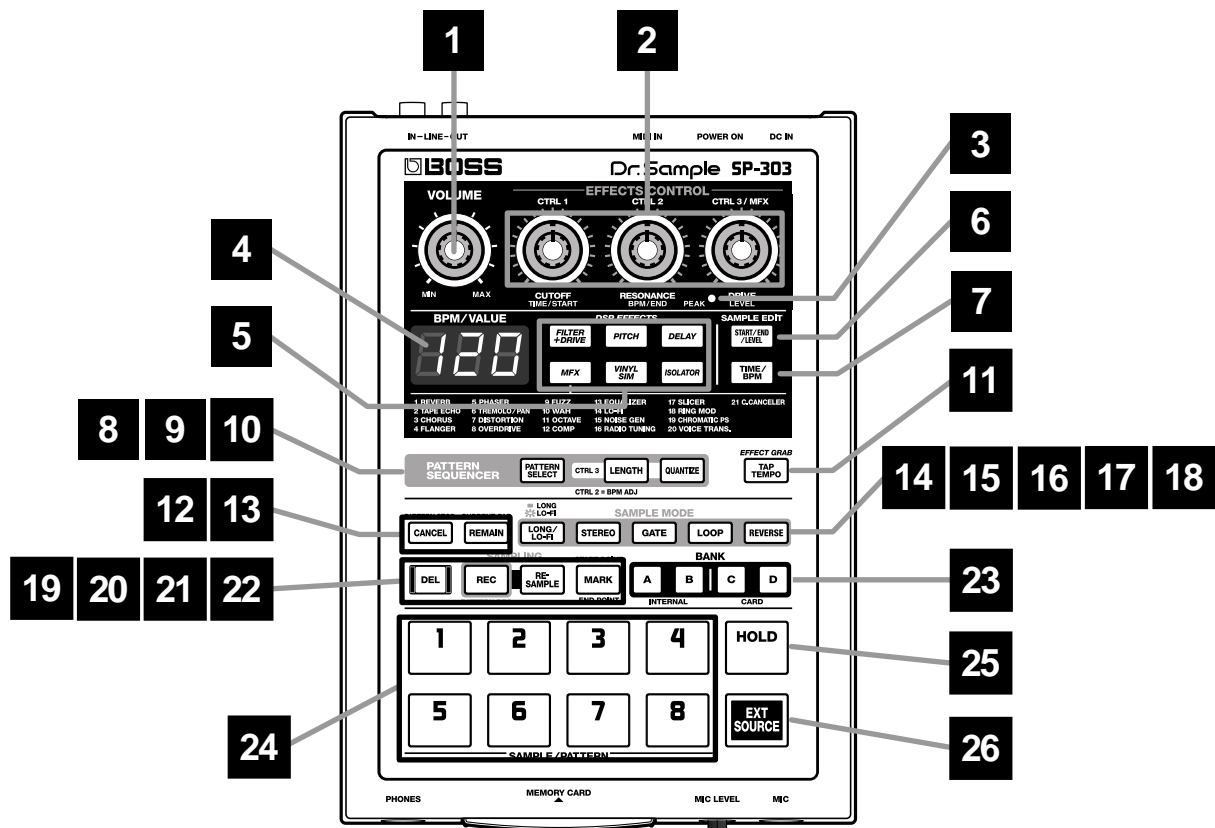

1 VOLUME Knob

Adjusts the volume level of the LINE OUT and headphones jacks.

2 EFFECTS CONTROL Knobs

Control the parameters assigned to each of the knobs associated with the selected effect. Also use the knobs in the following situations.

CTRL 1(Control 1) Knob

Use this to change the sample's starting point and the playback time of the sample.

CTRL 2 (Control 2) Knob

Use this when changing the BPM (tempo) of the pattern or when changing the point when the sound of the sample is to stop.

CTRL 3/MFX (Control 3/MFX) Knob

Use this when selecting the MFX type, or when changing the sampling level or sampling volume.

3 PEAK Indicator

This indicator helps you to adjust the level when sampling. For optimal sampling, adjust the level so that this indicator lights occasionally.

4 Display

Displays sample and pattern BPM (tempo), settings values, error messages, and other information. You can also have the remaining time available for sampling displayed.

5 EFFECTS Buttons

Select the effects you wish to use. A button is lit when its effect is on; the light goes out when the effect is turned off.

* *It is not possible to apply two or more effects simultaneously.*

6 START/END/LEVEL Button

Use this to change the point where the sample is to start and end, and to adjust the level.

7 TIME/BPM Button

Use this to set the length of the playback time and the BPM (tempo).

8 PATTERN SELECT Button

Press this when playing back or recording patterns. When this button is lit, you can select patterns by pressing the pads.

9 LENGTH (Pattern Length) Button

Specifies the length of the pattern.

10 QUANTIZE Button

Corrects (quantizes) the timing of the pattern recordings automatically.

11 TAP TEMPO Button

Tap this button a number of times to change the tempo so it accords with the timing you used while tapping it.

12 CANCEL Button

By pressing this button you cancel sampling or erasing samples in progress.

You can also stop playback of the pattern in progress.

13 REMAIN Button

When this button is pressed, the display will indicate the remaining time available for sampling.

Additionally, by pressing pads while holding down this button, you can select the samples for which you want to add effects or change settings.

14 LONG/LO-FI Button

Switches the sampling grade (high-quality/extended time/Lo-Fi).

Extended time is selected when the button is lit, high-quality when the button is not lit, and Lo-Fi when the button is blinking.

15 STEREO Button

Specifies whether sampling will be mono or stereo.

When the button is lit, sampling is in stereo; when not lit, sampling is mono.

16 GATE Button

This switches between "Gate Playback," where samples play only while the pad is held down, and "Trigger Playback," whereby the pad is pressed to toggle between play and stop of the sample.

Gate Playback is in effect when the button is lit; when not lit, Trigger Playback is in effect.

17 LOOP Button

This switches between "Loop Playback," where samples play repeatedly when the pad is pressed, and "One Shot Playback," in which the sample is played only one time.

Loop Playback is in effect when the button is lit; when not lit, One Shot Playback is in effect.

18 REVERSE Button

This switches the SP-303 to "Reverse Playback," where samples are played backwards.

Reverse Playback is in effect when the button is lit; when not lit, normal Playback is in effect.

19 DEL (Delete) Button

Use this button to delete a sample or pattern. The button lights up while the deletion is in progress.

20 REC (Recording) Button

Use this when starting and stopping sampling, and when starting and stopping recording patterns.

21 RESAMPLE (Resampling) Button

Use this when creating new samples made by playing back previous samples with effects added (resampling).

22 MARK Button

Use this button when you wish to sound only a portion of a sampled sound. While this button is lit, only the specified portion will sound.

23 BANK Buttons A/B/C/D

When the PATTERN SELECT button is not lit, these switch sample banks; when PATTERN SELECT is lit, the buttons switch pattern banks.

The SP-303's internal Bank A or B is selected by pressing A or B. Press C or D to select Bank C or D on the memory card.

24 Pads (1-8)

When [PATTERN SELECT] is not lit, pressing a pad plays the sample assigned to that pad. The pad is lit while the sample plays.

When [PATTERN SELECT] is lit, pressing the pad plays back and stops the playback of patterns.

25 HOLD Pad

If you hold down this pad while pressing another pad, the sample will continue to play even after you release the pad.

26 EXT SOURCE (External Source) Pad

By using this pad you can sound/silence the sound from an external input without having to sample it, and can apply effects to the sound.

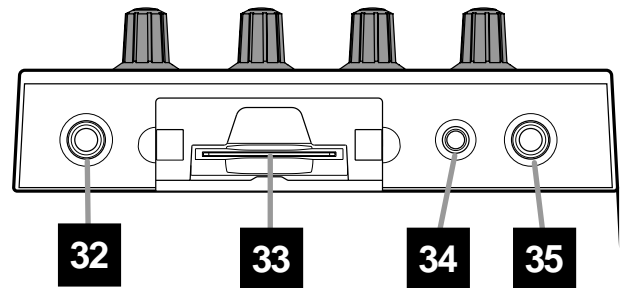
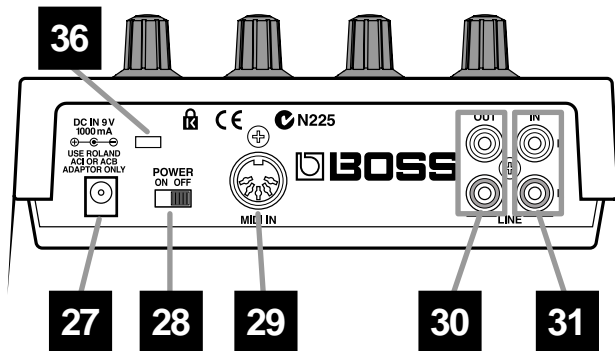

27 AC Adaptor Jack

Connect the AC adapter to this connector.

* Be sure to use only the specified AC adaptor. Doing so may damage the unit.

28 Power Switch

Turns the power on/off.

29 MIDI IN Connector

You can connect an external MIDI device (such as a sequencer, keyboard, or rhythm machine), and use the device to control the SP-303. Use MIDI cable (sold separately) to make connections.

30 LINE OUT Jacks (L/R)

These audio outputs are RCA phono type jacks for connection to an amp or mixer through which you wish to play the sampled sounds.

31 LINE IN Jacks (L/R)

RCA phono type audio input jacks for connecting a CD player or other source device used for taking samples.

32 PHONES (Headphones) Jack

A set of headphones can be connected here to hear the same sound as the line outputs. The jack accepts stereo 1/4 inch phone plug.

33 MEMORY CARD Slot

A memory card (SmartMedia: optional) can be inserted here. It is also possible to use card banks C/D to record long samples that the internal memory could not accommodate.

A card can be used to store (backup) the data from internal memory.

34 MIC LEVEL Knob

Adjusts the volume of the mic sound.

35 MIC Jack

Connect a microphone.

36 Security Slot (K)

Web: www.kensington.com

IMPORTANT NOTES

In addition to the items listed under “USING THE UNIT SAFELY” on page 2–3, please read and observe the following:

Power Supply

- Do not use this unit on the same power circuit with any device that will generate line noise (such as an electric motor or variable lighting system).
- The AC adaptor will begin to generate heat after long hours of consecutive use. This is normal, and is not a cause for concern.
- Before connecting this unit to other devices, turn off the power to all units. This will help prevent malfunctions and/or damage to speakers or other devices.

Placement

- Using the unit near power amplifiers (or other equipment containing large power transformers) may induce hum. To alleviate the problem, change the orientation of this unit; or move it farther away from the source of interference.
- This device may interfere with radio and television reception. Do not use this device in the vicinity of such receivers.
- Do not expose the unit to direct sunlight, place it near devices that radiate heat, leave it inside an enclosed vehicle, or otherwise subject it to temperature extremes. Excessive heat can deform or discolor the unit.
- To avoid possible breakdown, do not use the unit in a wet area, such as an area exposed to rain or other moisture.

Maintenance

- For everyday cleaning wipe the unit with a soft, dry cloth or one that has been slightly dampened with water. To remove stubborn dirt, use a cloth impregnated with a mild, non-abrasive detergent. Afterwards, be sure to wipe the unit thoroughly with a soft, dry cloth.
- Never use benzine, thinners, alcohol or solvents of any kind, to avoid the possibility of discoloration and/or deformation.

Additional Precautions

- Please be aware that the contents of memory can be irretrievably lost as a result of a malfunction, or the improper operation of the unit. To protect yourself against the risk of losing important data, we recommend that you periodically save a backup copy of important data you have stored in the unit’s memory on a Memory card (SmartMedia).
- Unfortunately, it may be impossible to restore the contents of data that was stored in the unit’s memory, and on a Memory card (SmartMedia) once it has been lost. Roland Corporation assumes no liability concerning such loss of data.
- Use a reasonable amount of care when using the unit’s buttons, sliders, or other controls; and when using its jacks and connectors. Rough handling can lead to malfunctions.

- Never strike or apply strong pressure to the display.
- When connecting / disconnecting all cables, grasp the connector itself—never pull on the cable. This way you will avoid causing shorts, or damage to the cable’s internal elements.
- To avoid disturbing your neighbors, try to keep the unit’s volume at reasonable levels. You may prefer to use headphones, so you do not need to be concerned about those around you (especially when it is late at night).
- When you need to transport the unit, package it in the box (including padding) that it came in, if possible. Otherwise, you will need to use equivalent packaging materials.
- Use a cable from Roland to make the connection. If using some other make of connection cable, please note the following precautions.
 - Some connection cables contain resistors. Do not use cables that incorporate resistors for connecting to this unit. The use of such cables can cause the sound level to be extremely low, or impossible to hear. For information on cable specifications, contact the manufacturer of the cable.

Before Using Cards

Using Memory Cards

- Never insert or remove a memory card while the power to the SP-303 is on.
- Carefully insert the Memory card all the way in—until it is firmly in place.

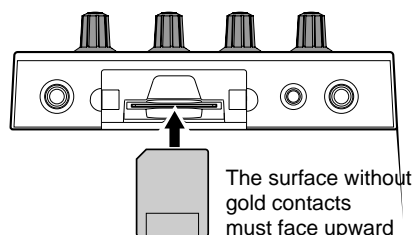

- Never touch the terminals of the DATA card. Also, avoid getting the terminals dirty.

Copyright

- Unauthorized recording, distribution, sale, lending, public performance, broadcasting, or the like, in whole or in part, of a work (musical composition, video, broadcast, public performance, or the like) whose copyright is held by a third party is prohibited by law.
- Do not use this unit for purposes that could infringe on a copyright held by a third party. Roland assumes no responsibility whatsoever with regard to any infringements of third-party copyrights arising through your use of this unit.

QUICK START

Making Connections

The SP-303 does not contain an amp or speaker. To hear sound, either connect an amplifier and speakers or use headphones. Refer to the following diagram and connect the SP-303 to the other equipment.

- * Audio cables, MIDI cables, stereo headphones, and microphones are not included. These may be purchased separately from your dealer.
- * To prevent malfunction and/or damage to speakers or other devices, always turn down the volume, and turn off the power on all devices before making any connections.

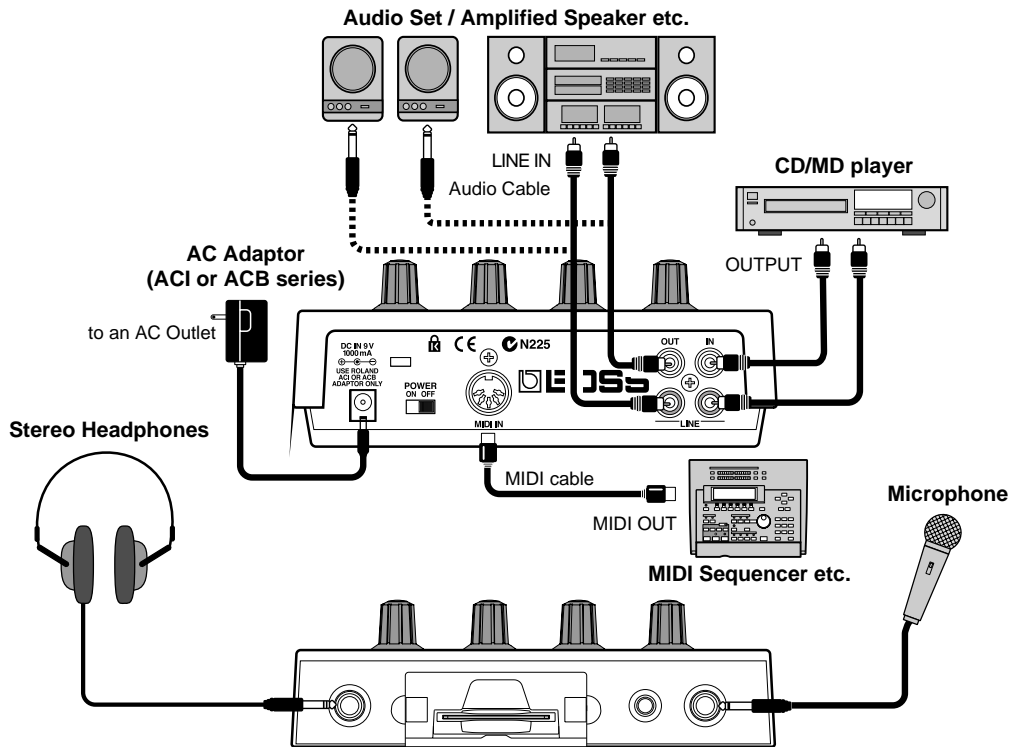

DJ system setup

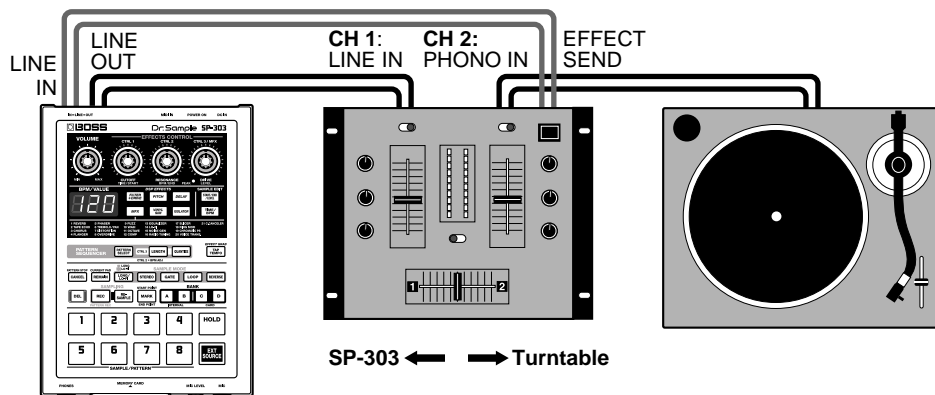

When sampling from a record, set the mixer fader to the Turntable position (maximum).

The volume level during sampling is adjusted by the SP-303's REC level (p. 28, 30) and by the mixer's effect send level.

Mixer settings

CH 1 Input: line Effect: OFF
 CH 2 Input: PHONO Effect: ON

- * Settings may be different depending on the mixer. For details refer to the owner's manual for your mixer.

Turning On the Power

Once the connections have been completed (p. 11), turn on power to your various devices in the order specified. By turning on devices in the wrong order, you risk causing malfunction and/or damage to speakers and other devices.

1. Before you turn the power on, check the following points.

- Are peripheral devices connected correctly?
- Are the volume levels on the SP-303 and any amp or mixer that is connected turned down to the lowest settings?

2. Turn the SP-303's power switch ON.

"303" appears on the display for a few seconds. The **dots** will also blink.

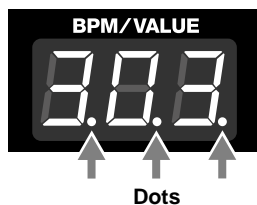
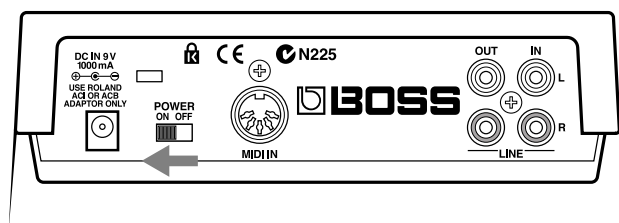

- 3. Turn on the power of your amp/mixer etc.**
- 4. Rotate the VOLUME knob to adjust the SP-303's volume.**

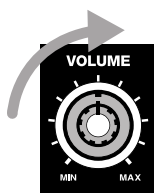

5. Also adjust the volume of the connected amp/mixer etc.

- * This unit is equipped with a protection circuit. A brief interval (a few seconds) after power up is required before the unit will operate normally.
- * If you turn on the power with a memory card already inserted, the dots will blink until the memory card is detected. The unit will not operate during this time.



Never turn off the power while the dots are blinking.

Turning Off the Power

- 1. Before you turn off the power, make sure that the volumes of the SP-303 and the connected amp/mixer are set to their minimum position.**
- 2. Turn off the power of the amp/mixer etc.**
- 3. Turn off the power switch of the SP-303.**



Never turn off the power while the dots are blinking. This may result in corruption of data in the SP-303's internal memory or on memory cards.

Listen to the Samples

When the SP-303 is shipped from the factory, 1–8 of bank A already contain samples. Let's listen to these samples.

● What is a sample?

A sample is a piece of sampled sound (a “waveform”) together with various settings that determine how it can be played during a performance, which has been assigned to a pad.

● What is a Sample Bank?

The samples that are assigned to each of the eight pads are collectively referred to as a bank. The SP-303 has four sample banks: A–D.

- * The SP-303 is able to sound up to eight pads simultaneously. If you press additional pads in an attempt to play more, the sound of the first-pressed pad will be turned off (pad dark) to make way for the newly-pressed pad (last-note priority). However depending on the settings, it may not be possible to sound eight pads simultaneously. For more detailed instructions, refer to “Number of Samples That Can Be Played Simultaneously (Polyphony)” (p. 18).
- * Once deleted, the samples assigned in the factory settings cannot be recovered. If there is any data you wish to retain, purchase a memory card (SmartMedia: 8 MB–64 MB) separately, then save the pattern to the memory card. For instructions on saving samples to memory cards, refer to “Saving Samples to Memory Cards (Sample Save)” (p. 49).

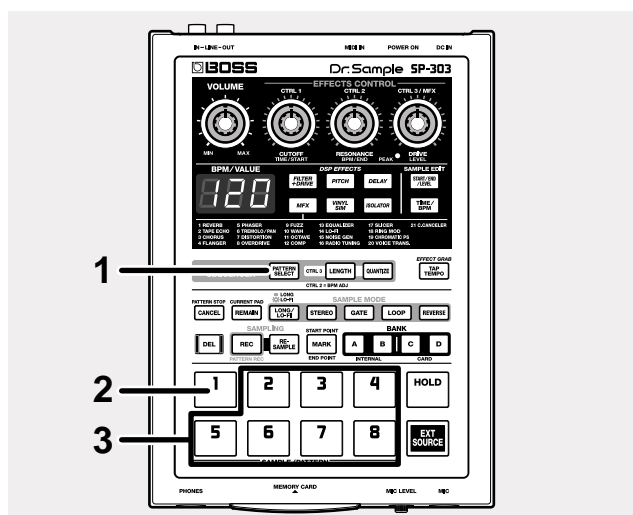

1. Confirm that [PATTERN SELECT] is not lit.
If [PATTERN SELECT] is lit, press it so that the button's light goes out.
 2. Press pad 1.
The pad will remain lit while the sample is playing.
 3. After verifying that you hear the sound, try pressing pads 2–8 as well.
- * If pressing a pad does not produce sound, make sure that sample bank A is selected (BANK [A] is lit). If a different bank is selected, press the BANK [A] button to switch to bank A.
 - * The volume does not change in response to playing dynamics. Applying excessive force to a pad will cause malfunctions. For more on how to adjust sample volume levels, refer to “Setting the Sample Volume” (p. 38).

Adding Effects to Samples

The SP-303 has 26 effects which can add special characters to the sound.

Here's how to try out these effects and hear what they can do.

Of the twenty-six effects, you can select five of them—Filter + Overdrive, Pitch Shifter, Delay, Vinyl Simulator, and Isolator—by directly pressing their buttons.

The other twenty-one effects are grouped together in MFX (the multi-effects). Hold down [MFX] and turn the CTRL 3/MFX knob to select which of these twenty-one effects is to be used.

Here, try applying Filter + Overdrive to the sample.

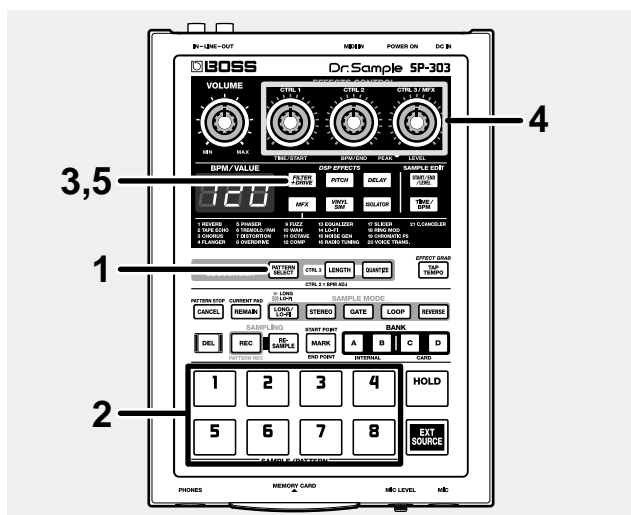

1. **Confirm that [PATTERN SELECT] is not lit.**
If [PATTERN SELECT] is lit, press it so that the button's light goes out.
2. **Press the pad which contains the sample to which you wish to apply Filter + Overdrive effect.**
The pad will light, and the sample will sound.
3. **Press [FILTER+DRIVE], and confirm that the button has lit.**
The Filter + Overdrive are applied to the sample sound.

4. **Turn the CTRL 1–3 knobs to adjust the amount of Filter + Overdrive to be applied.**

CTRL 1 (CUTOFF):

Adjusts the filter cutoff frequency. The more the knob is turned to the left the darker the sound becomes; conversely, turning this to the right (clockwise) gives the sound a brighter, clearer feeling.

CTRL 2 (RESONANCE):

Adjusts the filter resonance. The more the knob is turned to the right, the more the sound's particular characteristics are emphasized.

CTRL 3 (DRIVE):

Adjusts the amount of distortion in the filter. The more the knob is turned to the right, the greater the amount of distortion, creating a wilder sound.

5. **To turn the Filter + Overdrive off, press [FILTER+DRIVE]; the light goes out.**

For explanations of the Pitch Shifter, Delay, Vinyl Simulator, and Isolator effects, as well as instructions for selecting effects used in MFX and the workings of these effects, refer to "Chapter 2 Using the Effects" (p. 21).

Try Playing a Pattern

With the SP-303, you can press a number of pads in sequence to play a series of samples, and record that sequence as played. Such a sequential arrangement of performed samples is called a “**pattern.**”

At the factory settings, a demo pattern is assigned to Pad 1 in Pattern Bank A. Try listening to this pattern.

- * All rights reserved. Unauthorized use of this material for purposes other than private, personal enjoyment is a violation of applicable laws.
- * Once deleted, the demo pattern cannot be recovered. If you want to keep the demo pattern, purchase a memory card (SmartMedia: 8 MB–64 MB) separately, then save the pattern to the memory card. For instructions on saving samples to memory cards, refer to “Saving Patterns to Memory Cards (Pattern Save)” (p. 50).

● Pattern Banks

Just as with the samples, patterns are assigned to the pads. A set of patterns assigned to the eight pads is treated collectively as a “pattern bank.”

The SP-303 has four pattern banks: A–D.

Pattern banks and sample banks are different. For example, you do not necessarily need to use Bank A samples in Pattern Bank A.

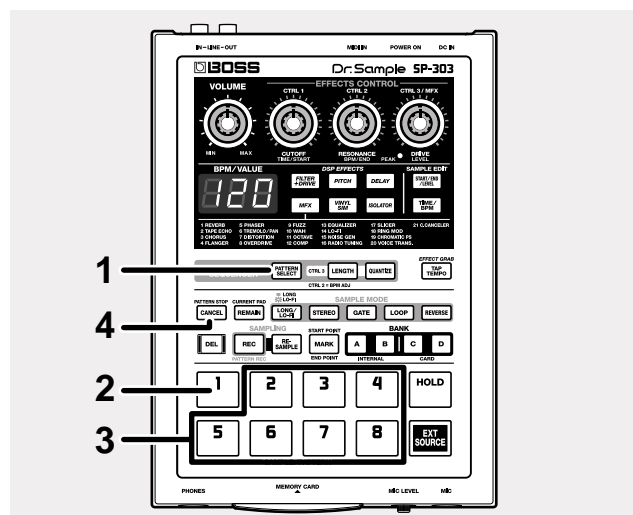

1. Press [PATTERN SELECT], and confirm that the button has lit.
“Ptn” appears in the display.

2. Press pad 1.

Pad 1 momentarily lights, then goes off, and the [PATTERN SELECT] light goes out.

The performance of the demo pattern begins.

- * If a pattern fails to start playing even when the pad is pressed, check to make sure that [PATTERN SELECT] is lit, and that Bank A is selected (BANK [A] is lit). If a different bank is selected, press [PATTERN SELECT], illuminating the button, then press BANK [A] to select Bank A.

3. After verifying that you hear the sound, try pressing pads 2–8 as well.

The sample for the pad that is pressed is played.

- * After the pattern starts playing, play of samples is enabled when the pads are pressed.

You can then play samples along with the performance of the pattern.

4. Press [CANCEL] (PATTERN STOP).

The pattern is stopped.

- * After playing or switching patterns, the play of samples is automatically enabled when the pads are pressed.

Playing with the Tempo Changed

Here’s how to change the tempo at which a pattern will be played.

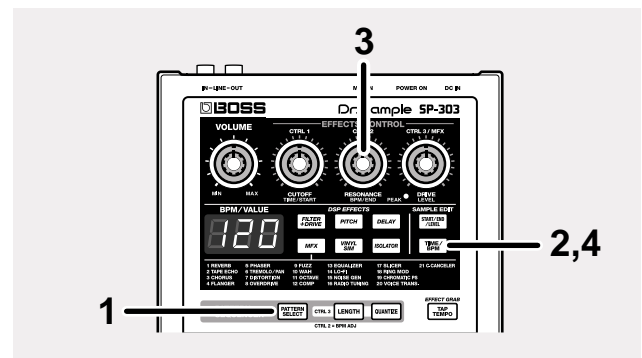

1. Press [PATTERN SELECT], and confirm that the button has lit.
2. Press [TIME/BPM], and confirm that the button has lit.
3. Turn the CTRL 2 knob.
The performance tempo of the pattern changes. The performance tempo is indicated by the BPM in the display.
? BPM is short for “beats per minute,” or the number of quarter notes played in a one-minute interval.
4. Press [TIME/BPM] once more, and confirm that the button has turned off.

Sampling Your Own Sounds

Here, let's try sampling to Pad 1 in Sample Bank B, which has had no samples assigned to it at the factory.



Unauthorized sampling from a CD, record, tape, video production, or broadcast whose copyright is owned by a third party is forbidden by law, with the exception of special cases such as private use.



Lifting the SP-303's Memory Protection

The SP-303's "Protect" (memory protection) is turned on at the factory to prevent accidental overwriting or deletion of the samples and demo pattern stored in the SP-303's memory. If you attempt to sample, delete, record patterns, or carry out other such operations while Protect is left on, "Prt" appears in the display, and no further operations are permitted. When you first sample or record after purchasing the SP-303, use the procedure below to lift the Protect function.

1. Turn off the power.
2. Hold down [CANCEL] and slide the POWER switch to ON.

This removes the protection (Protect Off).

- * The Protect setting is stored even after the power is turned off, so once you turn off the protection after purchase of the SP-303, it remains off afterwards.
- * If you want to turn Protect on again, hold down [REMAIN] while switching ON the POWER switch.

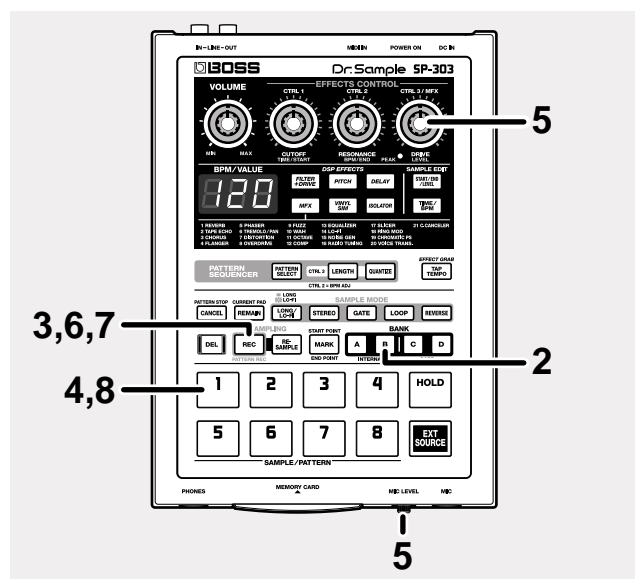

1. Refer to p. 11 for instructions on connecting CD and MD players, microphones, and other devices.

2. Press BANK [B], and confirm that the button has lit.

3. Press [REC] and confirm that the button has lit.

The SP-303 switches to sampling standby mode, and a pad that has no sample assigned to it is automatically selected and begins blinking.

- * If you now decide not to sample, press [CANCEL]. [REC] light goes out.

4. Press pad 1.

When Pad 1 is pressed, the other pad lights go out. [REC] will blink.

5. Adjust the sampling level.

- While playing back the sampled sound, then turn the CTRL 3/MFX (LEVEL) knob, adjusting the level so that the PEAK indicator lights up only from time to time.
- * If the PEAK indicator does not light even when the CTRL 3/MFX (LEVEL) knob is turned fully clockwise, it may be that the volume level of the device connected to the input is too low. While there is no particular problem with sampling under these conditions, we recommend that the volume of the connected input device be turned up until the PEAK indicator lights up from time to time.
- When sampling with a mic, turn the MIC LEVEL knob completely to the right (clockwise), then adjust the level so that the PEAK indicator lights up only from time to time.
- * If the sound input is distorted, turn the MIC LEVEL knob to the left (counterclockwise) until the sound is no longer distorted.

6. Playback of the sound you want to sample, then press [REC] at the point where you want the sampling to begin.

The [REC] button will blink, and sampling will start.

7. Press [REC] at the point you want the sampling to end. This completes the sampling, and the pad and [REC] lights go out.

- * If the available sampling time is exceeded, "FuL" appears in the display, and sampling stops automatically. Refer to the "Message List" (p. 69) for an explanation of the message content.

8. Press pad 1, and you will hear the sound that you just sampled.

If undesired sound or silence was recorded at the beginning or end of the sample, you can make settings so that only the desired portion is played back.

For more detailed information, refer to “Preventing Unneeded Portions from Being Played (Markers/Start Point/End Point)” (p. 38).

If you don't like the sampled sound

Delete the sound that you sampled, and start again from step 3. The procedure is as follows.

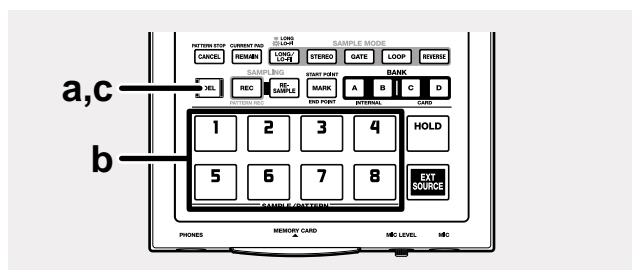

- a. Press [DEL] and confirm that the button has lit.**
The pad to which the sample is assigned blinks.
“dEL” appears in the display.
 - b. Press the pad to which the unwanted sample is assigned.**
The pad light stays on, and [DEL] blinks.
 - c. Press [DEL].**
[DEL] changes from blinking to steadily lit, and the dots in the display blink.
The deletion is complete when the dots remain off.
- * *The deletion process may take anywhere from several seconds up to around a minute to complete; please wait until the process is completed.*

NOTE

Never turn off the power while the dots are blinking. Turning off the power at this point may result in corruption of data not only in the sample that was being deleted, but in other samples as well.

Chapter 1. Playing Samples

On the SP-303, you can play samples by pressing pads 1–8 and the BANK buttons.

The pad will remain lit while the sample is playing.

The pad most recently pressed to play a sample is called the “**current pad**.” The settings information for the current pad is indicated on the panel.

MEMO

Whenever sample settings are changed, it is the sample assigned to the current pad that is affected.

Composition of Samples

One sample can be assigned to each of the Pads 1–8 on the panel. The eight samples assigned to the eight pads are collectively referred to as a “**sample bank**,” and the SP-303 allows you to use four banks, A–D. Banks A and B are the SP-303’s own internal banks, and Banks C and D are banks stored on memory cards.

* *Sample Bank A is selected when the power is turned on.*

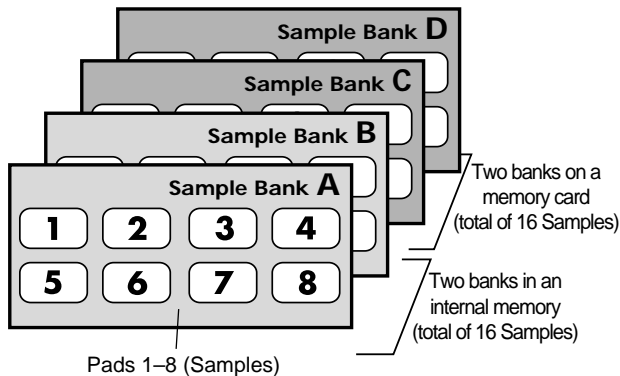

Switching Sample Banks

To switch sample banks, press one of the BANK buttons [A]–[D]. The button that is pressed lights up, and the SP-303 switches to that bank.

* *If there is no memory card inserted in the slot, you will be unable to select either Bank C or Bank D, even by pressing BANK [C] or BANK [D].*

NOTE

Never remove a memory card while samples in Bank C or D are being played. This can produce unexpected noises that may result in damage to speakers and amps. It can also damage the card itself.

When you insert an unused (i.e., unformatted on the SP-303) memory card, and press BANK [C] or [D], then BANK [C] and [D] blink, and “FMt” appears in the display.

If you want to format at this time, press BANK [C] or [D]. BANK [C] and [D] then remain lit, and [DEL] begins to blink. When you press [DEL], formatting then begins.

Formatting the memory card erases all data on the card and allows the card to be used with the SP-303.

Furthermore, do not turn off the power or remove the memory card during formatting (while [DEL] is lit).

Number of Samples That Can Be Played Simultaneously (Polyphony)

The SP-303 can play up to eight samples simultaneously (eight-voice polyphony). However, when a sample is set to stereo, the sample uses two of these voices.

* *A sample’s stereo/mono setting can only be made when sampling, and cannot be changed later on. For instructions on making settings when sampling, refer to “Sampling from a CD or MD” (p. 29).*

Also note that the maximum polyphony during resampling is four voices.

* *For more information on resampling, refer to “Making Samples with Effects Added (Resampling)” (p. 32).*

Number of Samples That Can Be Played Simultaneously

	Mono Sample	Stereo Sample
At Normal Use	8	4
During Resampling	4	2

Having a Sample Continue to Play Even When the Pad is Released (Hold)

You can use the Hold function to cause the sample to continue sounding even after you release the pad.

This is convenient for continuous repeat play of samples (Loop Playback: p. 36).

In the following procedure, we will explain how to use the Hold function with the sample on Pad 1 of Bank A as an example.

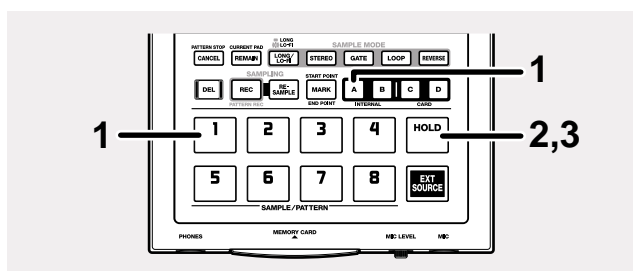

1. Make sure that BANK [A] is lit, and press pad [1] to sound the sample.
2. Press [HOLD] before releasing the pad.
This turns on Hold, and the sample will continue to sound even after you release the pad.
* Even though Hold is in effect, [HOLD] does not light.
3. Press the [HOLD] pad once again to stop the sound.
* The pad will remain lit while the sample is playing.

HINT

Hold is valid only for samples set for Gate Playback (when [GATE] is lit). With samples set for Trigger Playback ([GATE] not lit), there will be no change in function even if [HOLD] is pressed.

Gate playback/Trigger playback can be specified independently for each pad. For more detailed information, refer to p. 36.

Playing Sounds Input From External Devices (EXT SOURCE Pad)

Just as with samples, you can use the SP-303 to control the start and stop of sound from external sources, including CD or MD players and other device connected to the AUX IN jack, and miked sounds input from the MIC jack; you can also add effects to these sounds.

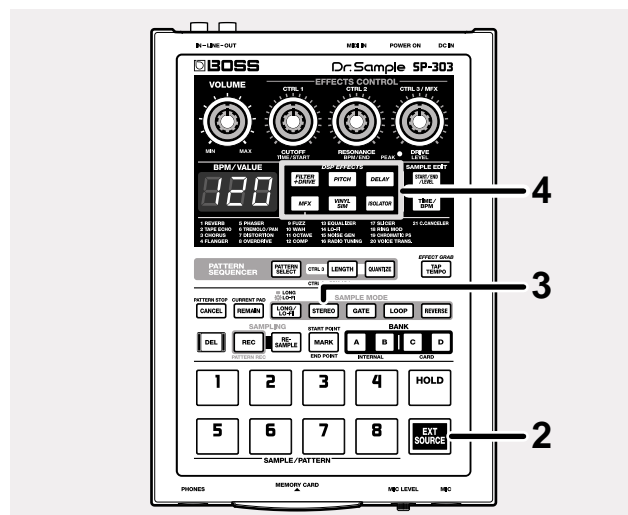

1. Start playback of the CD or MD. Alternatively, input vocals from the mic.
2. Press [EXT SOURCE], and confirm that the pad has lit.
The external input sounds while the pad remains lit.
If [GATE] is lit, the sound will be heard only while you press the [EXT SOURCE] pad, and it will be silenced when you release the pad (the pad will go dark).
If [GATE] is not lit, you can press [EXT SOURCE] to toggle between sounding the sounds (pad lighted), and muting them (pad extinguished).
GATE is illuminated/extinguished by pressing [GATE].
3. Press [STEREO], and confirm that the button has turned on or off, to switch between stereo and mono external input.
[STEREO] lit:
Sounds from the external input are heard in stereo.
[STEREO] not lit:
Sounds from the external input are heard in mono.
With CDs, MDs, and other input originally recorded in stereo, you will want to have [STEREO] lit.
4. You can add effects to the external input sounds by pressing one of the effects buttons, lighting that button.
* If pressing an effects button still does not add effects to the external input sounds, hold down [REMAIN] (CURRENT PAD) and press [EXT SOURCE]. This should apply the effect to the external input.

Adjusting the Volume of the External Input Sounds

If excessive input volume levels causes the sound to be distorted, or if noise becomes noticeable because levels are too low, use the following procedure to adjust the volume.

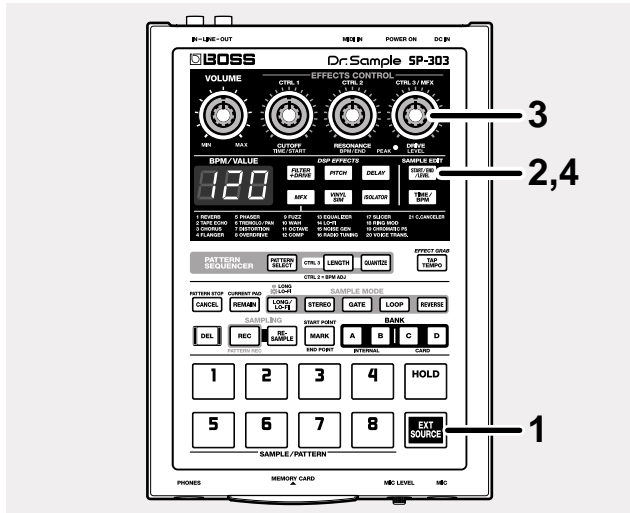

1. Press [EXT SOURCE], and confirm that the pad has lit.
The external input sounds are played.
2. Press [START/END/LEVEL], and confirm that the button has lit.
3. Turn the LEVEL knob (the CTRL 3/MFX knob) to adjust the volume of the external input sounds.
Rotating it toward the left will decrease the volume, and rotating it toward the right will increase the volume. Adjust the level so that the PEAK indicator lights occasionally.
* If the input volume of the external source does not change even when you rotate the LEVEL knob (the CTRL 3/MFX knob), hold down [REMAIN] and press [EXT SOURCE] (this selects the external input as the target for volume adjustment). Afterwards, press [START/END/LEVEL] again, and make the adjustment with the LEVEL knob.
4. Press [START/END/LEVEL] again.
The [START/END/LEVEL] light goes out, and the volume setting is stored.
* At times, the volume level of sounds from a CD, MD, or other such source may be too high, or if you are using a mic, distortion may still be audible even after adjusting the volume, or conversely, that you cannot get enough volume in the sound. In such situations, adjust the volume of the CD or MD player, or if using a microphone, turn the MIC LEVEL knob, adjusting the volume until you achieve the proper level.

Chapter 2. Using the Effects

The SP-303 features twenty-six internal effects, so you can add effects to samples to alter the sounds, just with this one unit.

- Of the twenty-six effects, you can select five of them—Filter + Overdrive, Pitch Shifter, Delay, Vinyl Simulator, and Isolator—by directly pressing their buttons. The other twenty-one effects are grouped together in MFX (the multi-effects). By holding down [MFX] and turning the CTRL 3/MFX knob, you can select which of these twenty-one effects that is to be used.
- You can have any one effect turned on at a given time. Multiple effects cannot be on simultaneously. If you do want to use multiple effects on a sample, or if you need to have a different effect applied to each individual effect, then use “**resampling.**” Resampling allows you to use a sample that has effects added to it as a new sample. For more detailed information, refer to “Making Samples with Effects Added (Resampling)” (p. 32).

Adding Effects to Samples

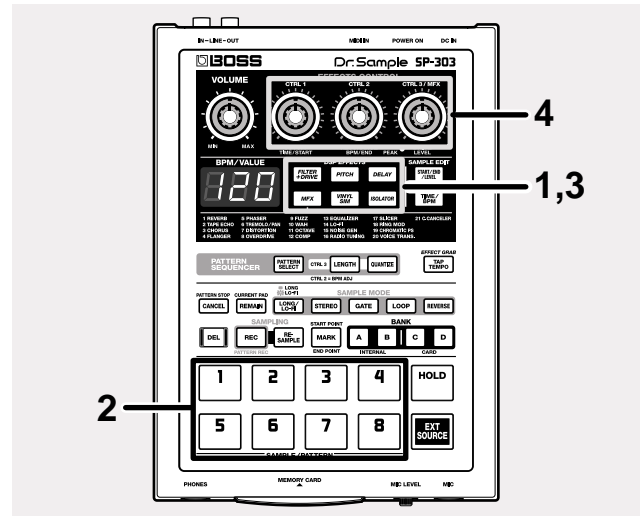

1. **Confirm that none of the effect buttons is lit.**
If any of these buttons is lit, press it so that the light goes off.
2. **Press the pad which contains the sample to which you wish to apply effects.**
The pad will light, and the sample will sound. This pad becomes the current pad.
3. **Press one of the effects buttons.**
The pressed button will light.
An effect is on when the button is lit, and off when it is dark.
** With certain effects, there may be a slight delay after the effect is turned on before the effect is applied.*
4. **Turn the CTRL 1–3/MFX knobs to adjust the application of the effect.**
The settings adjusted by turning the CTRL 1–3/MFX knobs change according to the selected effect. For more detailed information, refer to “Effects List” (p. 24).

Turning Effects On and Off Rapidly (Effect Grab)

When using the regular effects buttons, since the effects are turned on or off each time these buttons are pressed, it means that if you want to have an effect repeatedly turned on and off, you then have to press the button many times. This can be difficult, particularly when repeatedly turning the effect on and off over a short interval.

In such cases, use the **Effect Grab function**.

To use the Effect Grab function, hold down [TAP TEMPO] (EFFECT GRAB) and press the effect button.

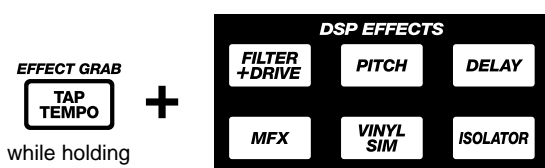

while holding

With [TAP TEMPO] (EFFECT GRAB) held down, the effect is on only while the effect button is pressed, thus allowing you to turn effects on and off rapidly in time with what you are playing.

Selecting an Effect From MFX

Use the following procedure to select the effect from MFX (the MFX type) that you want to use.



1. **Hold down [MFX] and turn the CTRL 3/MFX knob.**
The number indicating the MFX type, from 1 to 21, appears in the display. Rotating the knob toward the right will increase the number, and rotating it toward the left will decrease the number.
2. **When the number for the MFX type you want to select is displayed, release [MFX].**
[MFX] lights up, and the MFX is turned on.

Applying Effects to Multiple Samples

Normally, when an effect is turned on, the effect is applied only to the sample assigned to the current pad, with no other samples using the effect.

However, with the procedure described below, you can apply effects to multiple effects, including that of the current pad.

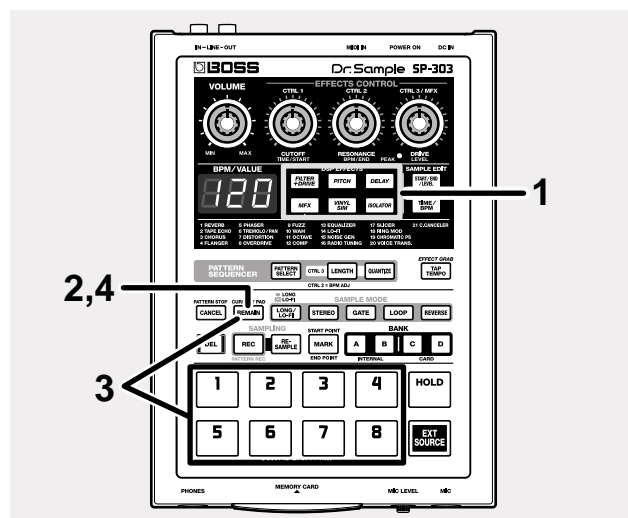

1. **Press the button for the effect to be used, and confirm that the button has lit.**
2. **Press [REMAIN] (CURRENT PAD).**
The current pad blinks.
3. **While holding down [REMAIN] (CURRENT PAD), press the pads for which you want to apply the effect, in order.**
The pressed pad blinks and becomes the new current pad.
All pressed pads other than the current pad remain lit.

	Effect
Pad Lit	O
Pad Not Lit	X
Current Pad: Long blinks	O
Current Pad: Short blinks	X

The effect for a pad is alternately switched on and off each time the same pad is pressed while [REMAIN] (CURRENT PAD) is held down.

4. **When you have pressed the pads for all samples to have the effect applied, release [REMAIN] (CURRENT PAD).**

* You cannot apply a different effect to each pads.

Applying Effects to All Samples Simultaneously

If you want an effect to be applied to all of the pads at once, it would be time consuming if you needed to press all the pads. Thankfully, though, a simple procedure you can use when applying an effect to all of the pads has been provided.

* *This operation applies the effect to all pads in Banks A–D.*

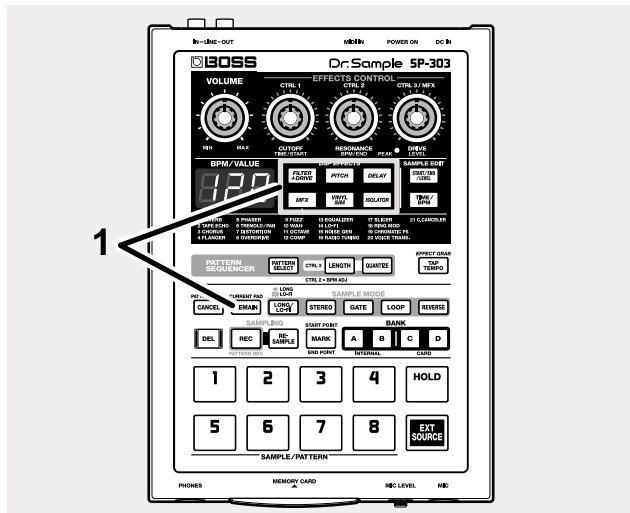

1. While holding down [REMAIN] (CURRENT PAD), press the button for the effect to be used.

The pressed effect button blinks.

All of the pads light up (the current pad blinks), and the effect is applied to all of the pads.

Effect Button	Effect
Lit	The effect is applied to one or more samples.
Blinking	The effect is applied to all 32 samples (4 banks x 8 pads).

- * *A pad to which no sample is assigned doesn't light up.*
- * *To revert to having the effect applied only to the current pad, hold down [REMAIN] (CURRENT PAD) again and press the blinking effect button.*
- * *You cannot apply/remove effects for individual pads while the effect button is blinking.*

Effects List

Effects That Can Be Selected Directly With the Effects Buttons

DSP EFFECTS	CTRL 1 (display)	CTRL 2 (display)	CTRL 3 (display)
FILTER + DRIVE	CUTOFF (CoF)	RESONANCE (rES)	DRIVE (drV)
Low-pass filter with overdrive. Cuts the high frequencies and adds distortion.	Adjusts the cutoff frequency.	Adjusts the peak level at the cut-off frequency.	Adds distortion.
PITCH	PITCH (Pit)	FEEDBACK (Fdb)	DIRECT/EFFECT BALANCE (dAL)
Modifies the pitch.	Changes the pitch up or down two octaves.	Adjusts the feedback amount of the pitch shift sound.	Adjusts the volume balance between the effect sound and the direct sound.
DELAY	DELAY TIME (t32–t1)	FEEDBACK (Fdb)	E.LEVEL (LEV)
Repeats the sound.	Adjusts the time of the delayed sound. (*1)	Adjust the number of times that the delay will repeat.	Specifies the volume of the delay.
VINYL SIM	COMPRESSOR (CMP)	NOISE LEVEL (noS)	WOW FLUTTER (FLu)
Gives the sound the sonic qualities of an analog record.	Adjusts the sense of compression in the sound that is characteristic of analog records.	Adjusts the volume of analog record noise.	Adjusts the rotational irregularities that occur when playing an analog record.
ISOLATOR	LOW (Lo)	MID (Mid)	HIGH (Hi)
Extracts and deletes sounds in the low-, mid-, or high-frequency range.	Extracts/deletes sounds in the low-frequency range.	Extracts/deletes sounds in the midrange.	Extracts/deletes sounds in the high-frequency range.

(*1) Time (Delay Time) is based on the tempo for the longest of the samples to which the effect is applied; the setting is made in note units.

The types of notes that can be set:

thirty-second note	(t32)
sixteenth note	(t16)
dotted sixteenth note	(t16.)
eighth-note triplets	(t8.3)
eighth note	(t8)
dotted eighth note	(t8.)
quarter-note triplets	(t4.3)
quarter note	(t4)
dotted quarter note	(t4.)
half-note triplets	(t2.3)
half note	(t2)
dotted half note	(t2.)
whole note	(t1)

However, you cannot select delay time settings exceeding approximately 1450 milliseconds.

In addition, playback of a pattern is based on the pattern's tempo.



MFX

DSP EFFECTS	CTRL 1 (display)	CTRL 2 (display)	CTRL 3 (display)
1. REVERB	REVERB TIME (tiM)	TONE (ton)	E.LEVEL (LEV)
Adds reverberation to the sound	Adjusts the time of reverb.	Adjusts the quality of the reverb.	Adjusts the volume of the reverb.
2. TAPE ECHO	REPEAT RATE (rAt)	INTENSITY (int)	E.LEVEL (LEV)
Vintage tape echo effect.	Sets the tape speed.	Sets the amount of repetition of the echo sound.	Adjusts the volume of the echo sound.
3. CHORUS	DEPTH (dPt)	RATE (rAt)	E.LEVEL (LEV)
Adds spaciousness and depth to the sound.	Sets the depth of the chorus.	Specifies the rate of modulation.	Adjusts the volume of the effect sound.
4. FLANGER	DEPTH/MANUAL (dPt)	RATE (rAt)	RESONANCE (rES)
Adds a undulation like that of a jet ascending or descending.	Adjusts the depth of the undulation. When the CTRL 2 knob (RATE) is turned fully counterclockwise, pitch (MANUAL) is adjusted.	Adjusts the rate of the undulation. When turned fully counterclockwise, the undulation stops, and the pitch (MANUAL) can be adjusted with the CTRL 1 knob (DEPTH).	Adds a particular undulation to the sound.
5. PHASER	DEPTH/MANUAL (dPt)	RATE (rAt)	RESONANCE (rES)
Adds a kind of cyclic undulation to the sound.	Adjusts the depth of the undulation. When the CTRL 2 knob (RATE) is turned fully counterclockwise, pitch (MANUAL) is adjusted.	Adjusts the rate of the undulation. When turned fully counterclockwise, the undulation stops, and the pitch (MANUAL) can be adjusted with the CTRL 1 knob (DEPTH).	Adds a particular undulation to the sound.
6. TREMOLO/PAN	DEPTH (dPt)	RATE (rAt)	TREMOLO/PAN WAVEFORM (trM/PAn)
Cyclically changes the volume or pan.	Adjusts the amount of change in the volume or pan.	Adjusts the rate of change in the volume or pan.	Changes the periodic curve of the change in volume or pan. When turned counterclockwise, it is the volume that changes; when turned clockwise, the pan changes.
7. DISTORTION	DRIVE (drV)	TONE (ton)	LEVEL (LEV)
Strongly distorts the sound.	Adjusts the depth of distortion.	Adjusts the tonal character.	Specifies the volume.
8. OVERDRIVE	DRIVE (drV)	TONE (ton)	LEVEL (LEV)
Mildly distorts the sound.	Adjusts the depth of distortion.	Adjusts the tonal character.	Specifies the volume.
9. FUZZ	DRIVE (drV)	TONE (ton)	LEVEL (LEV)
Adds harmonics and distorts the sound.	Adjusts the depth of distortion.	Adjusts the tonal character.	Specifies the volume.
10. WAH	SENS (SnS)	FREQUENCY (Frq)	RESONANCE (rES)
Produces a “wah” effect	Adjusts the sensitivity of the Wah effect.	Adjusts the pitch of the effect sound.	Adjusts the wah’s peak volume.
11. OCTAVE	-2OCT LEVEL (oC2)	-1OCT LEVEL (oC1)	DIRECT LEVEL (dir)
Adds sound octaves lower.	Adds sound two octaves lower than the original sound.	Adds sound one octave lower than the original sound.	Adjusts the volume level of the direct sound.
12. COMP	SUSTAIN (SuS)	ATTACK (Att)	LEVEL (LEV)
Makes the volume more consistent.	Adjusts the amount of the compressor effect that is applied.	Adjusts the sound’s attack.	Specifies the volume.
13. EQUALIZER	LOW (Lo)	MID (Mid)	HIGH (Hi)
Adjusts the volume level for each individual frequency range.	Adjusts the volume of the low frequency range.	Adjusts the volume of the midrange.	Adjusts the volume of the high frequency range.
14. LO-FI	SAMPLE RATE (rAt)	BIT (bit)	FILTER (FLt)

Chapter 2. Using the Effects

DSP EFFECTS	CTRL 1 (display)	CTRL 2 (display)	CTRL 3 (display)
Gives the sound a “low-fidelity” character.	Adjusts the sampling frequency.	Adjusts the bit count.	Adjust the sensitivity with which the filter will be affected.
15. NOISE GEN	COLOR (CoL)	QUALITY (qLt)	LEVEL (LEV)
Generates noise.	Adjusts the tone of the hissing noise.	Sets how often the scratch noise is produced.	Adjust the volume level of the hissing noise.
16. RADIO TUNING	TUNING (tun)	NOISE LEVEL (noS)	FREQUENCY RANGE (Frq)
Reproduces the sound being played on the radio.	Adjusts the degree of noise that occurs when tuning a radio.	Specifies the volume of the noise.	Adjusts the tonal character.
17. SLICER	TIMING PTN (P01–16)	RATE (rAt)	FEEDBACK (Fdb)
Continuously cuts the sound. Includes a flanger effect.	Select a pattern to specify the timing at which the sound will be cut. (*2)	Adjusts the length of the TIMING PTN. (*3)	Adjusts the degree of the flanger effect.
18. RING MOD	FREQUENCY (Frq)	EFFECT LEVEL (EFF)	DIRECT LEVEL (dir)
Creates a metallic sound quality.	Adjusts the pitch of the metallic sound.	Adjusts the volume of the effect sound.	Adjusts the volume level of the direct sound.
19. CHROMATIC PS	PITCH 1 (-C–CC)	PITCH 2 (-C–CC)	DIRECT/EFFECT BALANCE (bAL)
Two-voice pitch shifter that changes the pitch in semitone steps.	Changes Pitch 1 up or down one octave in semitone intervals.	Changes Pitch 2 up or down one octave in semitone intervals.	Adjusts the balance of the effect sound and direct sound.
20. VOICE TRANS.	FORMANT (For)	EFFECT LEVEL (EFF)	DIRECT LEVEL (dir)
Processes human vocals to produce a variety of different voices.	Adjusts the vocal characteristics (formant).	Adjusts the volume level of the effect sound.	Adjusts the volume level of the direct sound.
21. C.CANCELER	L-R BALANCE (bAL)	LOW BOOST (Lo)	HIGH BOOST (Hi)
Eliminates the vocals and other sounds located at the center.	Finds the best point for deletion.	Boosts the bass and other low-frequency sounds located at the center.	Boosts the high-frequency sounds.

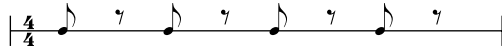
(*2) The following choices are available for TIMING PTN when the selection is made using the CTRL 1 knob, and “17. SLICER” is selected for MFX.

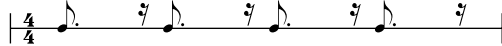
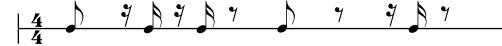
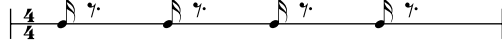
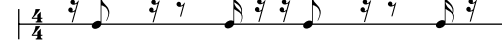
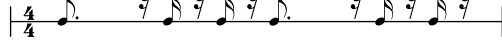
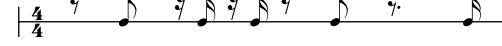
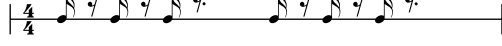
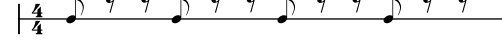
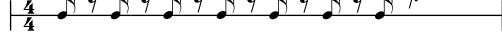
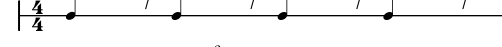
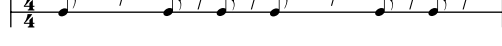
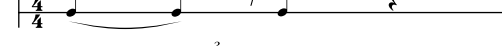
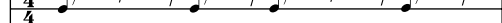
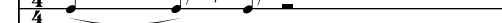
P01		P09	
P02		P10	
P03		P11	
P04		P12	
P05		P13	
P06		P14	
P07		P15	
P08		P16	

(*3) The TIMING PTN period is synchronized to the longest of the samples to which the effect is applied. However, if a pattern is being played back, then this is synchronized to the pattern tempo. The sync rate can be adjusted with the RATE setting as shown below.

With RATE at minimum (the CTRL 2 knob turned completely to the left):

one TIMING PTN cycle corresponds to one measure.

With RATE at maximum (the CTRL 2 knob turned completely to the right):

one TIMING PTN cycle corresponds to one-eighth of a measure.
You can set the cycle to one measure, one-half measure, one-quarter measure, or one-eighth measure according to the CTRL 2 knob position.

Chapter 3. Sampling

NOTE

Unauthorized sampling from a CD, record, tape, video production, or broadcast whose copyright is owned by a third party is forbidden by law, with the exception of special cases such as private use.

Before Sampling

Before you begin sampling sound, here are descriptions of the parameters to be set in the sampling process as well as sampling time.

Selecting Higher Quality Sampling, Extended Sampling, or Lo-Fi Sampling (Sampling Grade)

You can select one of three grades (sampling grade), STANDARD, LONG, or LO-FI, for each pad.

You can switch the sampling grade by pressing [LONG/LO-FI].

When [LONG/LO-FI] is not lit → STANDARD:

Select this when you want to sample with high-quality sound.

When [LONG/LO-FI] is lit → LONG:

Sampling time is twice that of STANDARD. Sound quality is somewhat lower.

When [LONG/LO-FI] is blinking → LO-FI:

A lo-fi sound is created, and the sampling time is greatly increased.

* *The sampling grade cannot be changed after the sample is made.*

Selecting Between Stereo and Mono Sampling

You can set whether a sample is recorded in stereo or mono for each individual pad.

When you press [STEREO], sampling is conducted in stereo when the button is lit; sampling is in mono when the button is not lit.

* *Once a sound has been sampled, it is not possible to change it from mono to stereo, or from stereo to mono.*

About Sampling Time

Available sampling time for the SP-303 (the internal memory) and memory cards are shown below.

- * *The times shown here are for mono sampling. For the internal memory only, this indicates the total time of Sample Banks A and B; with memory cards, the total time of the sixteen banks, including Sample Banks C and D, is shown.*
- * *When sampling in stereo, the available sampling time is halved.*

Internal Memory (Times Approximate)

STANDARD	LONG	LO-FI
31 seconds	63 seconds	3 minutes 10 seconds

Memory Cards (Times Approximate)

Capacity	STANDARD	LONG	LO-FI
8 MB	4 minutes	8 minutes	25 minutes
16 MB	8 minutes	16 minutes	50 minutes
32 MB	16 minutes	33 minutes	101 minutes
64 MB	33 minutes	66 minutes	202 minutes

- * *When saving data (Samples and Patterns) from the SP-303 to memory cards (p. 49, 50), then depending on the amount of data contained in the samples, available sampling time may be lower than shown above.*

If you have already sampled a sound to every pad, or if you have used up the available sampling time, you will need to first delete one or more unwanted samples, and then record your new sample to a vacant pad. (Refer to "Deleting an individual sample" on page 33.)

Sampling from a Microphone

Sample the microphone input (mono).

Here is an example describing the procedure for sampling in mono to Pad 2 in Bank B.

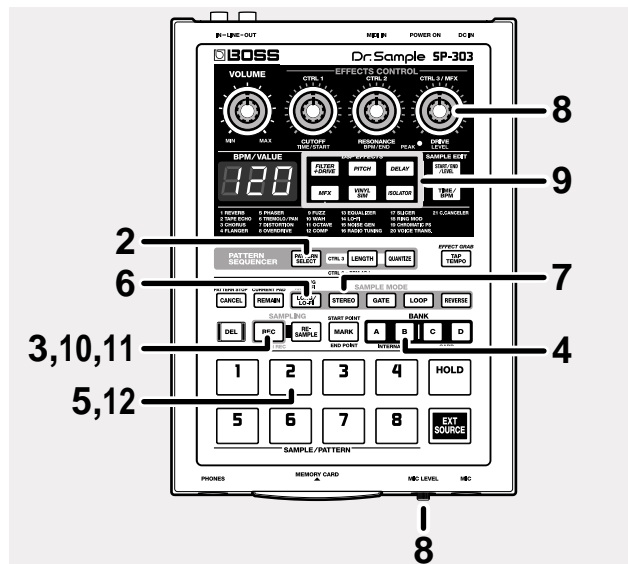

1. Refer to p. 11 for instructions on connecting the mic to the MIC jack.
2. Confirm that [PATTERN SELECT] is not lit.
If [PATTERN SELECT] is lit, press it so that the button's light goes out.
3. Press the [REC], and confirm that the button has lit.
The pads to which you can sample then blink, and the SP-303 goes into sampling standby.
** If you now decide not to sample, press [CANCEL]. [REC] light goes out.*
4. Press BANK [B], and confirm that the button has lit.
Sample Bank B is selected.
5. Press pad 2.
Pad 2 lights up, and [REC] blinks.
6. Press [LONG/LO-FI] to select the sampling grade.
[LONG/LO-FI] not lit:
STANDARD (Sampling with high-quality sound)
[LONG/LO-FI] lit:
LONG (Twice the sampling time of STANDARD)
[LONG/LO-FI] blinking:
LO-FI (Extended sampling time)
7. If [STEREO] is lit, then press [STEREO] so that the light goes out.
Mono sampling is selected.

** You can select stereo sampling with mono input. In this case, the number of voices is doubled, which also uses twice the memory.*

8. Turn the MIC LEVEL knob completely to the right (clockwise), while directing sounds into the mic, turn the CTRL 3/MFX (LEVEL) knob to adjust the sampling level so that the PEAK indicator lights only from time to time.

** Howling could be produced depending on the location of microphones relative to speakers. This can be remedied by:*

1. Changing the orientation of the microphone(s).
2. Relocating microphone(s) at a greater distance from speakers.
3. Lowering volume levels.

MEMO

If the BPM (tempo) is set prior to the beginning of sampling, then when sampling is completed, the timing at which the sound stops (the End Point) is automatically set to occur on a beat in time with the BPM value in effect when the button was pressed, and [MARK] lights up.

For more on how to set the BPM, refer to "Sampling With the Tempo Specified Beforehand" (p. 30).

For more on how to set the End Point, and on [MARK], refer to "Preventing Unneeded Portions from Being Played (Markers/Start Point/End Point)" (p. 38).

9. If you want to add effects while sampling, press the effect button at this point.

The pressed effect button lights up, and the effect is added to the sound from the mic.

** At this point, you can turn the CTRL 1 and CTRL 2 knobs to adjust the amount and quality of the effect. However, the CTRL 3 knob is used for adjusting the sampling level, and cannot be used for adjusting the effect.*

10. Press [REC].

[REC] lights up, and sampling starts.

NOTE

Never turn off the power while sampling is in progress. This may result in corruption not only of the sample currently being made, but other samples as well.

11. When you reach the point where you want sampling to stop, press [REC].

[REC] and the pad lights go out, and sampling ends.

If effects were being applied while you were sampling, the lights of effects buttons also go out.

- * You can also stop sampling without pressing [REC] by pressing the lit (sampling) pad. In this case, after sampling stops, the sound just sampled is played back automatically. The BPM is automatically calculated to correspond to the time of the sample (if BPM is set, the time from the start to the End Point), and that value appears in the display.
- * If the sampling time is two or more measures or is less than one measure, the BPM display value may be double or half the correct value. In this case, press [TIME/BPM], getting it to light up, and turn CTRL 2 (BPM) to correct this to the desired value (refer to “Changing the Sample's BPM” on p. 41).
- * Note that the displayed BPM value is an approximate value for the sampling time, and may not be entirely accurate.

12. Press the pad 2, and you will hear the sound that you just sampled.

When you want to sample to a memory card, insert a memory card into the card slot, and press BANK [C] or [D] to select the sample bank for the memory card.

If the memory card being used here has not been formatted for the SP-303, BANK [C] and [D] blink, and “FMT” appears in the display.

If you want to format at this time, press BANK [C] or [D].

BANK [C] and [D] then remain lit, and [DEL] begins to blink. When you press [DEL], formatting then begins.

Formatting the memory card erases all data on the card and allows the card to be used with the SP-303.

NOTE

The power of the SP-303 must be turned off before inserting or removing a memory card. If a memory card is inserted when the power is turned on, the data in the memory card may be destroyed, or the memory card may become unusable.

NOTE

If you select a bank or pad, or perform another operation when sampling to a memory card, the dots in the display may blink and the SP-303 may appear to stop working for a short while; however, this does not indicate a malfunction. Still, be absolutely sure never to turn off the power while the dots are blinking.

- * Depending on memory card capacity and the amount of data stored on the card, operations may stop for about a minute.

Sampling from a CD or MD

Sounds input from a CD or MD are sampled in stereo.

Here is an example describing the procedure for sampling in stereo to Pad 3 in Bank B.

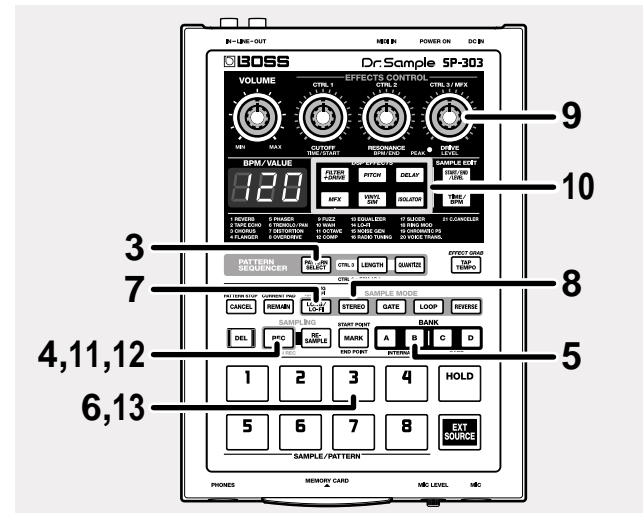

1. Refer to p. 11 for instructions on connecting the CD or MD player to the LINE IN jack.
2. Turn on the power of your CD/MD player, and put the player in play-standby mode.
3. Confirm that [PATTERN SELECT] is not lit. If [PATTERN SELECT] is lit, press it so that the button's light goes out.
4. Press [REC], and confirm that the button has lit. The pads to which you can sample then blink, and the SP-303 goes into sampling standby.
 - * If you now decide not to sample, press [CANCEL]. [REC] light goes out.
5. Press BANK [B], and confirm that the button has lit. Sample Bank B is selected.
6. Press pad 3. Pad 3 lights up, and [REC] blinks.
7. Press [LONG/LO-FI] to select the sampling grade.
 - [LONG/LO-FI] not lit: STANDARD (Sampling with high-quality sound)
 - [LONG/LO-FI] lit: LONG (Twice the sampling time of STANDARD)
 - [LONG/LO-FI] blinking: LO-FI (Extended sampling time)
8. Press [STEREO], and confirm that the button has lit. Stereo sampling is selected.

* If you select mono sampling with stereo input, the same sound is recorded to the left and right channels. In this case, the stereophonic dimension is lost, but since the number of voices is halved, the memory used is half that used in stereo; make this setting according to your usage needs.

9. Start playback of the CD or MD, turn the CTRL 3/MFX (LEVEL) knob to adjust the sampling level so that the PEAK indicator lights only from time to time.

When you finish making this adjustment, stop the CD/MD player, and put it once again in play-standby mode.

MEMO

If the BPM (tempo) is set prior to the beginning of sampling, then when sampling is completed, the timing at which the sound stops (the End Point) is automatically set to occur on a beat in time with the BPM value in effect when the button was pressed, and [MARK] lights up.

For more on how to set the BPM, refer to “Sampling With the Tempo Specified Beforehand”.

For more on how to set the End Point, and on [MARK], refer to “Preventing Unneeded Portions from Being Played (Markers/Start Point/End Point)” (p. 38).

10. If you want to add effects while sampling, press the effect button at this point.

The pressed effect button lights up, and the effect is added to the sound from the CD/MD.

* At this point, you can turn the CTRL 1 and CTRL 2 knobs to adjust the amount and quality of the effect. However, the CTRL 3 knob is used for adjusting the sampling level, and cannot be used for adjusting the effect.

11. Start playback of the CD/MD, using the timing at which you want sampling to begin, press [REC].

[REC] lights up, and sampling starts.

NOTE

Never turn off the power while sampling is in progress. Turning off the power at this point may result in corruption not only of the sample currently being made, but other samples as well.

12. When you reach the point where you want sampling to stop, press [REC].

[REC] and the pad 3 light go out and sampling ends.

If effects were being applied while you were sampling, the light of effects buttons also go out.

* You can also stop sampling without pressing [REC] by pressing the lit (sampling) pad. In this case, after sampling stops, the sound just sampled is played back automatically.

The BPM is automatically calculated according to the time of the sample (if BPM is set, the time from the Start to the End Point), and that value appears in the display.

* If the sampling time is two or more measures or is less than one measure, the BPM display value may be double or half the correct value. In this case, press [TIME/BPM], getting it to light up, and turn CTRL 2 (BPM) to correct this to the desired value (refer to “Changing the Sample's BPM” on p. 41).

* Note that the displayed BPM value is an approximate value for the sampling time, and may not be entirely accurate.

13. Press the pad 3, and you will hear the sound that you just sampled.

Sampling With the Tempo Specified Beforehand

When the BPM (tempo) is set while the SP-303 is in sampling standby mode, then when sampling is completed, the timing at which the sound stops (the End Point) is automatically set to occur on a beat in time with the BPM value in effect when the button was pressed.

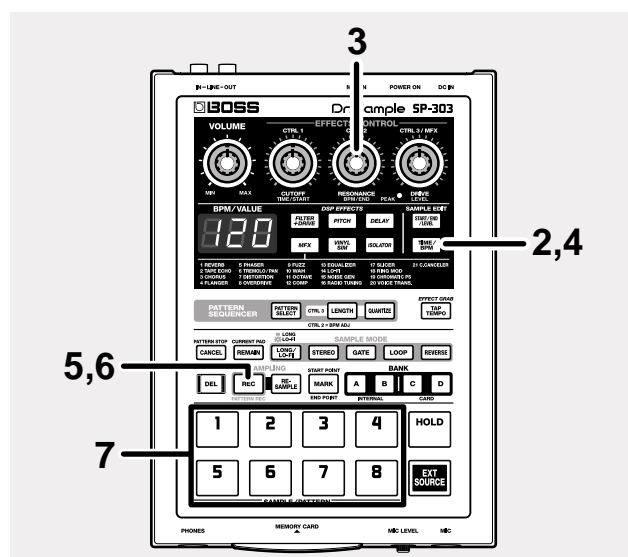

1. Refer to Steps 1–8 of “Sampling From a Microphone” or Steps 1–9 of “Sampling From a CD or MD” to prepare for sampling.

2. Press [TIME/BPM], and confirm that the button has lit.

3. Turn the CTRL 2 (BPM) knob to set the BPM.

Turning the knob to the right increases the BPM (faster tempo); turning the knob to the left decreases the BPM (slower tempo). If the knob is turned completely to the left, then “---” is displayed, and the tempo setting is cleared.

Settings range: 40–200

MEMO

At this point, you can set the BPM using [TAP TEMPO] instead of the CTRL 2 (BPM) knob. When you strike [TAP TEMPO] four times with a fixed interval, the BPM is set with quarter notes lasting the set interval, and that value then appears in the display. This is convenient when sampling from CD/MD and other sources whose tempos may not be clear.

4. Press [TIME/BPM], and confirm that the button has turned off.
5. Press [REC].
[REC] lights up, and sampling starts.
6. When you reach the point where you want sampling to stop, press [REC].
[REC] and the pad light go out and sampling ends.

* You can also stop sampling without pressing [REC] by pressing the lit (sampling) pad. In this case, after sampling stops, the sound just sampled is played back automatically.

When sampling is finished, the End Point is automatically set according to the BPM, and [MARK] lights up (refer to “Preventing Unneeded Portions from Being Played (Markers/Start Point/End Point)” on p. 38).

* If the sampling time is two or more measures or is less than one measure, the BPM display value may be double or half the correct value. In this case, press [TIME/BPM], getting it to light up, and turn CTRL 2 (BPM) to correct this to the desired value (refer to “Changing the Sample's BPM” on p. 41).

* Note that the displayed BPM value is an approximate value for the sampling time, and may not be entirely accurate.

* Depending on the BPM value, the timing as corresponds with the BPM may not precisely match the time between the Start Point and the End Point. This may result in a growing discrepancy in timing if the sample is continuously played back over an extended period in Loop Playback (p. 36).

7. When the pad to which the sample was made is pressed, the current sample is then played back.

Starting Sampling Automatically (Auto Sampling)

The SP-303 provides an Auto Sampling feature which automatically begins sampling when the input sound (signal) exceeds a specified level. This is convenient when you wish to begin sampling from the introduction of a song.

If you make the following settings to specify the sampling start level, sampling will begin automatically when the input exceeds the specified level.

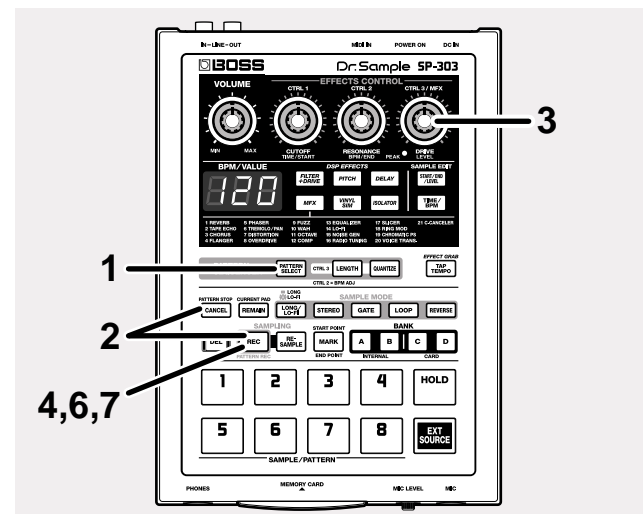

1. Confirm that [PATTERN SELECT] is not lit.
If [PATTERN SELECT] is lit, press it so that the button's light goes out.
2. While holding down [CANCEL], press [REC].
[REC] blinks, and “-0-” appears in the display.
3. Turn the CTRL 3/MFX (LEVEL) knob to set the level.
The level at which the PEAK indicator lights will be the sampling start level. Rotating the knob toward the right will raise the level. Here, the level setting (indicated in nine steps, 0–8) is displayed.
Example of Display: -3-
* Normal sampling (not Auto Sampling) is in effect when “-0-” is displayed.
* Now, with Auto Sampling stopped, press [CANCEL].
[REC] light goes out.
4. Press [REC] to set the sampling start level.
[REC] light goes out.
5. Refer to Steps 1–8 of “Sampling from a microphone” or Steps 1–9 of “Sampling from a CD or MD” to prepare for sampling.

6. Press [REC].

[REC] will light, and the SP-303 will wait for an input signal. “rdY” (ready) appears in the display.

When the input from the LINE IN or MIC rises above the sampling start level, sampling will start.

When sampling begins, the display changes to “rEC.”

NOTE

Never turn off the power while sampling is in progress. Turning off the power at this point may result in corruption not only of the sample currently being made, but other samples as well.

7. When you wish to stop sampling, press the [REC] button.

[REC] and the pad lights go out and sampling ends.

To stop auto sampling

If you wish to stop auto sampling, use the following procedure.

1. Confirm that [PATTERN SELECT] is not lit.

If [PATTERN SELECT] is lit, press it so that the button's light goes out.

2. While holding down [CANCEL], press [REC].

[REC] will blink.

3. Turn the CTRL 3/MFX (LEVEL) knob all the way to the left until “-0-” appears in the display.

4. Press [REC].

[REC] light goes out.

Making Samples with Effects Added (Resampling)

With the SP-303, you can play back a sample that has effects added to it, and then sample that sound, which is then handled as a new sample. This process is called “resampling.”

Here is an example describing the procedure for resampling Pad 1 in BANK A with the Filter + Overdrive added, and storing this to Pad 4 in Bank B.

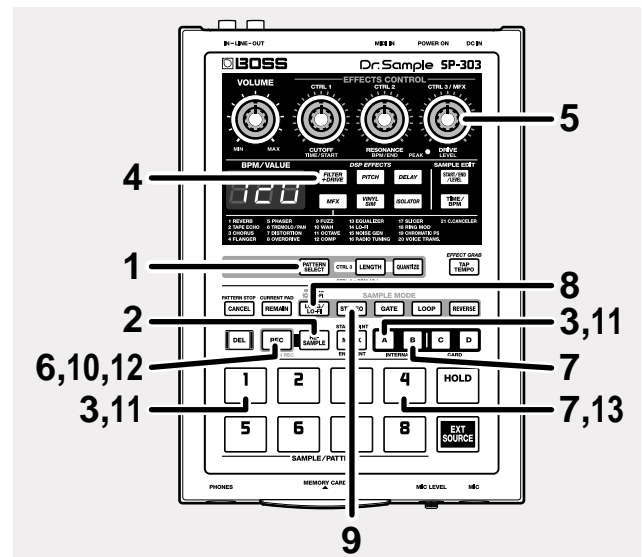

1. Confirm that [PATTERN SELECT] is not lit.

If [PATTERN SELECT] is lit, press it so that the button's light goes out.

2. Press [RESAMPLE], and confirm that the button has lit. “LEV” appears in the display.

3. Select a pad to which a sample has already been assigned to use as the resampling source.

Here, select Pad 1 in Bank A.

Press BANK [A], illuminating the button, then press Pad 1. Pad 1 lights up, and the sample assigned to Pad 1 is played.

4. Press [FILTER+DRIVE], and confirm that the button has lit.

The Filter + Overdrive is turned on, and the effect is applied to the sound from Pad 1 in Bank A.

Adjust the effect as needed by turning the CTRL 1 and CTRL 2 knobs.

* You cannot change the sound of the effect with the CTRL 3/MFX knob when [RESAMPLE] is lit. If you want to use the CTRL 3/MFX knob to change the sound of the effect, press [CANCEL]; the [RESAMPLE] light then goes off.

5. Turn the CTRL 3/MFX (LEVEL) knob to adjust the sampling level so that the PEAK indicator lights only from time to time.
 6. Press [REC], and confirm that the button is blinking.
The bank buttons and pads that are available for holding samples then blink.
 7. Select the bank and pad to which the sample after resampling is to be assigned.
Here, select Pad 4 in Bank B.
Press BANK [B], and confirm that the button has lit, then press Pad 4.
The Pad 4 will light.
* You cannot resample to the same pad as the source sample's.
 8. Press [LONG/LO-FI] to select the sampling grade.
[LONG/LO-FI] not lit:
STANDARD (Sampling with high-quality sound)
[LONG/LO-FI] lit:
LONG (Twice the sampling time of STANDARD)
[LONG/LO-FI] blinking:
LO-FI (Extended sampling time)
 9. Press [STEREO] to select either stereo or mono sampling.
[STEREO] lit: Stereo sampling
[STEREO] not lit: Mono sampling
 10. Press [REC], and confirm that the button has lit.
* Resampling does not yet start at this point.
 11. Press the pad to which the source sample has been assigned.
Press BANK [A], and confirm that the button has lit, then press Pad 1.
The sample assigned to Pad 1 begins playing, while resampling starts simultaneously.
- NOTE**
Never turn off the power while resampling is in progress. Turning off the power here may result in corruption not only of the sample currently being made, but other samples as well.
12. When you reach the point where you want sampling to stop, press [REC].
[REC], pad, and the effect button lights go out and resampling ends.
BANK [A] light goes out, and BANK [B] lights up.
 13. When you press Pad 4, the sound that was just resampled is played back.

Deleting an Individual Sample

To delete only a single sample, use the following procedure.

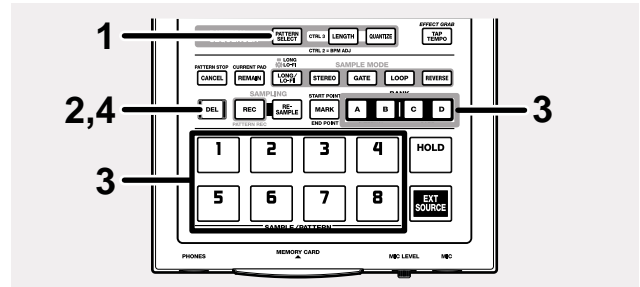

1. Confirm that [PATTERN SELECT] is not lit.
If [PATTERN SELECT] is lit, press it so that the button's light goes out.
2. Press [DEL], and confirm that the button has lit.
"dEL" appears in the display, and the pads to which samples are assigned begin to blink.
* If there are no samples assigned to any of the pads, "EMP" appears in the display for several seconds, and you cannot proceed with the deletion.
3. Press the bank button and pad for the sample you want to delete.
The selected pad lights up, and [DEL] blinks again.
* If you press a pad to which no sample is assigned, nothing will happen.
* If you decide not to delete, press [CANCEL].
4. Press [DEL].
[DEL] lights up, and the dots in the display blink.
During the deletion process, all Pads from [1] through [8] will at first light up, then go out one by one (starting with [1]), indicating the progress of the deletion.
The deletion is completed when the dots stop blinking and remain off.
* Note that the deletion process may take up to approximately one minute or longer to complete.

NOTE

Never turn off the power while the dots are blinking in the display. Turning off the power at this point may result in corruption of data not only in the sample that was being deleted, but in other samples as well.

Deleting All Samples Together

You can delete all samples from the SP-303's internal memory or memory card in one operation.

- * *When this procedure is carried out on a memory card, the memory card's backup area (refer to p. 48) is deleted at the same time. So, please check the data carefully before deleting.*

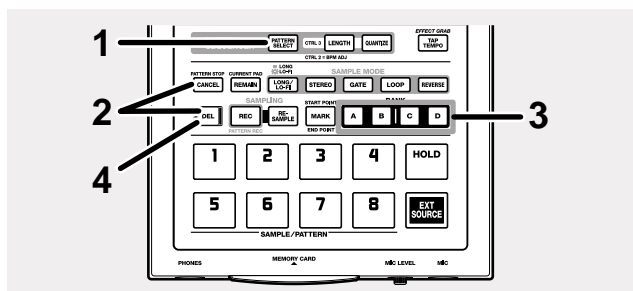

1. **Confirm that [PATTERN SELECT] is not lit.**
If [PATTERN SELECT] is lit, press it so that the button's light goes out.
2. **Hold down [CANCEL] and press [DEL].**
"dAL" (Delete ALL) appears in the display.
[DEL] lights up, and the bank buttons blink.
3. **Press the BANK button to select the memory to be cleared.**
The selected memory bank lights up, and [DEL] blinks.
If deleting the samples in the internal memory, press BANK [A] or [B]; if deleting the samples on a memory card, press BANK [C] or [D].
When BANK [A] or [B] is pressed, both [A] and [B] light up.
When BANK [C] or [D] is pressed, both [C] and [D] light up.
* *If no memory card is inserted, then pressing BANK [C] or [D] creates no response.*
* *If you decide not to delete, press the [CANCEL] button.*
4. **Press [DEL].**
[DEL] lights up, and the dots in the display blink.
During the deletion process, all Pads from [1] through [8] will at first light up, then go out one by one (starting with [1]), indicating the progress of the deletion.
The deletion is completed when the dots stop blinking and remain off.
* *Note that the deletion process may take up to approximately one minute or longer to complete.*



Never turn off the power while the dots on the display are blinking. Turning off the power at this point may result in corruption of data not only in the sample that was being deleted, but in other samples as well.

Changing the Assignment of Samples to the Pads

You can change the assignment of samples to the pads by exchanging the samples of two pads.

You can also switch between a pad to which a sample has already been assigned and a pad to which no pattern has been assigned.

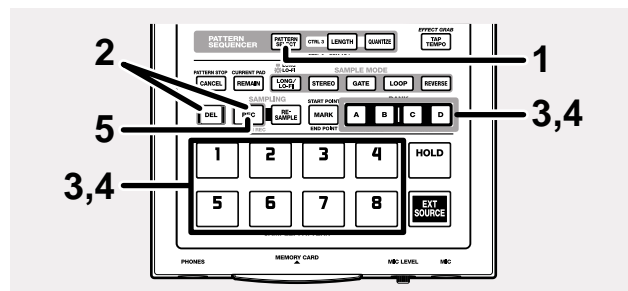

1. **Confirm that [PATTERN SELECT] is not lit.**
If [PATTERN SELECT] is lit, press it so that the button's light goes out.
2. **While holding down [DEL], press [REC].**
"CHG" appears in the display, and [DEL] and [REC] light up.
The pads to which the samples are assigned then blink.
3. **Press the BANK button and the pad for one of the samples to be exchanged.**
The pad that is pressed remains lit.
4. **Press the BANK button and the pad for the other sample to be exchanged.**
The pad that is pressed remains lit, and [REC] blinks.
Lights for pads other than the two selected go out.
* *To cancel the exchange, press [CANCEL].*
5. **Press [REC].**
[DEL] and [REC] light, and the dots in the display blink.
During the exchange process, all Pads from [1] through [8] will at first light up, then go out one by one (starting with [1]), indicating the progress of the exchange.
The exchange is completed when the dots stop blinking and remain off.
* *Note that the exchange process may take up to approximately one minute or longer to complete.*
* *If insufficient free space is available when exchanging samples between the SP-303's memory and a memory card, "FuL" is displayed, and the exchange cannot be carried out. Note that sufficient memory is needed particularly on the memory card.*

NOTE

Never turn off the power while the dots on the display are blinking. Turning off the power at this point may result in corruption of data not only in the sample that was being deleted, but in other samples as well.

Checking the Remaining Sampling Time

To check the remaining available sampling time, do the following.

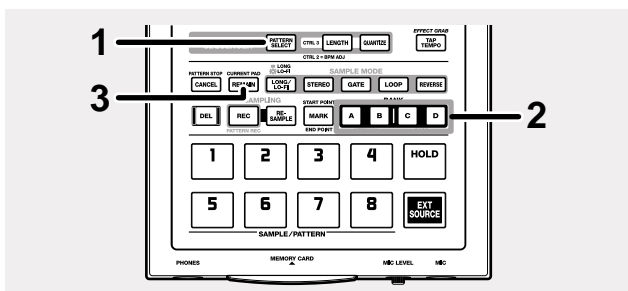

1. Confirm that [PATTERN SELECT] is not lit.

If [PATTERN SELECT] is lit, press it so that the button's light goes out.

2. Select the memory whose remaining time you want to check.

If checking the remaining time of the internal memory, press either BANK [A] or [B], causing the button to light up.

If checking the remaining time of a memory card, press BANK [C] or [D], causing the button to light up.

* *The same action is performed, regardless of whether BANK [A] or [B] (or BANK [C] or [D]) is pressed.*

3. Press [REMAIN].

The remaining sampling times for "STANDARD" and "MONO" are indicated in the display.



* *Please be aware that the displayed remaining time may not be precisely accurate.*

* *When displaying the remaining sampling time of a memory card, the indication of minutes and seconds changes according to the amount of time left. If there are ten minutes or more remaining, then the time is indicated only down to the tens of seconds.*



Additionally, when one hundred minutes or more of sampling time remains, seconds are not shown, and only the "minutes" are indicated.

Chapter 4. Changing the Sampling Settings

NOTE

When changing the sampling settings for a memory card, the changes may take some time to complete, and it may appear that operation has stopped momentarily. Please be aware of this fact beforehand.

Playing Phrases Repeatedly (Loop Playback)/ Playing the Sound Only Once (One Shot Playback)

If you have sampled a phrase of several measures and wish to play it back repeatedly, use Loop Playback.

For sounds (such as drums) that you want to playback only once when you press the pad, use One Shot Playback.

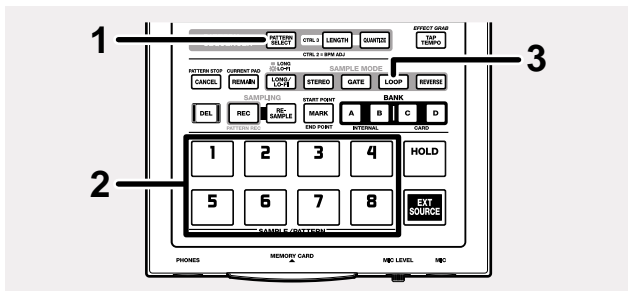

1. **Confirm that [PATTERN SELECT] is not lit.**
If [PATTERN SELECT] is lit, press it so that the button's light goes out.
2. **Press the pad to which the sample whose Loop or One Shot setting you want to make is assigned.**
The pad will light, and the sample will sound. This pad becomes the current pad.
3. **Press [LOOP], and confirm that the button has turned on or off.**
[LOOP] lit: Loop Playback
[LOOP] not lit: One Shot Playback

Having Samples Play Only While the Pad Is Pressed (Gate Playback)

Having Samples Play Even If the Pad Is Not Held Down (Trigger Playback)

If you select Gate Playback, the sample will play when you press the pad, and will stop when you release the pad. i.e., the sample will play only while the pad is being pressed.

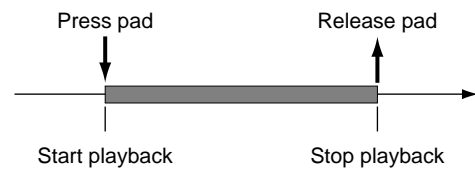

In Trigger Playback, the sound is played when you press the pad and then continues even after you release the pad.

The next time you press a pad, operation changes according to the One Shot or Loop Playback settings.

When set to One Shot Playback ([LOOP] not lit):

Sound is played from the beginning of the sample again.

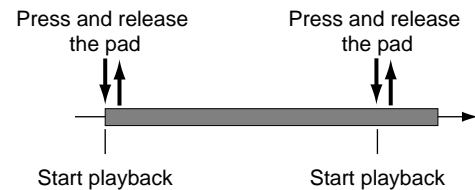

When set to Loop Playback ([LOOP] lit):

The sound stops.

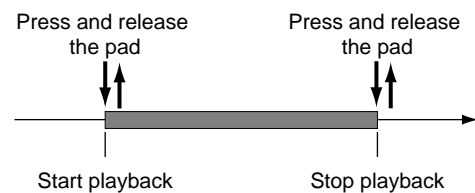

Use Trigger Playback with Loop Playback when you wish to continue playing long phrases or looped phrases. You will also use Trigger Playback with One Shot Playback to play samples such as drums, so that the sample will be played all the way to the end even if the pad is pressed for a brief moment.

- * After a sample is recorded, Trigger Playback will be selected automatically.
- * Sounds may fail to stop playing in lengthy samples for which the Trigger Playback with One Shot Playback setting is used. To stop sounds from playing, temporarily change the playback setting to Loop Playback, then press the pad.

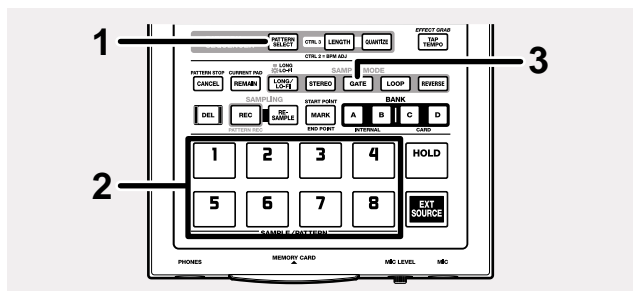

1. **Confirm that [PATTERN SELECT] is not lit.**
If [PATTERN SELECT] is lit, press it so that the button's light goes out.
2. **Press the pad to which the sample whose Gate or Trigger setting you want to make is assigned.**
The pad will light, and the sample will sound. This pad becomes the current pad.
3. **Press [GATE], and confirm that the button has turned on or off.**

[GATE] lit: Gate Playback
[GATE] not lit: Trigger Playback

* If [LOOP] is not lit, then when the sample is played back to the end, then playback stops automatically, even if the pad is held down, and the pad light goes out.

Playing Samples in the Reverse Direction (Reverse Playback)

Reverse Playback plays samples backwards from the end of the sample, providing an effect like that of a tape being rewound.

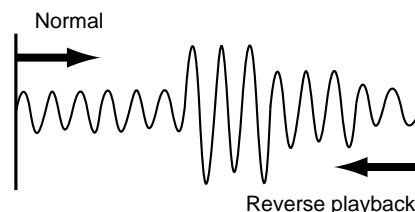

* *Time Modify (p. 42) and Reverse Playback cannot be selected at the same time. Time Modify settings are disregarded during Reverse Playback.*

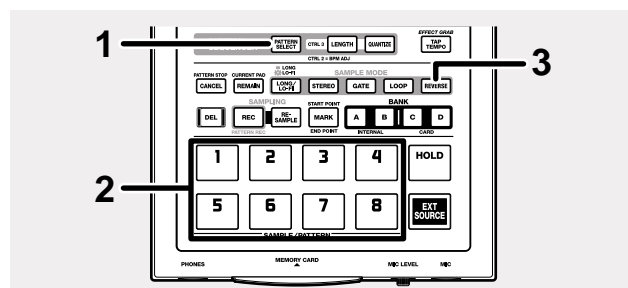

1. **Confirm that [PATTERN SELECT] is not lit.**
If [PATTERN SELECT] is lit, press it so that the button's light goes out.
 2. **Press the pad which contains the sample that you wish to playback in reverse.**
The pad will light, and the sample will sound. This pad becomes the current pad.
 3. **Press [REVERSE], and confirm that the button has lit.**
[REVERSE] lit: Reverse Playback
- * *Pressing [REVERSE] toggles between Reverse Playback and normal playback ([REVERSE] is not lit).*
- * *When Reverse Playback is selected, the Start and End Points (p. 38) are reversed.*

Setting the Sample Volume

With the SP-303, you can set the volume level for each sample individually.

This is convenient for balancing the volume levels of samples on different pads.

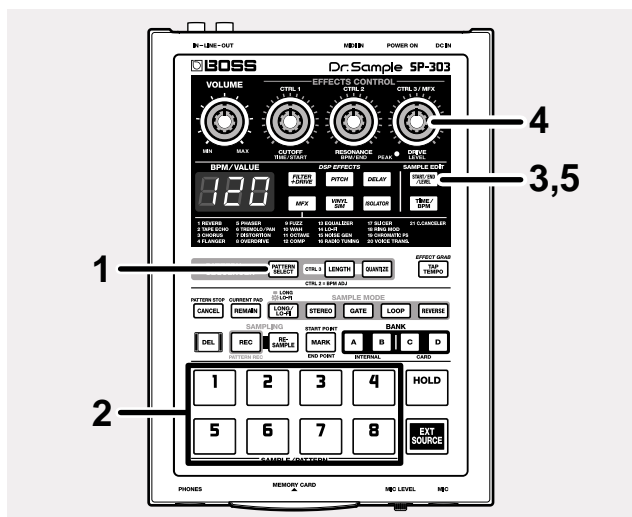

1. Confirm that [PATTERN SELECT] is not lit.
If [PATTERN SELECT] is lit, press it so that the button's light goes out.
2. Press the pad to which the sample whose volume you want to adjust is assigned.
The pad will light, and the sample will sound. This pad becomes the current pad.
3. Press [START/END/LEVEL], and confirm that the button has lit.
4. Turn the CTRL 3/MFX (LEVEL) knob to adjust the sample's volume.
Turning the knob to the right increases the volume; turning the knob to the left decreases the volume. The volume is set to maximum when the value 127 is selected using the knob. This is equivalent to the volume of the sound directly sampled.
5. Press [START/END/LEVEL], and confirm that the button has turned off.

* When [START/END/LEVEL] is lit, you can then use the CTRL 1 and 2 knobs to change not only the volume, but the Start Point and End Point as well. If you inadvertently move the CTRL 1 or CTRL 2 knob, return the CTRL 1 and 2 knobs to the center position. This restores the settings in effect before the knobs were moved. If you press [START/END/LEVEL], causing the button light to go out, without returning the knobs to the center position, the changed settings are recorded and stored.

Preventing Unneeded Portions from Being Played (Markers/Start Point/End Point)

On the SP-303, the area of the waveform data which will actually playback can be specified/memorized independently for each sample.

The point at which the waveform data will begin playing is called the **Start Point**, and the point at which it will stop playing is called the **End Point**.

If the sound you sampled contains unwanted material at the beginning, adjust the Start Point so that the unwanted portion is not heard. If the unwanted material is at the end, adjust the End Point. In this way, you can make only the desired portion playback.

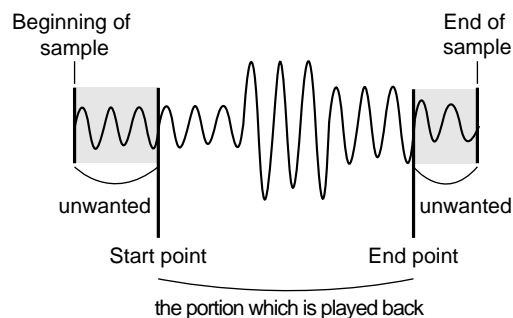

* When you modify the Start Point or End Point settings, the BPM will be calculated according to the newly specified time, and displayed. If the sampling time is two or more measures or is less than one measure, the BPM display value may be double or half the correct value. In this case, carry out the procedure in "Changing the Sample's BPM" (p. 41) to reset this to the desired value.

Also, please be aware that in some cases (such as triple meter), it may not be possible to calculate or adjust the BPM value accurately.

Adjusting both the Start and End points

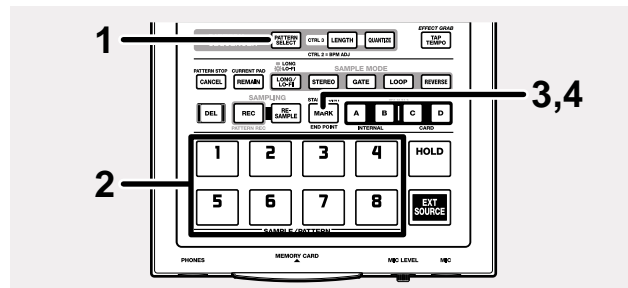

1. Confirm that [PATTERN SELECT] is not lit.
If [PATTERN SELECT] is lit, press it so that the button's light goes out.

2. Press the pad to which the sample you want to change is assigned.

The pad will light, and the sample will sound. This pad becomes the current pad.

* For gate playback, continue pressing the pad.

3. At the location where you wish to set the Start Point, press [MARK].

[MARK] blinks, and “---” appears in the display.

MEMO

If you now set the BPM (tempo), the End Point will automatically be adjusted to the location of the beat closest to the timing (i.e., an interval of beats measured from the Start Point according to the BPM value) which set when you press [MARK] at Step 4.

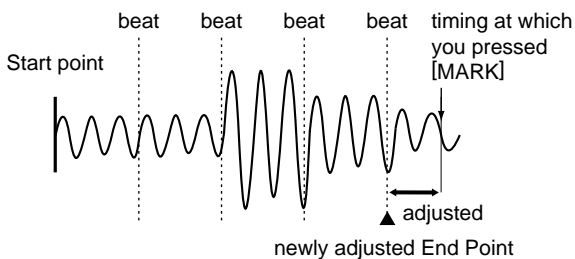

* To set the BPM, press [TIME/BPM], causing the button to light, then either turn the CTRL 2 knob or press [TAP TEMPO] four or more times.

4. At the location where you wish to set the End Point, press [MARK] once again.

When [MARK] lights, the setting is complete.

* If the setting was not made as desired, press the lit [MARK] button while the sound is still playing to make it go dark, and re-do the procedure from step 1.

Adjusting only the End Point

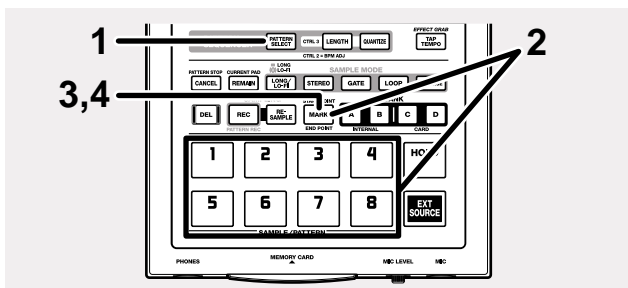

1. Confirm that [PATTERN SELECT] is not lit.
If [PATTERN SELECT] is lit, press it so that the button's light goes out.

2. Hold down [MARK] and press the pad to which the sample you wish to change is assigned.

The pad will light, and the sample will sound. This pad becomes the current pad.

* For gate playback, continue pressing the pad.

3. Release your finger from [MARK].

[MARK] blinks, and “---” appears in the display.

MEMO

If you now set the BPM (tempo), the End Point will automatically be adjusted to the location of the beat closest to the timing (i.e., an interval of beats measured from the Start Point according to the BPM value) which set when you press [MARK] at Step 4.

* To set the BPM, press [TIME/BPM], causing the button to light, then either turn the CTRL 2 knob or press [TAP TEMPO] four or more times.

4. At the location where you wish to set the End Point, press [MARK].

When [MARK] lights, the setting is complete.

* If the setting was not made as desired, press the lit [MARK] button while the sound is still playing to make it go dark, and re-do the procedure from step 1.

Adjusting only the Start Point (End Point is the end of the sample)

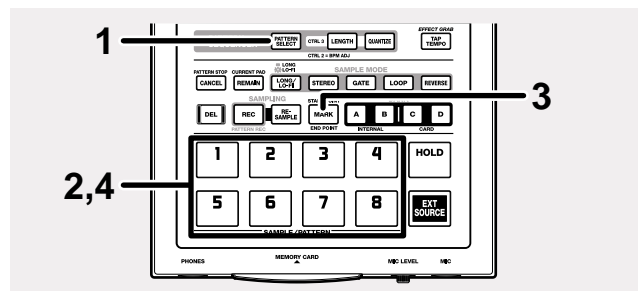

1. Confirm that [PATTERN SELECT] is not lit.
If [PATTERN SELECT] is lit, press it so that the button's light goes out.
2. Press the pad to which the sample you want to change is assigned.
The pad will light, and the sample will sound. This pad becomes the current pad.
* For gate playback, continue pressing the pad.
3. At the location where you wish to set the Start Point, press [MARK].
[MARK] will blink.

Chapter 4. Changing the Sampling Settings

- Press the pad again (or in the case of Gate playback, release the pad).

When [MARK] lights, the setting is complete.

- * If the setting was not made as desired, press the lit [MARK] button while the sound is still playing to make it go dark, and re-do the procedure from step 1.

Finely Adjusting the Start Point and End Point

To make fine adjustments to the Start Point and End Point, use the following procedure.

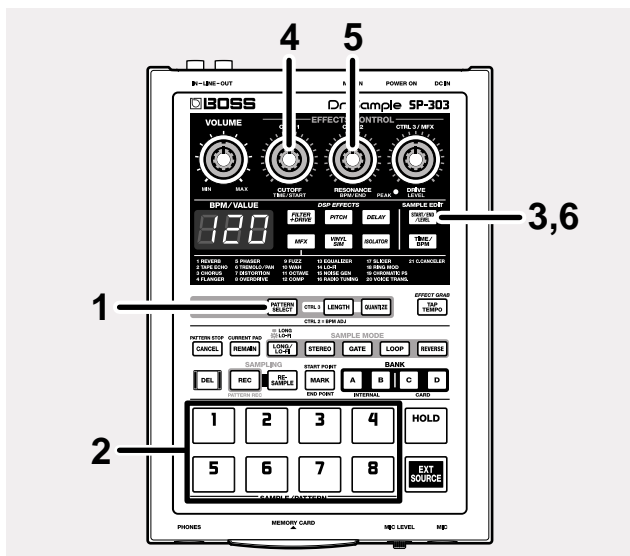

- Confirm that [PATTERN SELECT] is not lit.
If [PATTERN SELECT] is lit, press it so that the button's light goes out.
- Press the pad to which the sample you want to change is assigned.
The pad will light, and the sample will sound. This pad becomes the current pad.
- Press [START/END/LEVEL], and confirm that the button has lit.
- Turn the CTRL 1 (START) knob.
The center position sets the current Start Point; turn the knob to the left to move the Start Point to an earlier point, or to the right to move the Start Point to a later point.
 - * If the Start Point is set at the beginning of the sample, then the Start Point will not move to an earlier point, even when the knob is turned to the left.
 - * You cannot set the Start Point and End Point within 100 milliseconds of each other.

- * If you want to cancel the move, return the CTRL 1 (START) knob to the center position, setting it so that "0" is displayed.

- Turn the CTRL 2 (END) knob.

The center position sets the current End Point; turn the knob to the left to move the End Point to an earlier point, or to the right to move the End Point to a later point.

- * If the End Point is set at the very end of the sample, then the End Point will not move to a later point, even when the knob is turned to the right.
- * You cannot set the Start Point and End Point within 100 milliseconds of each other.
- * If you want to cancel the move, return the CTRL 2 (END) knob to the center position, setting it so that "0" is displayed.

- Press [START/END/LEVEL], and confirm that the button has turned off.

The Start Point and End Point settings are recorded.

- * You can move the Start Point and End Point in a single operation up to a total time of roughly 130 milliseconds. If you want to move beyond this range, you will merely need to repeat Steps 3–6.
- * If the resulting Start Point and End Point become the start and end of the sample, the [MARK] light goes out.
- * If the [MARK] light is off for a sample, when the Start Point or End Point is moved, [MARK] then lights up.
- * When the Start Point or End Point is changed, the sample's BPM (tempo) then also changes automatically. However, values to the right of the dot are rounded off, which results in a slight inaccuracy in timing.

Deleting Unwanted Portions (Truncate)

When you specify the Start/End Points, unused portions of waveform data will occur. By deleting (Truncating) these portions, you can make more efficient use of memory.

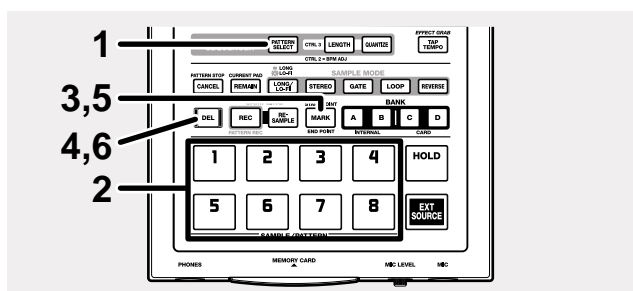
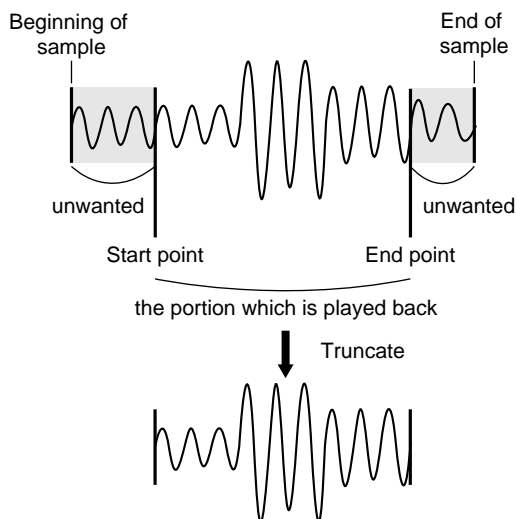

1. Confirm that [PATTERN SELECT] is not lit.
If [PATTERN SELECT] is lit, press it so that the button's light goes out.
2. Press the pad to which the sample whose Truncate you want to make is assigned.
The pad will light, and the sample will sound. This pad becomes the current pad.
3. Make sure that the Start and End Points have been set ([MARK] is lit).
4. Press [DEL], and confirm that the button has lit.
Although the pad also blinks at this time, do not press the pad.
5. Press [MARK].
[DEL] blinks, and "trC" appears in the display.

6. Press [DEL].
[DEL] will light, and the dots in the display blink.
During the truncation process, all Pads from [1] through [8] will at first light up, then go out one by one (starting with [1]), indicating the progress of the truncation.
The truncation is completed when the dots stop blinking and remain off.
** Note that the truncation process may take up to approximately one minute to complete.*

NOTE

Never turn off the power while the dots are blinking. This may result in corruption not only of the sample currently being truncated, but may also damage other samples as well as the memory card.

Changing the Sample's BPM

The BPM (tempo) of a sample is determined automatically according to the length of the interval between the Start Point and End Point. Depending on the sampling time, the calculated BPM value may be half or double the correct BPM. In this case, use the following procedure to adjust the BPM.

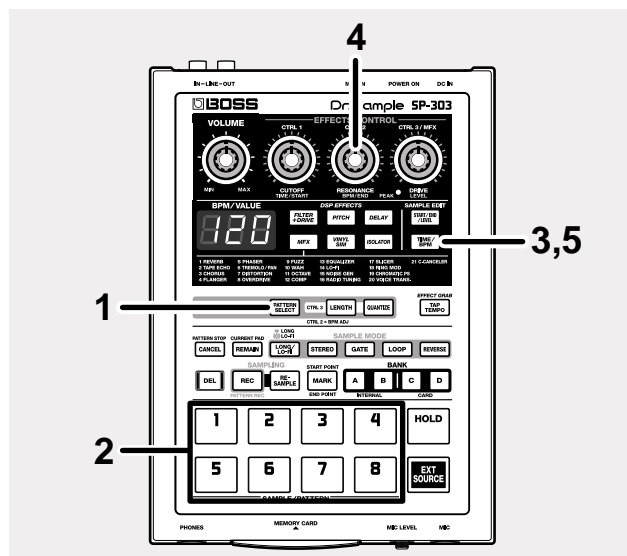

1. Confirm that [PATTERN SELECT] is not lit.
If [PATTERN SELECT] is lit, press it so that the button's light goes out.
2. Press the pad to which the sample you want to change is assigned.
The pad will light, and the sample will sound. This pad becomes the current pad.
3. Press [TIME/BPM], and confirm that the button has lit.

4. Turn the CTRL 2 (BPM) knob to change the BPM value.

If you want to halve the displayed value, turn the knob to the left; turn the knob to the right if you want to double the value.

5. Press [TIME/BPM] again.

The [TIME/BPM] light goes out, and the BPM setting is recorded.

- * Note that when [TIME/BPM] is lit, the CTRL 1 (TIME) knob then changes not only the BPM, but the sample playback time as well.

Changing the Length of a Sample Without Changing the Pitch (Time Modify)

If you wish to consecutively playback samples which have the same key (pitch) but a different tempo, you can use the Time Modify function so that the natural tempo will be preserved.

- * When Reverse Playback (p. 37) is selected, the Time Modify settings are disregarded, and the effect is disabled. When you want to use Time Modify, turn Reverse Playback off.

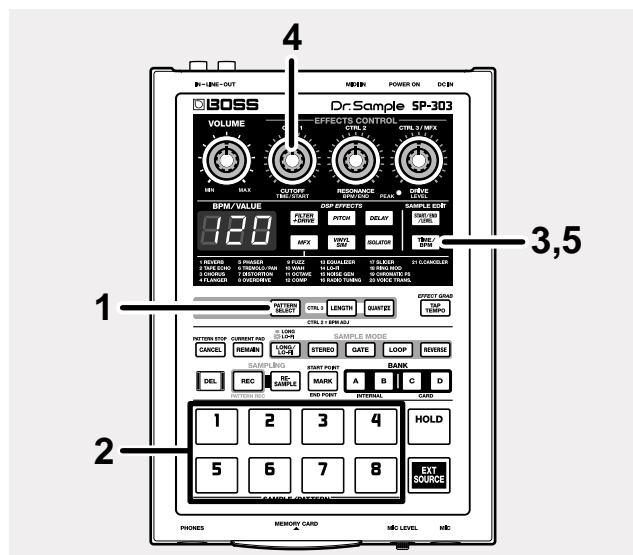

1. Confirm that [PATTERN SELECT] is not lit.

If [PATTERN SELECT] is lit, press it so that the button's light goes out.

2. Press the pad to which the sample you want to change is assigned.

The pad will light, and the sample will sound. This pad becomes the current pad.

3. Press [TIME/BPM], and confirm that the button has lit.

4. Turn the CTRL 1 (TIME) knob.

The BPM value appearing in the display changes as the length of the sample is changed.

Turn the knob to the left to increase the length, slowing down the tempo. Turn the knob to the right to shorten the sample, which increases the tempo.

When the knob is turned completely to the left, Time Modify is turned off, and the samples are played at the original length. ("oFF" appears in the display.)

When the knob is turned completely to the right, samples are played at the tempo set in the pattern. ("Ptn" appears in the display.)

- * The BPM can be changed over a range from one-half to approximately 1.3 times a sample's original BPM. However, the BPM cannot be set outside the range of 40–200.
- * When Time Modify is set to Ptn, the sample's tempo changes according to the pattern tempo only when the pattern tempo is set in a range from one-half to 1.3 times the sample's original BPM. When the pattern tempo setting is outside this range, the sample's tempo is restricted to the value for the upper limit (200) or lower limit (40).

5. Press [TIME/BPM] again.

The [TIME/BPM] light goes out, and the value setting is recorded.

- * Note that when Time Modify is used with a sample, a rapid tremor or noise may become audible in the sound.

Chapter 5. Recording Sample Performances (Pattern Sequencer)

By recording the processes of playing samples as patterns, you can then play back those samples in the same way later on.

This is convenient for creating songs by combining a number of sampled phrases and making rhythm patterns from combinations of sampled rhythms.

Composition of Patterns

When [PATTERN SELECT] is lit, you can assign one pattern to each of the Pads 1–8 on the panel. A set of eight patterns assigned to the pads is collectively referred to as a “**pattern bank**,” and the SP-303 has four pattern banks, A–D, for your use. Pattern Banks A and B are the SP-303’s own internal banks, and Pattern Banks C and D are banks stored on memory cards.

* *Pattern Bank A is selected when the power is turned on.*

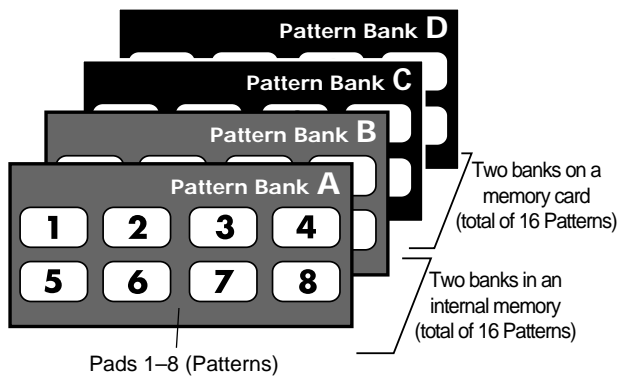

When [PATTERN SELECT] is lit, BANKs [A]–[D] are used as pattern banks, with Pads 1–8 used to specify particular patterns.

Changing the Tempo of a Pattern

The pattern tempo setting is applied to all patterns.

* *You cannot save different tempo settings for individual patterns.*

When changing the tempo, use the following procedure.

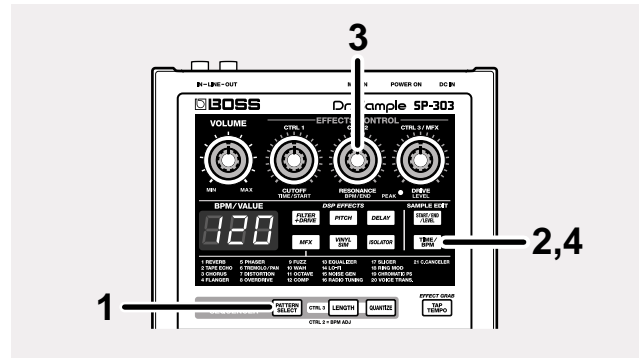

1. Press [PATTERN SELECT], and confirm that the button has lit.
“Ptn” appears in the display.
* *If already lit, there is no need to press the button.*
2. Press [TIME/BPM], and confirm that the button has lit.
The tempo (BPM) of a pattern appears in the display.
* *When the pattern tempo is synchronized to the tempo of a MIDI sequencer (p. 55), “---” appears in the display, and you will not be able to carry out any other operations.*
3. Turn the CTRL 2 (BPM) knob to change the BPM value.
The selected BPM appears in the display.
Turn the knob to the left to increase the BPM (speed up the tempo). Turn the knob to the right to decrease the BPM (slow down the tempo).
Settings range: 40–200
When the BPM is set from 40 to 60 or from 160 to 180, then you can select only even-numbered values.
When the BPM is set from 180 to 200, then you can set either 180, 183, 186, 190, 193, 196, or 200.
4. Press [TIME/BPM], and confirm that the button has turned off.
The set BPM is recorded.

To Synchronize with a CD’s or Turntable’s Tempo

You can set a pattern’s tempo to that of a CD or turntable performance by pressing [TAP TEMPO] in time with the performance.

When you strike [TAP TEMPO] four times using a fixed, steady timing, the BPM is set with quarter notes of that interval, and that value then appears in the display.



[TAP TEMPO] can be used when [PATTERN SELECT] is lit.

Stopping Patterns

Once playback begins, the pattern continues playing even after you release the pad.

If you want to stop a pattern during playback, press [CANCEL] (PATTERN STOP).

MEMO

When [PATTERN SELECT] is lit and “Ptn” appears in the display, you can press the lit pad (the pad for the pattern currently being played back) to stop playback of the pattern.

Switching Patterns While Playback Is in Progress

During playback of a pattern, you can switch to a different pattern in real time.

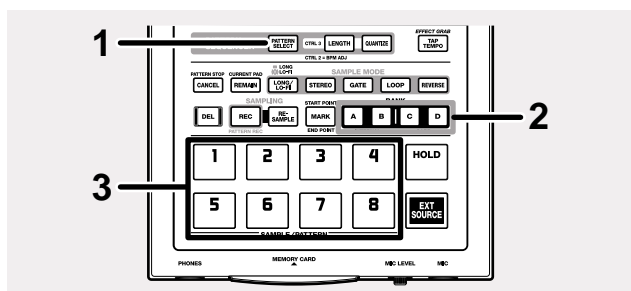

1. Press [PATTERN SELECT], and confirm that the button has lit.
“Ptn” appears in the display.
2. Press any of BANK [A]–[D], causing that button to light up, to select the bank containing the pattern to which you want to switch.
* You cannot select Pattern Bank C or D if there is no memory card inserted.
3. Press the pad for the pattern to which you want to switch.
The pattern currently being played back stops, and playback of the new pattern immediately begins. At this time, the [PATTERN SELECT] light goes out.

* No action results if you press a pad to which no pattern is assigned (no pattern is recorded).

Recording the Pattern

When recording patterns of sample performances, until the recording is stopped, you can repeat recording of a specified number of measures (Loop Recording), thus allowing you to layer a sequence of sample performances over the same section (Overdubbing).

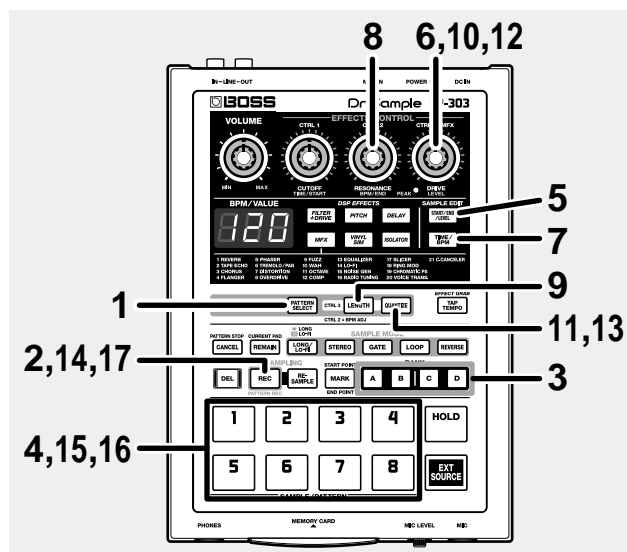

1. Press [PATTERN SELECT], and confirm that the button has lit.
“Ptn” appears in the display. The pad to which the pattern is assigned blinks.
* If already lit, there is no need to press the button.
* Take care to note that if [PATTERN SELECT] is not lit, the SP-303 will then proceed with sampling.
2. Press [REC], and confirm that the button has lit.
All pads not assigned to the pattern blink, and the metronome sound starts.
3. Press any of BANK [A]–[D] to select the bank containing the pattern you want to record.
* You cannot select Pattern Bank C or D if there is no memory card inserted.
4. Press the pad to which the pattern you want to record is assigned.
The pressed pad lights up, and the lights for the other pads go out. [REC] blinks.
5. Press [START/END/LEVEL], and confirm that the button has lit.
6. Turn the CTRL 3/MFX (LEVEL) knob to adjust the metronome volume.

7. Press [TIME/BPM], and confirm that the button has lit.
The tempo (BPM) of a pattern appears in the display.
8. **While listening to the metronome, turn the CTRL 2 (BPM) knob to adjust the pattern's tempo.**
Settings range: 40–200
When the BPM is set from 40 to 60 or from 160 to 180, then you can select only even-numbered values.
When the BPM is set from 180 to 200, then you can set either 180, 183, 186, 190, 193, 196, or 200.
** You can also set the tempo by pressing [TAP TEMPO] four or more times. When using [TAP TEMPO] to select the tempo, you can set the BPM to any value in a range from 40 to 200.*
9. Press [LENGTH], and confirm that the button has lit.
The length of the pattern being recorded (pattern length), is indicated in the display as a number of measures.
10. **Turn the CTRL 3/MFX knob to adjust the pattern length.**
The pattern length value for the pattern being set appears in the display.
Settings range: 1–99
You can set patterns of one to twenty measures in one-measure units; longer patterns can be set in four-measure units.
11. Press [QUANTIZE], and confirm that the button has lit.
[LENGTH] light goes out.
The quantize setting value appears in the display.

What is Quantize?

When pressing the pads to play samples, a certain amount of discrepancy in the timing is unavoidable. Quantize is a recording function that provides accurate timing by automatically correcting these differences. Setting quantize allows you to record with the sounds accurately synchronized to the closest quarter note, eighth note, sixteenth note, or other setting.

This is especially convenient for creating exact timing in Groove music and other genres.

This feature is also useful in creating rhythm patterns.

12. **Turn the CTRL 3/MFX knob to set the quantization.**
The quantize setting appears in the display.
The meaning of each indication is shown below.
oFF: No quantization. Notes generated by the pads are recorded exactly as pressed.
4: Aligned to the nearest quarter note.
8: Aligned to the nearest eighth note.
8-3: Aligned to the nearest eighth-note triplet.
16: Aligned to the nearest sixteenth note.

13. Press [QUANTIZE], and confirm that the button has turned off.

14. Press [REC].

[REC] changes from a blinking to a steady light, and recording starts.

One measure of a count sound is inserted before recording actually begins; wait for one measure while listening to the metronome beat. At this time, a countdown showing “-4, -3, -2, -1” appears in the display, with each count occurring on the beat.

When the count-in is finished, actual recording then begins, and the measure and beat are indicated in the display.

** No pad played during the count is recorded.*

15. **Press the pads at the time you want them to be recorded.**

During recording, the samples can be played with the pads. You can also switch sample banks by pressing the BANK buttons.

Pressing a pad plays its sample, and the sound is recorded with the timing corrected according to the quantization setting.

If the number of measures indicated in the display exceeds the value set for the pattern length, recording continues automatically after returning to the first measure (Loop Recording).

At this point, the previously recorded samples are played back.

16. **Press the pads for any additional samples you want to record.**

The previously recorded pad performances and the performances for the pads currently pressed are layered and recorded together (overdubbing). When using many overdubbed samples, even with complex performances that cannot be recorded at one time, you can spread out the recording over as many passes you need.

When You Want To Change Quantize During the Recording

- a. Press [QUANTIZE], and confirm that the button has lit.
- b. Turn the CTRL 3/MFX knob to change the quantization setting.
- c. After making the setting, press [QUANTIZE], and confirm that the button has turned off.

The quantize setting is recorded, and the new setting is immediately reflected in the recording.

17. **Press [REC] at the point you want recording to stop.**

The dots blink on the display. Recording ends when this indication stops blinking.



Never turn off the power while the dots are blinking. This may result in corruption not only of the pattern currently being recorded, but may also damage other patterns, as well as the memory card.

Erasing the Data for Mistakes in Performances

You can erase performances of samples recorded by mistake by specifying the sample pads and erasing the data.

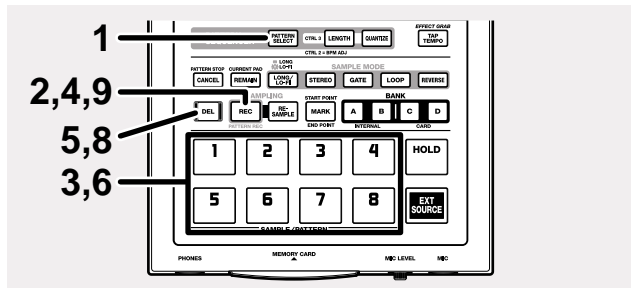

1. Press [PATTERN SELECT], and confirm that the button has lit.
“Ptn” appears in the display.
The pad to which the pattern is assigned blinks.
* *If already lit, there is no need to press the button.*
* *Take care to note that if [PATTERN SELECT] is not lit, the SP-303 will proceed with sampling.*
2. Press [REC], and confirm that the button has lit.
[REC] lights, and the metronome starts sounding.
3. Press the pad for the pattern whose recorded performance you want to erase.
The pressed pad lights, and the other pad lights go out.
[REC] blinks.
4. Press [REC].
[REC] changes from a blinking to a steady light, and recording starts.
The recorded performance is played back.
* *Take care to note that pressing a sample’s pad at this time will result in that performance being recorded.*
5. Press [DEL], and confirm that the button has lit.
“ErS” appears in the display.
6. Press the pad with the sample you want to erase at the time it is to be erased.
The dots in the display blink while the pad is held down, and the performance of that pad is erased.
7. Repeat Step 6 as needed.
8. When you have finished erasing the data, press [DEL].
[DEL] lights go out, and the pattern returns to normal recording mode.
* *Take care to note that pressing a sample’s pad at this time will result in that performance being recorded.*
9. Press [REC].

The dots blink in the display; when the blinking stops, deletion is finished.

NOTE

Never turn off the power while the dots are blinking. This may result in corruption not only of the pattern currently being recorded, but may also damage other patterns as well as the memory card.

Deleting Patterns

Specifying and Deleting a Single Pattern

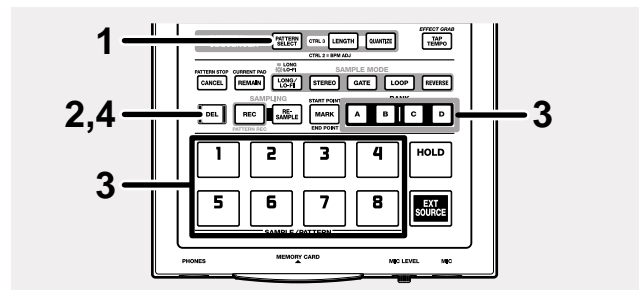

1. Press [PATTERN SELECT], and confirm that the button has lit.
“Ptn” appears in the display.
The pad being recorded blinks.
* *If already lit, there is no need to press the button.*
* *Take care to note that if [PATTERN SELECT] is not lit, the SP-303 will then proceed with deletion of the sample (p. 33).*
2. Press [DEL], and confirm that the button has lit.
“dEL” appears in the display.
* *If there are no patterns assigned to any of the pads, “EMP” appears in the display for several seconds, and you cannot proceed with the deletion.*
3. Press the bank button and pad to specify the bank and pad of the pattern to be deleted.
The selected pad lights up, and [DEL] blinks.
* *If you press a pad to which no pattern is assigned, nothing will happen.*
* *If you decide not to delete, press [CANCEL].*
4. Press [DEL].
[DEL] is lit, and the dots in the display begin to blink.
When the blinking stops, deletion is finished.

NOTE

Never turn off the power while the dots are blinking. This may result in corruption not only of the pattern currently being deleted, but may also damage other patterns as well as the memory card.

Deleting All Patterns Together

You can delete all patterns from the SP-303's internal memory or memory card in one operation.

- * When this procedure is carried out on a memory card, the memory card's backup area (refer to p. 48) is deleted at the same time. So, please check the data carefully before deleting.

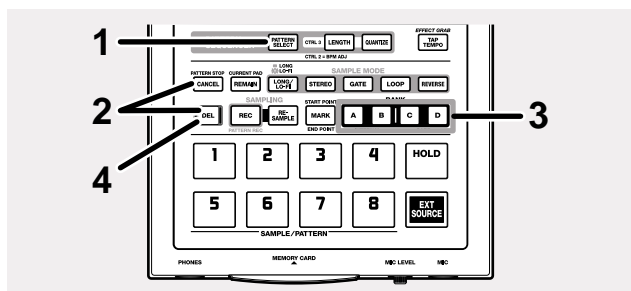

1. Press [PATTERN SELECT], and confirm that the button has lit.
"Ptn" appears in the display.
 - * If already lit, there is no need to press the button.
 - * Take care to note that if [PATTERN SELECT] is not lit, the SP-303 will then proceed with deletion of the sample (p. 34).
2. While holding down [CANCEL], press [DEL].
"dAL" (Delete ALL) appears in the display.
[DEL] lights up, and the bank buttons blink.
3. Select the memory to be cleared.
If deleting the patterns in the internal memory, press BANK [A] or [B]; if deleting the patterns on a memory card, press BANK [C] or [D].
When BANK [A] or [B] is pressed, both [A] and [B] light up. When BANK [C] or [D] is pressed, both [C] and [D] light up.
[DEL] changes to a blinking light.
 - * If no memory card is inserted, then pressing BANK [C] or [D] creates no response.
 - * If you decide not to delete, press [CANCEL].
4. Press [DEL].
[DEL] lights up, and the dots in the display blink. The deletion is complete when the dots stop blinking and remain off.

NOTE

Never turn off the power while the dots are blinking. This may result in corruption not only of the pattern currently being deleted, but may also damage other patterns, as well as the memory card.

Changing the Assignment of Patterns to the Pads

You can change the assignment of patterns to the pads by exchanging the patterns on two different pads.

You can switch between a pad to which a pattern has already been recorded and a pad to which no pattern has been assigned.

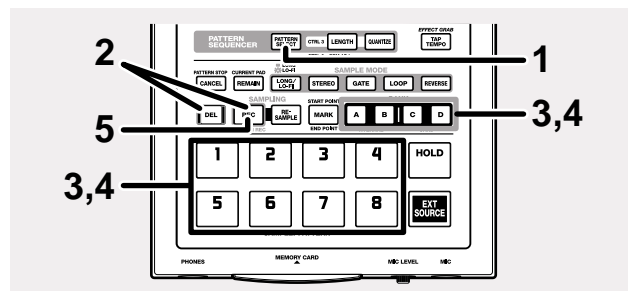

1. Press [PATTERN SELECT], and confirm that the button has lit.
"Ptn" appears in the display.
 - * Take care to note that if [PATTERN SELECT] is not lit, the samples will then be switched (p. 34).
2. While holding down [DEL], press [REC].
[DEL] and [REC] light up, and "CHG" appears in the display.
The pads to which the patterns are assigned then blink.
3. Press the BANK button and pad for one of the patterns to be exchanged.
The pad lights up.
4. Press the BANK button and pad for the other pattern to be exchanged.
The pad lights up, and [REC] blinks.
5. Press [REC].
[DEL] and [REC] light, and the dots in the display blink. The exchange is complete when the dots stop blinking and remain off.
 - * If insufficient free space is available when exchanging patterns between the SP-303's memory and a memory card, "FuL" is displayed, and the exchange cannot be carried out. Note that sufficient memory is needed particularly on the memory card.

NOTE

Never turn off the power while the dots are blinking. This may result in corruption not only of the patterns currently being exchanged, but may also damage other patterns as well as the memory card.

Chapter 6. Using Memory Cards

You can use commercially available SmartMedia cards as memory cards for the SP-303; The 3.3 V type with the capacities of 8 MB to 64 MB can be used.

NOTE

1 MB, 2 MB, and 4 MB SmartMedia cards cannot be used.

MEMO

SmartMedia can be purchased at computer stores and vendors handling digital cameras.

* For details on using SmartMedia, refer to the SmartMedia owner's manual.

Memory Cards

In addition to the sixteen samples of Banks C and D and the sixteen patterns of Pattern Banks C and D, you can also store (save) up to seven sets of the SP-303's own samples and patterns (from internal memory) in the backup area of a memory card.

MEMO

The memory in a card's backup area is shared by Banks C and D and Pattern Banks C and D, so if a large amount of memory is used in saving data for a certain sample or pattern, that portion becomes unavailable for the other data.

* Once this portion is used as a backup area, the possible sampling time will be correspondingly less. If you wish to use long samples, either re-format the card or purchase additional memory cards.

* Saving extended samples in card memory reduces the backup area as well as the recording time available for patterns.

(With the backup area using more memory)

Sampling data	Pattern data	Backup Area	Backup Area
C1-D8	C1-D8	1	2

(With the sampling data using more memory)

Sampling data	Pattern data	Backup Area
C1-D8	C1-D8	1

* In some cases, a SmartMedia card which was used by the SP-303 may no longer be usable by other SmartMedia-compatible devices.

MEMO

The procedures below cannot be carried out when there is no memory card inserted in the SP-303 or if the card is not formatted.

- Recording and erasing of samples and patterns in Banks C and D
- Playback, erasing, and exchanging of samples and patterns in Banks C and D
- Saving and loading of samples and patterns

In addition, if you attempt to carry out one of the following procedures with a write protect sticker affixed to the memory card, "Prt" appears in the display, and you are prevented for carrying out the operation (p. 51).

- Recording and erasing of samples and patterns in Banks C and D
- Changing the settings of samples in Banks C and D
- Erasing and exchanging of samples and patterns in Banks C and D
- Saving of samples and patterns

Inserting a memory card

NOTE

The power of the SP-303 must be turned off before inserting or removing a memory card (SmartMedia). If a memory card is inserted when the power is turned on, the data in the memory card may be destroyed, or the memory card may become unusable.

Making sure that the memory card (SmartMedia) is oriented correctly, insert it all the way into the slot.

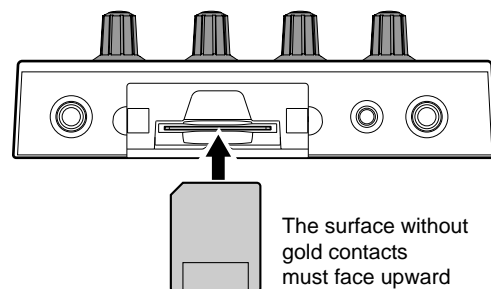

* If you turn on the power with a memory card already inserted, the dots will blink until the memory card is detected. The unit will not operate during this time.

Initializing Memory Cards (Format)

Before the SP-303 can use a newly purchased SmartMedia card or a card which was used by another device, the card must be formatted (initialized) by the SP-303.

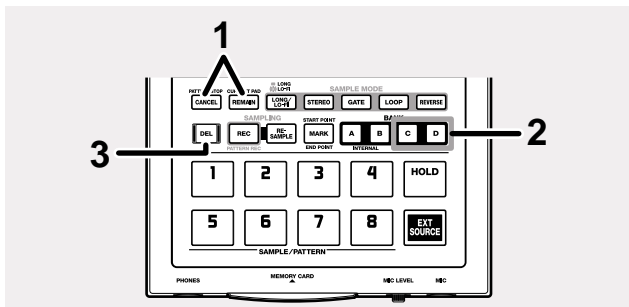

1. **While holding down [CANCEL], press [REMAIN].**
BANK [C] and [D] blinks, and “Fmt” appears in the display.
2. **Press either BANK [C] or [D].**
The BANK [C] and [D] lights remain on, and [DEL] begins to blink.
* *If you decide to cancel the format operation, press [CANCEL].*
3. **Press [DEL].**
[DEL] remains lit, and formatting is executed.
The dots in the display blink while formatting is in progress.
When the dots stop blinking and remain off, formatting is completed.

NOTE

Never turn off the power or remove the memory card while the dots are blinking. This can result in damage to the memory card, and may render the card unusable.

- * *When you format a card, all data that was in the card will be erased.*
- * *In some cases, a SmartMedia card which was formatted by the SP-303 may no longer be usable by other SmartMedia-compatible devices.*

Saving Samples to Memory Cards (Sample Save)

You can save sixteen samples from the SP-303's internal memory (Banks A and B) as one set to the backup area of a memory card.

This operation is called Sample Save.

Data that has been saved in this way cannot be played back until it is once again loaded into the SP-303.

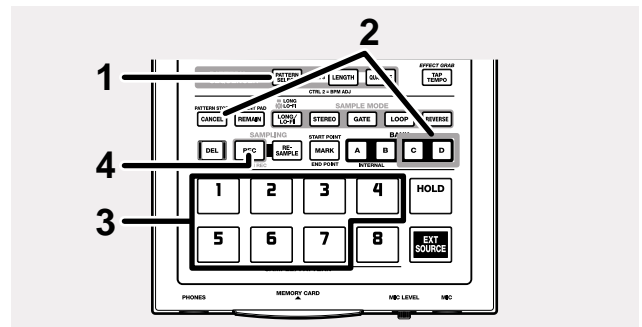

1. **Confirm that [PATTERN SELECT] is not lit.**
If [PATTERN SELECT] is lit, press it so that the button's light goes out.
* *Take care to note that if [PATTERN SELECT] is lit, the SP-303 will then proceed with the Pattern Save operation.*
2. **Hold down [CANCEL] and press either BANK [C] or [D].**
BANK [C] and [D] light up, and the pads corresponding to blank portions of the backup area begin to blink.
3. **Press a pad to specify the number of the area into which you wish to save the data.**
Pressed pads remain lit, and the other pad lights go out.
* *You can select an area number by pressing a pad that is not blinking (excluding a pad [8]). Take care to note here that any data already saved to that area number is overwritten if you continue with the current data to saving.*
* *If you decide to cancel the Save operation, press [CANCEL].*
4. **Press [REC].**
[REC] lights up, and the dots in the display blink.
During the save process, all Pads from [1] through [8] will at first light up, then go out one by one (starting with [1]), indicating the progress of the save.
The saving is completed when the dots stop blinking and remain off.
* *Note that the save process may take up to approximately one minute to complete.*

NOTE

Never turn off the power while the dots are blinking. This may result in damage to the memory card and corruption of data in the internal memory.

Loading Sample from a Memory Card (Sample Load)

You can load the collected data for one set (of sixteen samples) saved to a memory card, replacing the data in the SP-303's internal memory (Sample Banks A and B). This operation is called Sample Load.

NOTE

When this operation is performed, the internal data of the SP-303 will be overwritten. Be sure to make a backup of important data before you do this.

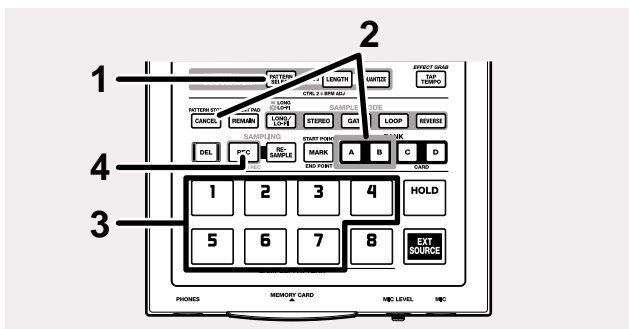

1. Confirm that [PATTERN SELECT] is not lit.
If [PATTERN SELECT] is lit, press it so that the button's light goes out.
** Take care to note that if [PATTERN SELECT] is lit, the SP-303 will then proceed with the Pattern Load operation.*
2. Hold down [CANCEL] and press either BANK [A] or [B].
BANK [A] and [B] light up, and the pads corresponding to the area numbers containing data begin to blink.
** If there are no samples saved to the memory card, then "EMP" appears in the display, and you cannot proceed further with the operation.*
3. Press a pad to specify the card area that you wish to load into internal memory.
Pressed pads remain lit, and [REC] blinks.
** If you decide to cancel the Load operation, press [CANCEL].*
4. Press [REC].
[REC] lights up, and the dots in the display blink.

During the loading process, all Pads from [1] through [8] will at first light up, then go out one by one (starting with [1]), indicating the progress of the load.

The loading is completed when the dots stop blinking and remain off.

- * Note that the loading process may take up to approximately one minute to complete.

NOTE

Never turn off the power while the dots are blinking. This may result in damage to the memory card and corruption of data in the internal memory.

Saving Patterns to Memory Cards (Pattern Save)

You can save sixteen patterns from the SP-303's internal memory (Banks A and B) as one set to the backup area of a memory card.

This operation is called Pattern Save.

Data that has been saved in this way cannot be played back until it is once again loaded into the SP-303.

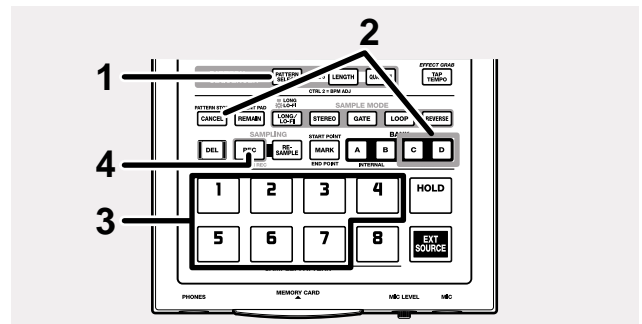

1. Press [PATTERN SELECT], and confirm that the button has lit.
** If already lit, there is no need to press the button.*
** Take care to note that if [PATTERN SELECT] is not lit, the SP-303 will then proceed with the Sample Save operation.*
2. Hold down [CANCEL] and press either BANK [C] or [D].
BANK [C] and [D] light up, and the pads corresponding to blank portions of the backup area begin to blink.
3. Press a pad to specify the number of the area into which you wish to save the data.
Pressed pads remain lit, and the other pad lights go out.
** You can select an area number by pressing a pad that is not blinking (excluding a pad [8]). Take care to note here that any data already saved to that area number is overwritten if you continue with the current data to saving.*

* If you decide to cancel the Save operation, press [CANCEL].

4. Press [REC].

[REC] lights up, and the save is executed.
The dots in the display blink while the save is in progress.
When the dots stop blinking and remain off, the save is completed.



Never turn off the power while the dots are blinking. This may result in corruption of data on the memory card.

Loading Pattern from a Memory Card (Pattern Load)

You can load the collected data for one set (of sixteen patterns) saved to a memory card, replacing the data in the SP-303's internal memory (Pattern Banks A and B). This operation is called Pattern Load.



When this operation is performed, the internal data of the SP-303 will be overwritten. Be sure to make a backup of important data before you do this.

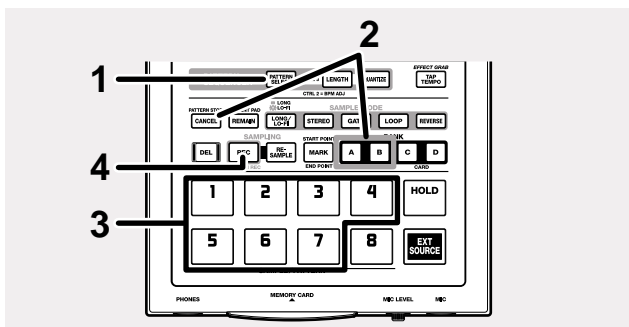

1. Press [PATTERN SELECT], and confirm that the button has lit.

- * If already lit, there is no need to press the button.
- * Take care to note that if [PATTERN SELECT] is not lit, the SP-303 will then proceed with the Sample Load operation.

2. Hold down [CANCEL] and press either BANK [A] or [B].

BANK [A] or [B] light up, and the pads corresponding to the area numbers containing data begin to blink.

- * If there are no patterns saved to the memory card, then "EMP" appears in the display, and you cannot proceed further with the operation.

3. Press a pad to specify the card area that you wish to load into internal memory.

Pressed pads remain lit, and [REC] blinks.

- * If you decide to cancel the Load operation, press [CANCEL].

4. Press [REC].

[REC] lights up, and loading is executed.

The dots in the display blink while loading is in progress. When the dots stop blinking and remain off, loading is completed.



Never turn off the power or remove the memory card while the dots are blinking. This may result in damage to the memory card and corruption of data in the internal memory.

Protecting the Data on Memory Cards (Protect)

Write protect stickers are included with SmartMedia.

These stickers are used to prevent data from accidentally being deleted or overwritten.

Be sure to put these write protect stickers on SmartMedia cards to which important data is saved.

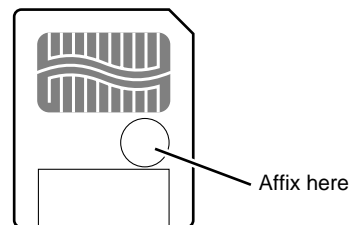

- * You cannot sample or record patterns to a memory card (Banks C and D) that has a write protect sticker affixed to it. (Samples settings cannot be changed as well.) Additionally, you cannot save samples and patterns to the memory card.

Importing Wave Data to the SP-303 From a Computer

You can use SmartMedia cards to import WAVE and AIFF files from a personal computer and transfer them to the SP-303.

MEMO

Copying WAVE/AIFF files to SmartMedia cards requires the purchase of an optional SmartMedia adapter. Refer to the user's guide provided with the SmartMedia adapter when using such an adapter.

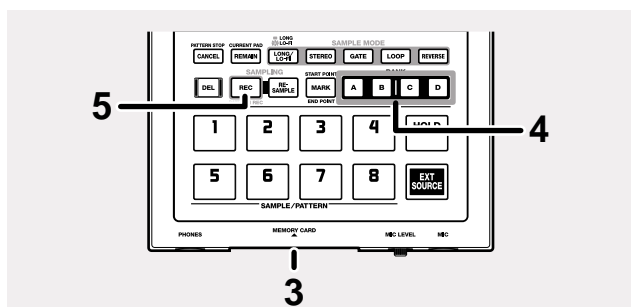

1. **Format the SmartMedia card on the SP-303 (p. 49).**
If not formatted on the SP-303, the card cannot be used for handling data.
2. **Copy WAVE/AIFF files from the computer to the SmartMedia card using the following file names.**

WAVE Files

- SMPL0001.WAV → Loaded to Pad 1
- SMPL0002.WAV → Loaded to Pad 2
- SMPL0003.WAV → Loaded to Pad 3
- SMPL0004.WAV → Loaded to Pad 4
- SMPL0005.WAV → Loaded to Pad 5
- SMPL0006.WAV → Loaded to Pad 6
- SMPL0007.WAV → Loaded to Pad 7
- SMPL0008.WAV → Loaded to Pad 8

AIFF Files

- SMPL0001.AIF → Loaded to Pad 1
- SMPL0002.AIF → Loaded to Pad 2
- SMPL0003.AIF → Loaded to Pad 3
- SMPL0004.AIF → Loaded to Pad 4
- SMPL0005.AIF → Loaded to Pad 5
- SMPL0006.AIF → Loaded to Pad 6
- SMPL0007.AIF → Loaded to Pad 7
- SMPL0008.AIF → Loaded to Pad 8

- * No files with file names other than the those can be loaded.
- * Only WAVE or AIFF files with a sampling frequency of 44.1 kHz can be loaded.
- * You cannot load waves that are shorter than approximately 100 milliseconds.
- * Waves can be loaded until the capacity of the SP-303's internal memory is reached. All wave data or files loaded after the capacity of internal memory has been exceeded are ignored.
- * If both WAVE files and AIFF files are saved to the same SmartMedia card, the AIFF files are disregarded, and only the WAVE files are loaded.

3. **With the SP-303's power turned off, insert a SmartMedia memory card in the memory card slot, then turn the POWER switch to ON.**
“UAU” (WAV) or “AiF” appears in the display, and BANK [A]–[D] blink.
4. **Press any of BANK [A]–[D] to select the load destination bank.**
The pressed bank button remains lit, and [REC] blinks.

NOTE

Here, the samples in the selected bank are overwritten by the loaded WAVE or AIFF files. Be sure to back up any important sample data before proceeding.

5. **Press [REC].**
[REC] lights up, and the dots in the display blink. During the loading process, all Pads from [1] through [8] will at first light up, and the display will indicate “100.” Then, the indicators will go out one by one (starting with [1]), and at the same time the number shown in the display will grow smaller, thus indicating the progress of the load.
The loading is completed when the dots stop blinking and remain off.
- * Note that, depending on the number of files being loaded, the loading process could take as long as ten minutes or more to complete.
 - * To cancel loading, press [CANCEL].

NOTE

Never turn off the power while the dots are blinking. This may result in corruption of data in the internal memory or on the memory card.

Chapter 7. Using the SP-303 With Other MIDI Devices

“MIDI” is short for “Musical Instrument Digital Interface,” a global standard for the exchange of performance data and tone data between devices and instruments.

With MIDI, you can use the SP-303 to play data from a sequencer, keyboard, or other MIDI device.

When using MIDI, use a MIDI cable to connect the MIDI OUT of the MIDI device you are connecting and the SP-303’s MIDI IN connector (refer to “Making Connections” on p. 11).

Additionally, you must set the MIDI device’s Transmit channel and the SP-303’s Receive channel to the same channel.

* For more on the settings for the MIDI device being connected, refer to the owner’s manual for that device.

If you want to restore the SP-303’s MIDI settings to the original factory settings, refer to “Restoring the MIDI Settings to the Factory Settings” (p. 58).

Using the SP-303 With a MIDI Keyboard

At the factory settings, you can just connect a MIDI keyboard to the SP-303 to start playing samples.

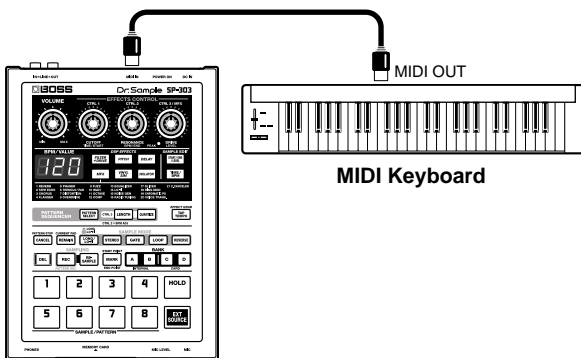

1. Connect the MIDI keyboard’s MIDI OUT connector to the SP-303’s MIDI IN connector with a MIDI cable.

2. Set the MIDI keyboard’s Transmit channel to 1.

For more on how to make this setting, refer to the MIDI keyboard owner’s manual.

* When shipped from the factory, the SP-303’s receive channel is set to 1.

3. When you play the keys on the MIDI keyboard, the SP-303’s samples sound.

The SP-303’s pads correspond to the MIDI keyboard note numbers as shown below.

Pad	EXT SOURCE	A1	A2	A3	A4	A5	A6	A7	A8	
Note		B1	C2	C#2	D2	D#2	E2	F2	F#2	G2
Note Number		35	36	37	38	39	40	41	42	43
Pad		B1	B2	B3	B4	B5	B6	B7	B8	
Note		G#2	A2	A#2	B2	C3	C#3	D3	D#3	
Note Number		44	45	46	47	48	49	50	51	
Pad		C1	C2	C3	C4	C5	C6	C7	C8	
Note		E3	F3	F#3	G3	G#3	A3	A#3	B3	
Note Number		52	53	54	55	56	57	58	59	
Pad		D1	D2	D3	D4	D5	D6	D7	D8	
Note		C4	C#4	D4	D#4	E4	F4	F#4	G4	
Note Number		60	61	62	63	64	65	66	67	

* No sample sounds when any note other than those shown here is played.

How to Change the MIDI Channel

The SP-303’s Receive channel is set to 1 at the factory. If the MIDI keyboard’s Transmit channel cannot be set to 1, then you must change the SP-303’s Receive channel in order to match the MIDI keyboard’s channel.

1. Turn off the power switch of the SP-303.
- 2a. If you wish to select a channel in the range of 1–8, turn the power switch ON while holding down the correspondingly-numbered pad 1–8.
- 2b. If you wish to select a channel in the range of 9–16, turn the power switch ON while holding down [HOLD] together with pad (1–8) that is eight less than the desired channel number.

The MIDI channel will be set to a value of 8 plus the pad number.

Example:

To select channel 3, hold down pad number 3, and turn the power ON.

To select channel 10, hold down [HOLD] together with pad number 2, and turn the power ON.

* The MIDI channel setting is retained even when the power is turned OFF.

Note On Operating With MIDI

If you are using a MIDI device to play samples from the SP-303, you must change the way the external MIDI device's note messages are sent when playing samples using Trigger Playback and Gate Playback.

When Using Gate Playback

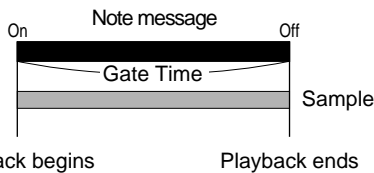

Playback begins Playback ends

When using Gate Playback, where the sound plays only as long as the pad is held down, send a Note On message at the point you want the sound to start playing, and send Note Off at the point you want the sound to stop.

When Using Trigger Playback

When set to One Shot Playback ([LOOP] not lit):

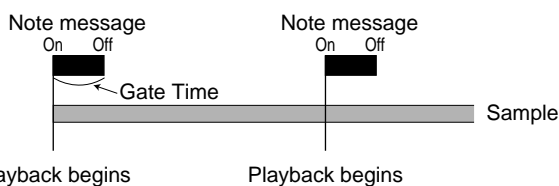

Playback begins Playback begins

Send a note message at the point you want the sound to begin. When the note message is received, the sample is played back, starting from the beginning of the sample. In this case, the interval from the Note On message to the Note Off message can be as short as you want. The sample stops playing when the end of the sample is reached.

When set to Loop Playback ([LOOP] lit):

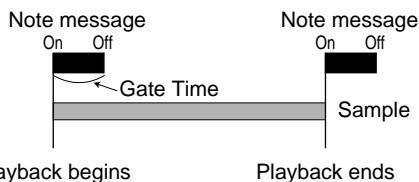

Playback begins Playback ends

Send a note message at the point you want the sound to begin and when you want it to stop. In this case, the interval from the Note On message to the Note Off message can be as short as you want.

* You can change the playback volume on the SP-303 by receiving Note On Velocity.

* The last pad to play becomes the current pad.

- * When continuously playing a sample of a looped phrase along with a MIDI sequencer performance, the rhythm between them may diverge as time passes. In such instances, rather than using Loop Playback, use One Shot Playback and send a Note On message from the MIDI sequencer to the SP-303 at the beginning of each measure (or sampling measure).
- * You cannot change the BPM settings for the SP-303's samples with MIDI clock.

Using the SP-303 With a MIDI Sequencer (Tempo Sync)

Here is an explanation of how to connect a MIDI sequencer to the SP-303 and synchronize the SP-303's patterns with the MIDI sequencer.

Synchronizing the Pattern's Tempo and Start/Stop to the MIDI Sequencer

At the factory settings, you can simply connect a MIDI sequencer to the SP-303, and you use the sequencer to control the start and stop of patterns, as well as the tempo.

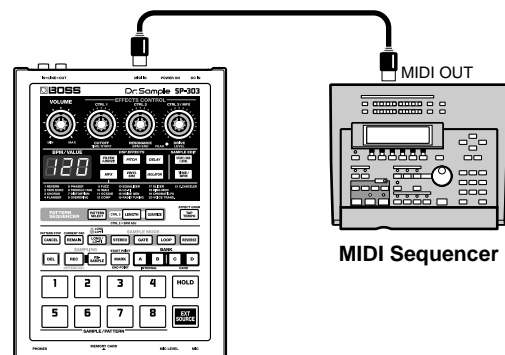

1. Connect the MIDI sequencer's MIDI OUT connector to the SP-303's MIDI IN connector with a MIDI cable.
2. Press [PATTERN SELECT], and confirm that the button has lit.
3. Press one of BANK [A]–[D] to select the bank holding the pattern you want to play.
 - * If there is no memory card inserted in the slot, you will be unable to select Pattern Bank C or D.
4. Hold down [REMAIN] and press the pad for the pattern you want to play (specify the pattern). The pad for the specified pattern lights up.
 - * Take care to note that the pattern will suddenly start playing if you only press the pad without holding down [REMAIN].

5. Start the MIDI sequencer.

The specified pattern begins playing in sync with the MIDI sequencer.

The tempo of the pattern is synchronized to the MIDI sequencer's tempo.

6. When you press the pad that is blinking, the corresponding pattern will be selected.**7. When the MIDI sequencer is stopped, the pattern stops playing.**

- * *If the pattern does not start playing when the MIDI sequencer is started, or if the tempo is not synchronized to the MIDI sequencer, it may be that MIDI clock or Start/Continue/Stop is not being transmitted from the MIDI sequencer. Refer to the MIDI sequencer owner's manual and check the sequencer's settings.*

Synchronizing Only the Pattern Tempo with a MIDI Sequencer

To play the patterns on the SP-303 along with the performance of song data recorded to a MIDI sequencer at whatever timing you decide, layering the two performances, you should set the SP-303 so that Start and Stop messages sent from the MIDI sequencer are ignored.

- 1. Turn off the power switch of the SP-303.**
- 2. Hold down [TIME/BPM] and slide the POWER switch to ON.**

MIDI Sync mode is indicated in the display. In MIDI Sync mode, the SP-303 switches to synchronized operation.

The meaning of each symbol is given below.

Aut (Auto Sync) :

When MIDI Clock is used, it is detected automatically and the tempo is synchronized. Additionally, patterns start and stop according to the MIDI Start, Stop, and Continue messages received.

- * *MIDI Start, Stop, and Continue messages are not received during recording of patterns.*

tMp (Tempo Sync) :

When MIDI Clock is used, it is detected automatically and the tempo is synchronized. However, MIDI Start, Stop, and Continue messages are not received.

oFF (Sync OFF) :

MIDI Clock and MIDI Start, Stop, and Continue messages are not received.

3. Turn the CTRL 1 (TIME) knob to set the MIDI Sync mode to "tMp."

- * *With the factory settings, this is set to "Aut."*

4. Press [TIME/BPM].

The [TIME/BPM] light goes out, and the settings value is recorded.

- * *The value set here remains in memory even after the power is turned off.*

5. Start the MIDI sequencer.

The pattern does not start playing at this time.

6. Press [PATTERN SELECT], and confirm that the button has lit.

- * *Take care to note that if [PATTERN SELECT] is not lit, then a sample will play.*

7. Press one of BANK [A]–[D] to select the bank holding the pattern you want to play.

- * *If there is no memory card inserted in the slot, you will be unable to select Pattern Bank C or D.*

8. Press the pads at the point you want the pattern to play.

The performance of the pattern starts. At this time, the pattern's tempo is synchronized to the MIDI sequencer.

9. Press [CANCEL] at the point you want the pattern to stop playing.

The performance of the pattern stops.

- * *Stopping only the sequencer does not stop the pattern. Be sure to press [CANCEL] to stop the pattern.*

Playing Samples Without Synchronizing the Tempo

If you only want to use the note messages from the MIDI sequencer to play samples on the SP-303, it is easier if you don't synchronize the patterns to the MIDI sequencer.

In such instances, you can use the following procedure to turn off synchronization of the tempo.

- 1. Turn off the power switch of the SP-303.**
- 2. Hold down [TIME/BPM] and slide the POWER switch to ON.**
MIDI Sync mode is indicated in the display.
- 3. Turn the CTRL 1 (TIME) knob to set the MIDI Sync mode to "oFF."**
* *With the factory settings, this is set to "Aut."*

4. Press [TIME/BPM].

The [TIME/BPM] light goes out, and the settings value is recorded.

* *The value set here remains in memory even after the power is turned off.*

5. Start the MIDI sequencer.

The SP-303's samples are played according to the note messages from the MIDI sequencer.

6. Stop the MIDI sequencer at the point that you want the sample to stop playing.

Using the SP-303 as a Rhythm Sound Module

For example, if you want to use the expansion rhythms of one of the SP-303's samples for a GS sound module's rhythm part, take the following procedure.

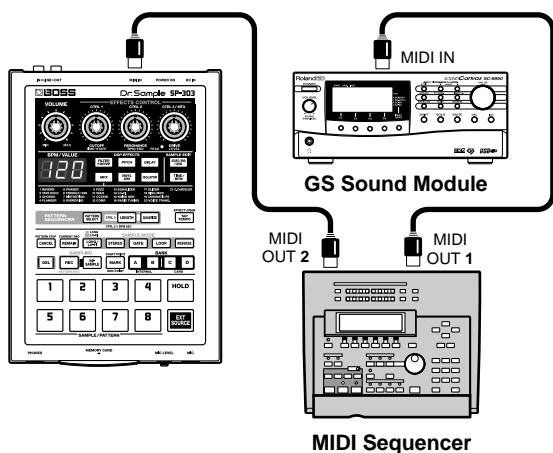

1. Turn the power switch OFF.
2. Hold down [EXT SOURCE] and [HOLD], and slide the POWER switch to ON.

This sets the SP-303's MIDI Receive channel to Channel 10. The rhythm part on GS sound modules and other MIDI devices is ordinarily set to Channel 10, so setting the SP-303's MIDI channel to Channel 10 enables the sample to be played on the same channel as the GS sound module's rhythm part.

Furthermore, set the correspondence between the note numbers and pads as shown below to avoid having the note numbers used for the GS sound module's rhythm part overlap with the SP-303's note numbers.

Pad	EXT SOURCE	A1	A2	A3	A4	A5	A6	A7	A8	
Note		B6	C7	C#7	D7	D#7	E7	F7	F#7	G7
Note Number		95	96	97	98	99	100	101	102	103
Pad		B1	B2	B3	B4	B5	B6	B7	B8	
Note		G#7	A7	A#7	B7	C8	C#8	D8	D#8	
Note Number		104	105	106	107	108	109	110	111	
Pad		C1	C2	C3	C4	C5	C6	C7	C8	
Note		E8	F8	F#8	G8	G#8	A8	A#8	B8	
Note Number		112	113	114	115	116	117	118	119	
Pad		D1	D2	D3	D4	D5	D6	D7	D8	
Note		C9	C#9	D9	D#9	E9	F9	F#9	G9	
Note Number		120	121	122	123	124	125	126	127	

* *This setting is retained even while the SP-303 is turned off.*

Using the SP-303 With a Rhythm Machine

Synchronizing the Performance of the SP-303's Patterns with a Rhythm Machine's Tempo

At the factory settings, you can simply connect a rhythm machine to the SP-303, and use the rhythm machine to control the start and stop of patterns, as well as the tempo.

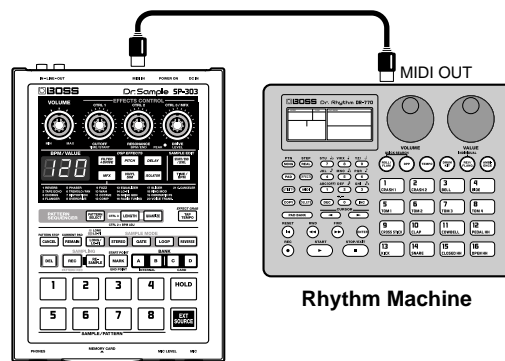

1. Connect the rhythm machine's MIDI OUT connector to the SP-303's MIDI IN connector with a MIDI cable.
2. Press [PATTERN SELECT], and confirm that the button has lit.
3. Press one of BANK [A]–[D] to select the bank holding the pattern you want to play.

* *If there is no memory card inserted in the slot, you will be unable to select Pattern Bank C or D.*

4. Hold down [REMAIN] and press the pad for the pattern you want to play (specify the pattern).

The pad for the specified pattern lights up.

* *Take care to note that the pattern will suddenly start playing if you only press the pad without holding down [REMAIN].*

5. Start the rhythm machine.

The specified pattern begins playing in sync with the rhythm machine. The tempo of the pattern is synchronized to the rhythm machine's tempo.

6. When a pad other than the one that is lit is pressed, the pattern switches.

* If a pad with no pattern assigned to it is pressed, the action is disregarded.

7. When the rhythm machine is stopped, the pattern stops playing.

* If the pattern does not start playing when the rhythm machine is started, or if the tempo is not synchronized to the rhythm machine, it may be that MIDI clock or Start/Continue/Stop is not being transmitted from the rhythm machine. Refer to the rhythm machine owner's manual and check the rhythm machine's settings.

Using the Note Messages from the Rhythm Machine to Play the SP-303's Samples

If you only want to play the SP-303's samples using the note messages from the rhythm machine, it is easier if you don't synchronize the patterns to the rhythm machine.

In addition, on numerous rhythm machines, the MIDI channel is normally set to Channel 10, so you will need to set the SP-303's Receive channel to Channel 10 in order to receive the note messages from the rhythm machine.

1. Connect the rhythm machine's MIDI OUT connector to the SP-303's MIDI IN connector with a MIDI cable.

2. Turn off the power switch of the SP-303.

3. Hold down [TIME/BPM] and slide the POWER switch to ON.

MIDI Sync mode is indicated in the display.

4. Turn the CTRL 1 (TIME) knob to set the MIDI Sync mode to "OFF."

* With the factory settings, this is set to "Aut."

5. Press [TIME/BPM].

The [TIME/BPM] light goes out, and the settings value is recorded.

* This setting is retained even while the SP-303 is turned off.

6. Turn the SP-303's power switch OFF again.

7. Hold down [HOLD] together with pad number 2, and turn the power switch ON.

The Receive channel is set to Channel 10.

* This setting is retained even while the SP-303 is turned off.

* If the rhythm machine's MIDI channel is set to something other than Channel 10, set the SP-303's Receive channel to match that setting. For more on how to make this setting, refer to "How to Change the MIDI Channel" (p. 53).

8. Start the rhythm machine.

The SP-303's samples are played according to the note messages from the rhythm machine.

* Trigger Playback with One Shot Playback is the optimum setting for samples when playing samples using note messages from a rhythm machine.

* In some cases, when a sample is set to Gate Playback, the rhythm machine may play the sample for only a moment and then immediately cut off the sound.

* When a sample is set to Loop Playback, continuous repeated playback of the sample may result in loss of the correct rhythm.

9. Stop the rhythm machine at the point that you want the sample to stop playing.

HINT

With many rhythm machines, the correspondence between rhythms and note numbers is fixed. Therefore, assigning sounds to the SP-303's pads as described below makes it easier to create the rhythm you have in mind.

Bank A	Pad 1	Kick
	Pad 2	Stick/Rim Shot
	Pad 3	Snare 1
	Pad 4	Hand Clap
	Pad 5	Snare 2
	Pad 6	Low Tom 2
	Pad 7	Closed Hi-Hat
	Pad 8	Low Tom 1
Bank B	Pad 1	Pedal Hi-Hat
	Pad 2	Mid Tom 2
	Pad 3	Open Hi-Hat
	Pad 4	Mid Tom 1
	Pad 5	High Tom 2
	Pad 6	Crash Cymbal 1
	Pad 7	High Tom 1
	Pad 8	Ride Cymbal 1

Bank C	Pad 1	Chinese Cymbal
	Pad 2	Ride Cymbal (Bell)
	Pad 3	Tambourine
	Pad 4	Splash Cymbal
	Pad 5	Cowbell
	Pad 6	Crash Cymbal 2
	Pad 7	Vibra-slap
	Pad 8	Ride Cymbal 2
Bank D	Pad 1	High Bongo
	Pad 2	Low Bongo
	Pad 3	Mute High Conga
	Pad 4	Open High Conga
	Pad 5	Low Conga
	Pad 6	High Timbale
	Pad 7	Low Timbale
	Pad 8	Agogo

** Tone assignments for some rhythm machines may differ from those listed above. In such cases, refer to the owner's manual for your rhythm machine and assign the tones according to the rhythm machine's tone assignments.*

Restoring the MIDI Settings to the Factory Settings

To restore the MIDI settings, including the MIDI channel and MIDI Sync mode settings, to the original factory settings, use the following procedure.

1. Turn the power switch OFF.
2. Hold down [EXT SOURCE] and slide the POWER switch to ON.

The MIDI settings are set as shown below.

MIDI Channel: 1

MIDI Sync Mode: Aut (Auto Sync)

Chapter 8. Examples of Using the SP-303

Using Pattern Sequencer to Create a Rhythm Pattern

Now let's create a four-measure backing pattern including rhythm as Pattern 1.

Set up the following samples.

Pad 1:	Kick	Trigger, One Shot
Pad 2:	Snare	Trigger, One Shot
Pad 3:	Hi-Hat	Trigger, One Shot
Pad 4:	Bass Phrase (One measure)	Trigger, One Shot, BPM = 120
Pad 5:	Chord Phrase (One measure)	Trigger, One Shot, BPM = 120
Pad 6:	Scratch Sound	Trigger, One Shot

1. Press [PATTERN SELECT], and confirm that the button has lit.
2. Press [REC], and confirm that the button is blinking.
3. Select the Pattern 1 recording destination.
Press Pad [1], and confirm that the button is blinking.
4. Adjust the metronome volume.
Press [START/END/LEVEL], and confirm that the button has lit, then turn the CTRL 3 (LEVEL) knob to adjust the metronome volume.
5. Set the pattern's tempo to 120, so it matches the BPM of the bass and chord phrases.
Press [TIME/BPM], and confirm that the button has lit, then turn the CTRL 2 (BPM) knob until "120" appears in the display.
6. Set the length of the pattern at four measures.
Press [LENGTH], and confirm that the button has lit, then turn the CTRL 3 knob until "4" appears in the display.
7. Set the quantization to quarter notes.
Press [QUANTIZE], and confirm that the button has lit, then turn the CTRL 3 knob until "4" appears in the display.
8. Press [REC] to start recording.
One measure of a count-in is played before recording starts.
9. Input Pad 1 (Kick) at quarter-note intervals in time with the metronome.

QUANTIZE = 4

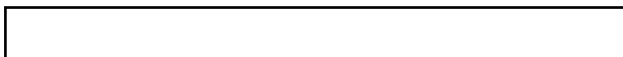

When the four measures are finished, the pattern automatically returns to the beginning. The kick sound just recorded is played back with the correct timing.

10. For the next loop, input Pad 2 (snare) on the second and fourth beats.

QUANTIZE = 4



11. First, set the quantization to eighth notes.
Press [QUANTIZE], and confirm that the button has lit, then turn the CTRL 3 knob until "8" appears in the display.
Press [QUANTIZE] once more, and confirm that the button has turned off.
12. Starting at the beginning of the next pass, input Pad 3 (hi-hat) at eighth-note intervals.
The following time around, confirm that the hi-hat sound is played back with the correct timing.

QUANTIZE = 8

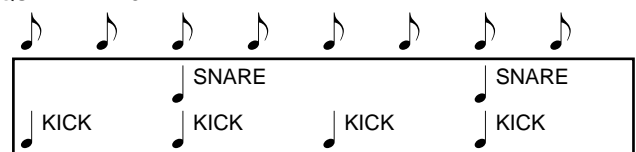

13. Return the quantization setting to quarter-notes.
Press [QUANTIZE], and confirm that the button has lit, then turn the CTRL 3 knob until "4" appears in the display.
Press [QUANTIZE] once more, and confirm that the button has turned off.
14. Starting at the beginning of the next pass, input Pad 4 (bass phrase) at the beginning of every measure.
The bass phrase is played on top of the rhythm already input.

Chapter 8. Examples of Using the SP-303

QUANTIZE = 4

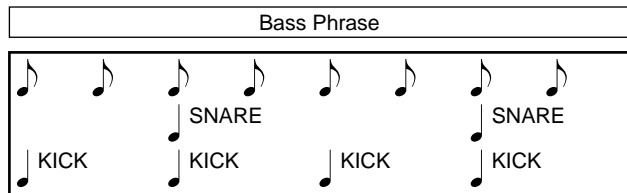

15. Starting at the beginning of the next pass, input Pad 5 (chord phrase) at the beginning of every measure.

QUANTIZE = 4

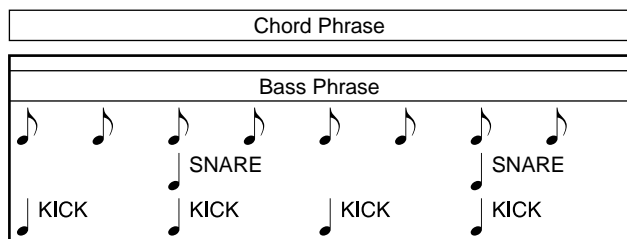

16. Turn off quantization.

Press [QUANTIZE], illuminating the button, then turn the CTRL 3 knob until "oFF" appears in the display.

Press [QUANTIZE] once more, and confirm that the button has turned off.

17. Lastly, input Pad 6 (scratch sound) at whatever timing you like.

The scratch sound is recorded just as played.

QUANTIZE = OFF

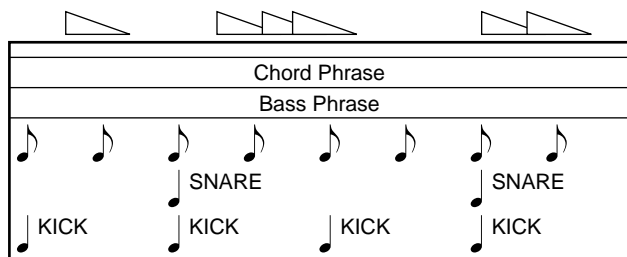

- If you want to delete any mistaken input, press [DEL] while the recording is in progress, lighting the button, then press the pad for the sample you want to delete. The pad's sample is deleted for as long as the pad is held down, and the deletion ends when the pad is released.

ERASE

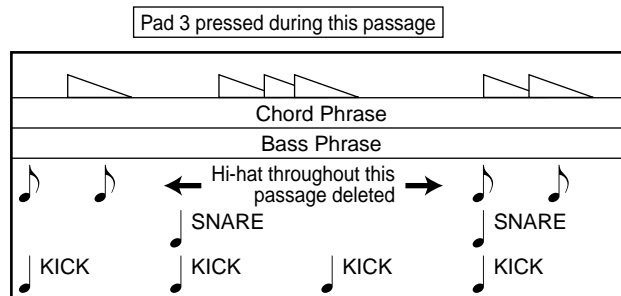

18. When you have finished recording, press [REC], causing the light to go out.

The dots blink in the display for a short while, the process is done.



Never turn off the power while the dots are blinking.

Using the SP-303 with MIDI Devices

When using a MIDI sound module to play multiple parts, you can select any one of the parts and substitute it with the SP-303's performance.

For example, here is how to have the SP-303 play instead of a MIDI sound module's Part 1.

Connections

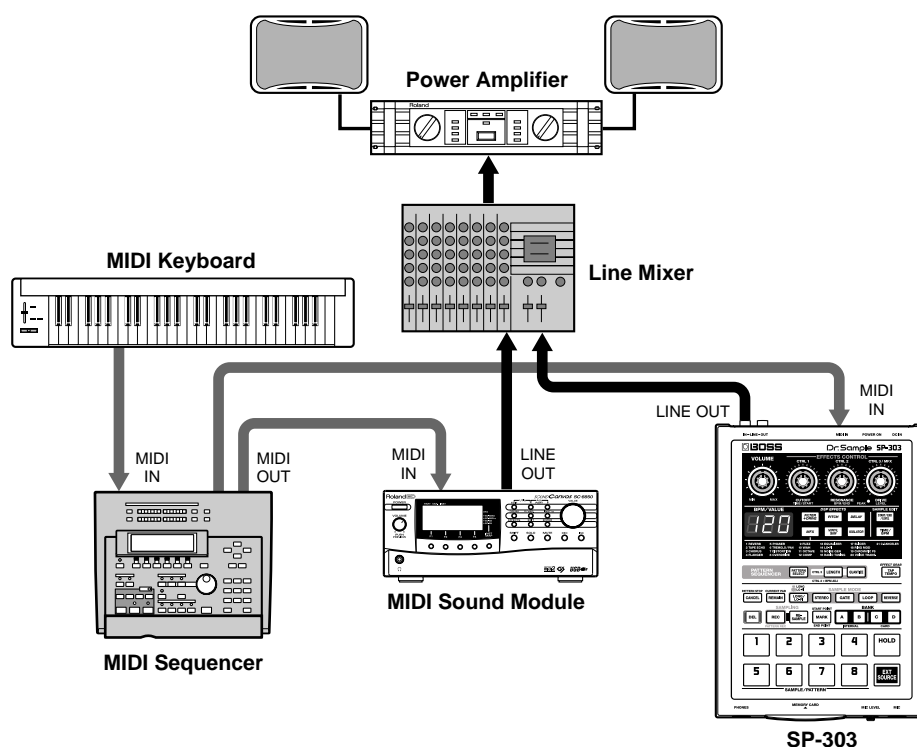

- Set the MIDI THRU on the MIDI sequencer to be ON .
- Set the transmission channel of the MIDI keyboard to Channel 1.
- Mute the sound module's Part 1.
- If the SP-303 is set up for use as a rhythm sound module (p. 56), return the SP-303 to its regular operating status (holding down [EXT SOURCE] and turning the POWER switch to ON returns the SP-303 to normal status).

1. Start recording with the MIDI sequencer and play the MIDI keyboard. The SP-303's sample plays.

The performance of the MIDI keyboard is simultaneously recorded to the sequencer.

2. Stop the recording on the MIDI sequencer.

When the MIDI sequencer is played back, the SP-303's sample is played back just as before.

Using the SP-303 as a rhythm sound module

Here is an introduction to the settings to make when using the SP-303 sample sounds as expansion rhythms for MIDI sound module rhythm parts.

- Set the MIDI THRU on the MIDI sequencer to be ON .
- Set the transmission channel of the MIDI keyboard to Channel 10.

1. Hold down [EXT SOURCE] and [HOLD], and slide the POWER switch to ON.

The SP-303 is set to be used as a rhythm sound module. This enables the SP-303's samples to be played using the same channel as the MIDI sound module's rhythm part.

2. Start recording with the MIDI sequencer, or play the MIDI keyboard.

The MIDI sound module's rhythm part or the SP-303's sample is played in response to the note played.

Chapter 8. Examples of Using the SP-303

The performance from the MIDI keyboard is simultaneously recorded to the MIDI sequencer.

* For more on the correspondence between notes and samples, refer to (p. 56).

3. Stop recording on the MIDI sequencer.

Just as before, when the MIDI sequencer is played back, the MIDI sound module's rhythm part or the SP-303's sample plays.

* To return the SP-303 to its regular operating status, hold down [EXT SOURCE] while switching ON the POWER switch.

Using the SP-303 With a Turntable

Adding Effects to the Turntable Sound

This describes the procedure for adding effects with the SP-303 to the sound from turntables, DJ mixers, and such devices.

Connections

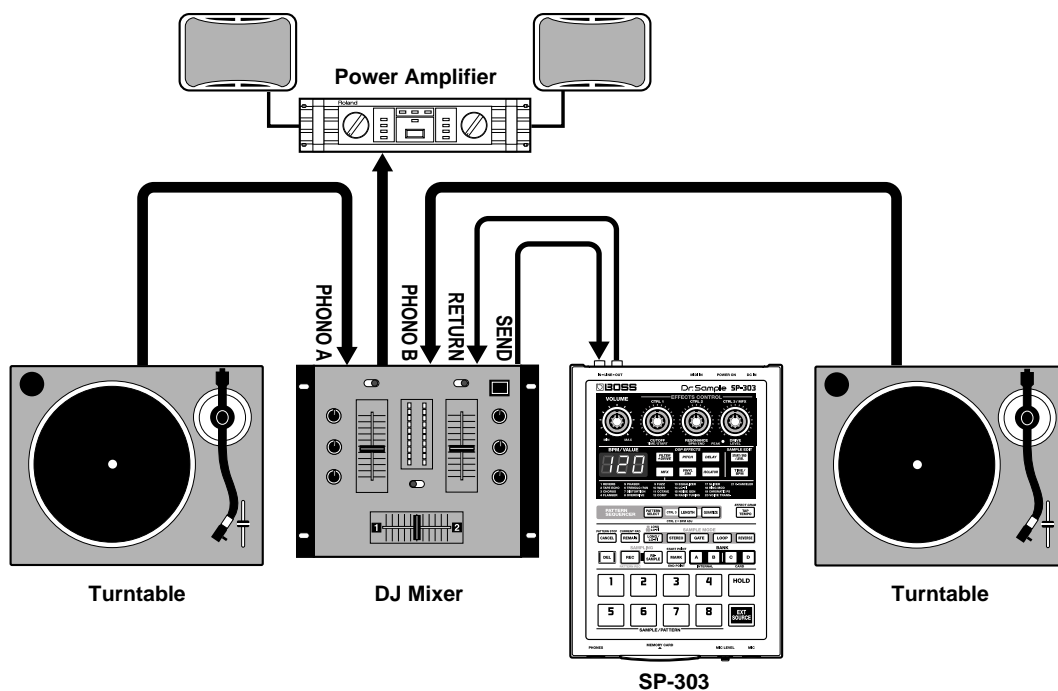

1. Raise the send level of the DJ mixer.
2. Play a record on the turntable.
3. Press the SP-303's [EXT SOURCE], causing the button to light up.
Here, it is convenient to have [GATE] off, as the sound is not cut off even when [EXT SOURCE] is released.
4. Press one of the SP-303's effect buttons, and confirm that the button has lit.

5. Gradually raise the DJ mixer Return level and the SP-303's volume level.
The effect becomes audible.
 6. Turn the CTRL 1-3 knobs to adjust the effect sound.
- * If no effect sound is needed, turn the DJ mixer's Return level down completely.

Playing a Sample Along With the Sound From a Turntable

Here is how to have a sample from the SP-303 play while the sound from a turntable plays simultaneously.

Connections

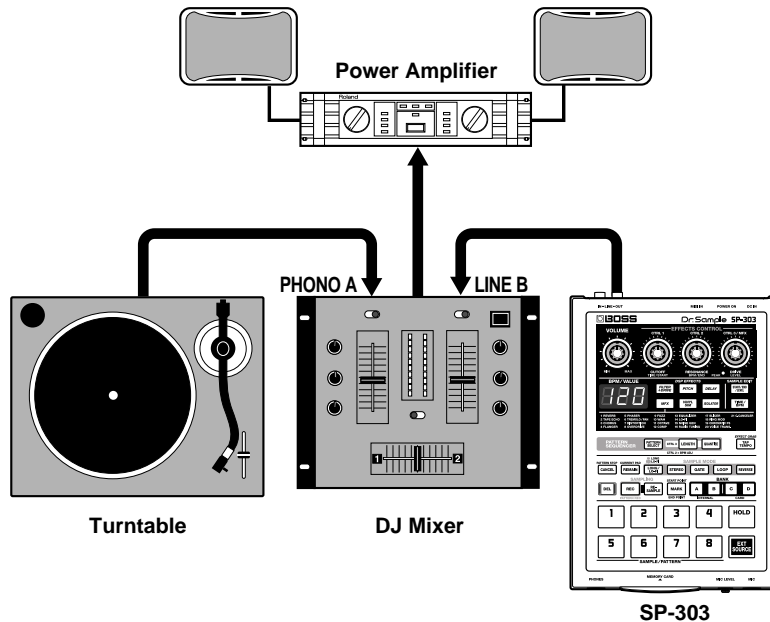

1. Set the DJ mixer's Fader to the SP-303 position.
2. Press the pad on the SP-303.
The sample sound is played. Turn the VOLUME knob to adjust the volume.
3. Set the DJ mixer's Fader near the center.
4. Play a record on the turntable.
5. Press the SP-303 pads along with the record's performance.
The samples play, mixing with the sounds on the record.

Appendices

Chart of Operations

Aim	Operation
Play a sample	Pad [1]–[8]
Play sounds input from an external source	[EXT SOURCE]
Select mono/stereo for the external input	[EXT SOURCE] → [STEREO]
Sampling	[REC] → Pad [1]–[8] → [REC]
Set Auto Sampling	[CANCEL] + [REC] → CTRL 3/MFX (LEVEL) knob → [REC]
Release Auto Sampling	[CANCEL] + [REC] → Turn the CTRL 3/MFX (LEVEL) knob completely to the left → [REC]
Resampling	[RESAMPLE] → CTRL 3/MFX (LEVEL) knob → [REC] → Pad [1]–[8] → [REC] → Pad [1]–[8]
Delete an individual sample	[DEL] → Pad [1]–[8] → [DEL]
Delete all samples	[CANCEL] + [DEL] → BANK [A]–[D] → [DEL]
Set the sampling volume	Pad [1]–[8] → [START/END/LEVEL] → CTRL 3/MFX (LEVEL) knob
Set the Start Point	Pad [1]–[8] → [MARK] → Press Pad [1]–[8] to stop it sounding
Set the End Point	[MARK] + Pad [1]–[8] → [MARK]
Set the Start/End Point	Pad [1]–[8] → [MARK] → [MARK]
Edit the Start/End Point	Pad [1]–[8] → [START/END/LEVEL] → CTRL 1 (START) knob / CTRL 2 (END) knob
Set Time Modify	Pad [1]–[8] → [TIME/BPM] → CTRL 1 (TIME) knob
Exchange samples between pads	[DEL] + [REC] → Specify exchange-source pad → Specify exchange-destination pad → [REC]
Sample Save	[CANCEL] + BANK [C] or [D] → Press a pad ([1]–[7]) to specify the number of the area → [REC]
Sample Load	[CANCEL] + BANK [A] or [B] → Press a pad ([1]–[7]) to specify the number of the area → [REC]
Display available sampling time	[REMAIN]
Select the MFX type	Hold down [MFX] and turn the CTRL 3/MFX knob
Specify the sample to which to apply effects	[REMAIN] + Pad [1]–[8]
Apply effects to all samples	[REMAIN] + lit Effect button
Effect Grab	[TAP TEMPO] + Effect button
Play back a pattern	[PATTERN SELECT] → Pad [1]–[8]
Stop a pattern (1)	[CANCEL]
Stop a pattern (2)	[PATTERN SELECT] → Press the pattern's pad during playback
Record a pattern	[PATTERN SELECT] → [REC] → Pad [1]–[8] → [REC]
Set the pattern tempo (1)	[PATTERN SELECT] → [TIME/BPM] → CTRL 2 (BPM) knob
Set the pattern tempo (2)	[PATTERN SELECT] → Tap [TAP TEMPO] four times
Set Quantize	Press [QUANTIZE] during recording of the pattern or while in recording standby → CTRL 3/MFX knob
Set the pattern length	Press [LENGTH] during recording of the pattern or while in recording standby → CTRL 3/MFX knob
Set the metronome volume	Press [START/END/LEVEL] during recording of the pattern or while in recording standby → CTRL 3/MFX (LEVEL) knob
Erase performance data	Press [DEL] during recording of the pattern → Pad [1]–[8]
Exchange patterns between pads	[PATTERN SELECT] → [DEL] + [REC] → Pad [1]–[8] → Pad [1]–[8] → [REC]
Delete an individual pattern	[PATTERN SELECT] → [DEL] → Pad [1]–[8] → [DEL]

Delete all patterns	[PATTERN SELECT] → [CANCEL] + [DEL] → BANK [A]–[D] → [DEL]
Pattern Save	[PATTERN SELECT] → [CANCEL] + BANK [C] or [D] → Press a pad ([1]–[7]) to specify the number of the area → [REC]
Pattern Load	[PATTERN SELECT] → [CANCEL] + BANK [A] or [B] → Press a pad ([1]–[7]) to specify the number of the area → [REC]
Set the MIDI channel	Channel 1–8: Pad [1]–[8] + Power On Channel 9–16: [HOLD] + Pad [1]–[8] + Power On
Set MIDI Sync mode	[TIME/BPM] + Power On → CTRL 1 (TIME) knob → [TIME/BPM]
Make the settings for a rhythm sound module	[EXT SOURCE] + [HOLD] + Power On
Initialize MIDI settings	[EXT SOURCE] + Power On
Initialize the SP-303's memory	[CANCEL] + [DEL] + [REMAIN] + Power On
Remove the SP-303's memory protection	[CANCEL] + Power On
Protect the SP-303's memory	[REMAIN] + Power On
Format a memory card	[CANCEL] + [REMAIN] → BANK [C] or [D] → [DEL]

Troubleshooting

If the SP-303 does not function as you expect, please check the following points before assuming that a malfunction has occurred. If this does not resolve the problem, contact a nearby Roland service center or your dealer.

Problems With the Sound

■ No Sound/Low Volume

- Is the power to SP-303 and connected devices turned on?
- Are the SP-303 and external devices connected properly?
 - ➔ Check the connections (p. 11).
- Is there a short in any audio cable?
- Could you be using an audio cable containing a resistor?
 - ➔ Use only connection cables (such as one in the Roland PCS Series) that do not add resistance.
- Is the volume of your connected amp or mixer turned down?
 - ➔ Adjust to the proper levels.
- Is the SP-303's volume turned down?
 - ➔ Adjust to the proper level.
- If you are using a memory card, is the memory card inserted correctly?
 - ➔ Remove the memory card, and then reinsert it, making sure it is seated securely in the slot (p. 48).
- If you are attempting to play a sample, is the sample's pad lit? (p. 13)
 - ➔ A sample can be played when the relevant pad has been pressed and is illuminated. If you've pressed a pad, and it didn't light, that means that no sample has been assigned to that pad yet. First, sample a sound for the pad (p. 16, 28, 29).

■ No Sound For a Specific Sample

- Is the sample's level turned down?
 - ➔ Adjust the sample's level (p. 38).
- Is the effect level turned down?
 - ➔ With some effects, you can adjust the level with the control knobs. For more on which knobs are used for each effect, refer to p. 24.

■ No Sound/Low Volume From External Input

- Is [EXT SOURCE] lit?
 - ➔ To play sounds input from an external source, you must press [EXT SOURCE] and illuminate the pad.
- Is the external input level setting turned down?
 - ➔ Adjust the external input level (p. 20).
- Is the volume of the device connected to LINE IN turned down?
 - ➔ Adjust to the proper level.
- Are the audio cables properly connected?
 - ➔ Check the connections (p. 11).
- Is there a short in any audio cable?
- Could you be using an audio cable containing a resistor?
 - ➔ Use only connection cables (such as one in the Roland PCS Series) that do not add resistance.

■ External Input Sound Not in Stereo/Mono

- When [EXT SOURCE] is pressed and lit, is [STEREO] lighted or not?
 - ➔ If [STEREO] is lit, then the sound is in stereo; if not lit, the sound is in mono. If the setting is not the one you want, press [STEREO], illuminating/extinguishing the light as needed to achieve the desired setting.

■ No Sound/Low Volume From Mic

- Is the mic cable properly connected?
 - ➔ Check the connection (p. 11).
- Is there a short in the mic cable?
- Is MIC LEVEL turned down?
 - ➔ Turn the MIC LEVEL knob to adjust to the appropriate level (p. 9).

■ Cannot Sample

- Could insufficient memory be the problem?
 - ➔ “FuL” is displayed if you try to sample when there is not enough available memory. Delete unneeded samples to free up more memory (p. 33, 34).
- If attempting to sample to a memory card, is the memory card inserted correctly?
 - ➔ Remove the memory card, and then reinsert it, making sure it is seated securely in the slot (p. 48).
- Do all of the pads have samples assigned to them?
 - ➔ You cannot sample when there are no free pads. Delete unneeded samples to free up one or more pads (p. 33, 34).
- Is [PATTERN SELECT] lit?
 - ➔ You cannot sample when [PATTERN SELECT] is lit, since the unit has then entered the pattern selection mode. Press [PATTERN SELECT] to turn off the button's light.
- Is [DEL] lit or blinking?
 - ➔ [DEL] is lit or blinking during deletion of samples; you cannot sample at this time.

■ Sampled Sound Is Very Noisy or Distorted

- Is the input level correct?
 - ➔ Sampled sounds may be distorted when the input level is set too high. Conversely, setting the level too low may result in noticeable noise. Set the level so that the PEAK indicator blinks occasionally (p. 16, 28, 30).
- Are the appropriate effect settings being used?
 - ➔ Some effects raise the level above that of the original sample, or have the effect of distorting the sound itself. Other effects emphasize noise.
First turn the effects off to check whether or not there is noise or distortion in the sample itself, then change the effect settings to get the desired result.
- Are you playing more than one complex sample at the same time?
 - ➔ Even when the level of each individual sample is right, playing multiple samples simultaneously can raise the total level and cause distortion. Lower the level of each sample to eliminate the distortion.

Problems With the SP-303's Memory

■ Data Cannot Be Saved Correctly to the SP-303's Memory

- One possibility is that the power was turned off while data was being written to the internal memory (display blinking). Lost data cannot be recovered.
 - ➔ If this indeed is the problem, it may be that all of the data in the SP-303's internal memory has been corrupted. Continued use of the unit in this state may result in further malfunction; initialize the SP-303's memory (p. 68).
- * *All data in the SP-303's memory is lost when the initialization is carried out.*

Problems With Memory Cards

■ Data Cannot Be Saved Correctly to Memory Cards

- One possibility is that the power was turned off while data was being written to the memory card (display blinking). Lost data cannot be recovered.
 - ➔ If this indeed is the problem, it may be that all of the data on the memory card has been corrupted. Continued use in this state may result in further problems; reformat the memory card (p. 49).
- * *All data on the memory card is lost when the card is formatted.*

■ Memory Card Not Recognized Even When Inserted

■ Memory Card Data Cannot Be Selected

- Is the memory card inserted correctly?
 - ➔ Remove the memory card, and then reinsert it, making sure it is seated securely in the slot (p. 48).
- Are you using the correct type of memory card?
 - ➔ Use only 8 MB–64 MB SmartMedia memory cards. Other cards cannot be used.
- Has the memory card been formatted correctly?
 - ➔ The SP-303 is only able to use memory cards formatted on the SP-303. If necessary, format the memory card (p. 49).

Problems With MIDI/Synchronization

■ Cannot Play Samples Using External MIDI Device

- Is the power to the external MIDI device turned on?
- Is the MIDI cable properly connected?
- ➔ Check the connections (p. 11).
- Is there a short in the MIDI cable?
- Are the MIDI channels matched?
- ➔ Match the SP-303's and the external MIDI device's MIDI channels (p. 53).
- Is the external MIDI device set to transmit Note messages?
- ➔ Check the external MIDI device settings.

■ Pattern Sequencer Not Synchronized to the External Midi Device Tempo

- Is Pattern Sequencer correctly set for synchronization?
- ➔ Check the settings (p. 54).
- Is the external MIDI device set to transmit MIDI Clock?
- ➔ Some devices include a setting for turning the transmission of MIDI Clock on and off. In addition, certain external rhythm machines and sequencers only send MIDI Clock when the device is playing back.
- Is the external MIDI device's tempo set beyond the tempo range to which the SP-303 can be synchronized?
- ➔ The SP-303 can be synchronized to tempos in the range of 40–200. Synchronization beyond this range cannot be assured.

Initializing the SP-303's Memory

Initialize the SP-303's internal memory.

NOTE

All sample and pattern data in internal memory will be erased as soon as this procedure is carried out.

- * *Be aware that the factory-supplied samples and patterns cannot be restored.*
- * *You cannot initialize the internal memory while the SP-303's memory protection is turned on (while "Prt" is displayed). For instructions on how to remove the protection, refer to p. 16).*

1. While holding down [CANCEL], [REMAIN], and [DEL], turn on the POWER switch.

"ini" appears in the display, and [REC] blink.

- * *To cancel, simply turn off the power without making any changes.*

2. If you want to proceed with the initialization, press [REC].

[REC] lights up, and the dots in the display blink.

During the initialization process, all Pads from [1] through [8] will at first light up, then go out one by one (starting with [1]), indicating the progress of the initialization.

When the initialization has been completed, [REC] lights go out, and the unit will be placed in its normal power-up default status (p. 12).

- * *Note that the initialization process may take up to approximately one minute or longer to complete.*
- * *Memory protection remains off after the initialization.*

Message List



Data Error

- The sample data is corrupted.
After pressing [CANCEL] to clear the message from the display, delete all the samples together (p. 34).
** Corrupted samples cannot be restored.*
- Pattern data is corrupted. After pressing [CANCEL] to clear the message from the display, delete all the patterns together (p. 47).
** Corrupted patterns cannot be restored.*
- MIDI settings are corrupted.
Simultaneously hold down [EXT SOURCE] while you switch on the power to restore the MIDI settings to their original factory settings (p. 58).
- Data in the SP-303's internal memory is corrupted.
Initialize the internal memory (p. 68).
- Writing data to or reading data from the memory card failed.
The memory card must be a SmartMedia card of from 8 through 64 MB. And, you need to make sure that the card has been inserted securely in the memory card slot.
- Data on the memory card is corrupted.
Reformat the card on the SP-303 (p. 49).
** Data on memory cards cannot be recovered.*
- The memory card is damaged.
Obtain a new memory card.



Memory Full

- The current sample is in excess of available memory. To allow further sampling, delete unneeded samples to free up memory (p. 33, 34). Alternatively, use a new memory card.
- The pattern being recorded is in excess of available memory.
To allow further sampling, delete unneeded patterns to free up memory (p. 46, 47). Alternatively, use a new memory card.
- Memory reached capacity during import of .WAV/AIFF file.
No more data can be imported.



Data Empty

- When deleting a sample, all pads with no sample assigned to it was specified.
- When deleting a pattern, all pads with no pattern assigned to it was specified.
- You have attempted to load data from a memory card onto which no data has been saved.



Format

- Formats the memory card (p. 49).



Resampling Level

- Adjusts the resampling level (p. 32).
By using the CTRL 3 (LEVEL) knob, you can adjust the level of the sound being resampled.



Recording

- Now sampling is proceeded (p. 28, 29).
- Now resampling is proceeded (p. 32).
- Recording of pattern is in progress (p. 44).



Exchange

- Samples or patterns on two pads are exchanged (p. 34, 47).



Delete

- One sample or pattern is deleted (p. 33, 46).



Delete All

- All samples or patterns are deleted in a single group (p. 34, 47).



Protected

- Internal memory protection is on; samples and patterns cannot be recorded or deleted. Turn the Protect switch off. (p. 16)
- A write protect sticker has been affixed to this memory card; you cannot sample, record or erase patterns, nor save anything onto it. Also, you will not be able to format the card.

Peel off the write protect sticker (p. 51).



Truncate

- The sample is undergoing the Truncate operation (p. 41).



Erase

- Pattern data is being erased (p. 46).



Pattern

- Playback, recording, erasing, or saving or loading, or some other operation involving the pattern is in progress.



Initialize

- Initialization of the SP-303's memory is in progress (p. 68).



Ready

- The SP-303 is ready for the input of the input signal in Auto Sampling (p. 31).



Edit

- In the process of making settings for a sample's start/end points, volume, tempo, or playback time (p. 38–42).



Import .WAV

- Memory card containing WAVE files is inserted. WAVE files can be loaded (p. 52).



Import AIFF

- Memory card containing AIFF files is inserted. AIFF files can be loaded (p. 52).



Sample Save

- Sample being saved (p. 49).



Sample Load

- Sample being loaded (p. 50).



Pattern Save

- Pattern being saved (p. 50).



Pattern Load

- Pattern being loaded (p. 51).

Dr. Sample
Model SP-303

MIDI Implementation Chart

Date :Jan. 10, 2001
Version : 1.00

Function...	Transmitted	Recognized	Remarks
Basic Default Channel Changed	X X	1-16 1-16	Memorized
Mode Default Messages Altered	X X *****	Mode 3 X	
Note Number : True Voice	X *****	35-67	Can be changed 95-127
Velocity Note ON Note OFF	X X	O X	
After Touch Key's Ch's	X X	X X	
Pitch Bend	X	X	
Control Change 0-119	X	X	
Prog Change : True #	X *****	X	
System Exclusive	X	X	
System Common : Song Pos : Song Sel : Tune	X X X	O X X	*1
System Real Time : Clock : Command	X X	O O	*1 *1
Aux Message : All sound off : Local ON/OFF : All Notes OFF : Active Sense : Reset	X X X X X	O X X X X	
Notes	<p>* 1 Can be set to O or X.</p> <p>A separate publication titled "MIDI Implementation" is also available. It provides complete details concerning the way MIDI has been implemented on this unit. If you should require this publication (such as when you intend to carry out byte-level programming), please contact the nearest Roland Service Center or authorized Roland distributor.</p>		

Mode 1 : OMNI ON, POLY Mode 2 : OMNI ON, MONO
Mode 3 : OMNI OFF, POLY Mode 4 : OMNI OFF, MONO

O : Yes
X : No

Specifications

SP-303: Dr. Sample

● Maximum Polyphony

8 voices

● Internal Memory

Samples: 16 (8 samples x 2 banks)

Patterns: 16 (8 patterns x 2 banks)

● Memory Card (SmartMedia)

Samples: 16 (8 samples x 2 banks)

Backup: 112 (2 banks x 7 sets)

Patterns: 16 (8 samples x 2 banks)

Backup: 112 (2 banks x 7 sets)

* Only 8 MB to 64 MB SmartMedia with a power-source voltage of 3.3 V can be used.

● Maximum Sampling Time

Internal Memory (Times Approximate)

STANDARD	LONG	LO-FI
31 seconds	63 seconds	3 minutes 10 seconds

Memory Cards (Times Approximate)

Capacity	STANDARD	LONG	LO-FI
8 MB	4 minutes	8 minutes	25 minutes
16 MB	8 minutes	16 minutes	50 minutes
32 MB	16 minutes	33 minutes	101 minutes
64 MB	33 minutes	66 minutes	202 minutes

● Sampling Frequency

STANDARD: 44.1 kHz

LONG: 22.05 kHz

LO-FI 11.025 kHz

● Pattern Sequencer

Maximum Note Storage

Internal Memory: Approx. 7,500 notes

Memory Card (SmartMedia): Approx. 7,500 notes

Resolution: 96 ticks per quarter note

Pattern Length: 1–99 measures

● Effects

26 types

● Signal Processing

A/D Conversion: 20 bit

D/A Conversion: 20 bit

● Nominal Input Level

Input (mic): -40– +4 dBu

Input (line): -10 dBu

● Input Impedance

23 k Ω (line)

2 k Ω (mic)

● Nominal Output Level

Output (line): -10 dBu

● Output Impedance

2 k Ω

● Display

7 segments, 3 characters (LED)

● Connectors

LINE INPUT Jacks (L, R)

LINE OUTPUT Jacks (L, R)

Headphone (PHONES) Jack (Stereo 1/4 inch phone type)

MIC Jack

MIDI IN Connector

AC Adaptor Jack

Memory Card Slot

● Power Supply

AC Adaptor

120/230 V: Roland ACI-Series

230 (UK)/240 V: Roland ACB-Series

● Current Draw

1000 mA

● Dimensions

170 (W) x 241 (D) x 67 (H) mm

6-3/4 (W) x 9-1/2 (D) x 2-11/16 (H) inches

● Weights

850 g / 1 lb 14 oz (excluding AC adaptor)

● Accessories

AC Adaptor

(120/230 V: Roland ACI-Series, 230 (UK)/240 V: Roland ACB-Series)

Owner's Manual

Roland Service (information sheet)

* 0 dBu = 0.775 Vrms



In the interest of product improvement, the specifications and/or appearance of this unit are subject to change without prior notice.

Index

- A**
AiF 52, 70
AIFF File 52
Auto Sampling 31
- B**
Backup Area 48
BPM 15, 30, 41
- C**
CD/MD 29
CHG 34, 47, 69
Clear 34, 47
CURRENT PAD 22
Current Pad 18
- D**
dAL 34, 47, 69
dEL 17, 33, 46, 69
Delay 14, 21
Delete 17, 33–34, 41, 47
Demo Pattern 15
Dots 12
- E**
Edt 70
Effect 14, 21–22, 24
EFFECT GRAB 22
Effects Buttons 22
EMP 33, 69
End Point 30, 38–40
Erase 46
Err 69
ErS 46, 70
Exchange 34, 47
EXT SOURCE Pad 19
- F**
Filter + Overdrive 14, 21
FMt 29, 49, 69
Format 29, 49
FuL 16, 34, 47, 69
- G**
Gate Playback 36, 54
- H**
Hold 19
- I**
ini 68, 70
Initialize 49, 68
Internal Memory 27, 68
Isolator 14, 21
- L**
LEV 32, 69
Load 50–51
LO-FI 27
- Lo-Fi Sampling 27
LONG 27
Loop Playback 36
Loop Recording 44
- M**
Memory Card 27, 29, 48
MFX 14, 21–22, 25
Microphone 28
MIDI 53
MIDI Channel 53
Multi-Effects 14
- N**
Note Number 53, 56
- O**
oFF 42
One Shot Playback 36
Overdubbing 44
- P**
P.Ld 70
P.SV 70
Pattern 15, 43, 48, 50–51
Pattern Bank 15, 43
Pattern Load 51
Pattern Save 50
PEAK Indicator 16, 20, 28, 30
Pitch Shifter 14, 21
Polyphony 18
Protect 16, 51, 68
Prt 16, 68, 70
Ptn 15, 42–43, 46–47, 70
- Q**
Quantize 45
- R**
rdY 32, 70
rEC 32, 69
Receive Channel 53
Recording the Pattern 44
Resampling 32
Reverse Playback 37
Rhythm Machine 56
- S**
S.Ld 70
S.SV 70
Sample 13, 18, 21, 48–50
Sample Bank 13, 18
Sample Load 50
Sample Save 49
Sampling 16, 27–30
Sampling Grade 27
Save 48–50
SmartMedia 48
STANDARD 27

Start Point	38-40
Stereo Sampling	27
Synchronize	54-56

T

Tempo	15, 30, 41
Tempo Sync	54
Time Modify	42
trC	41, 70
Trigger Playback	36, 54
Truncating	41

U

UAU	52, 70
-----------	--------

V

Vinyl Simulator	14, 21
Volume	38

W

WAVE File	52
Write Protect Sticker	51

For the U.K.

IMPORTANT: THE WIRES IN THIS MAINS LEAD ARE COLOURED IN ACCORDANCE WITH THE FOLLOWING CODE.

BLUE: NEUTRAL
BROWN: LIVE

As the colours of the wires in the mains lead of this apparatus may not correspond with the coloured markings identifying the terminals in your plug, proceed as follows:

The wire which is coloured BLUE must be connected to the terminal which is marked with the letter N or coloured BLACK.

The wire which is coloured BROWN must be connected to the terminal which is marked with the letter L or coloured RED.

Under no circumstances must either of the above wires be connected to the earth terminal of a three pin plug.

For EU Countries



This product complies with the requirements of European Directive 89/336/EEC.

For the USA

FEDERAL COMMUNICATIONS COMMISSION RADIO FREQUENCY INTERFERENCE STATEMENT

This equipment has been tested and found to comply with the limits for a Class B digital device, pursuant to Part 15 of the FCC Rules. These limits are designed to provide reasonable protection against harmful interference in a residential installation. This equipment generates, uses, and can radiate radio frequency energy and, if not installed and used in accordance with the instructions, may cause harmful interference to radio communications. However, there is no guarantee that interference will not occur in a particular installation. If this equipment does cause harmful interference to radio or television reception, which can be determined by turning the equipment off and on, the user is encouraged to try to correct the interference by one or more of the following measures:

- Reorient or relocate the receiving antenna.
- Increase the separation between the equipment and receiver.
- Connect the equipment into an outlet on a circuit different from that to which the receiver is connected.
- Consult the dealer or an experienced radio/TV technician for help.

This device complies with Part 15 of the FCC Rules. Operation is subject to the following two conditions:

- (1) This device may not cause harmful interference, and
- (2) This device must accept any interference received, including interference that may cause undesired operation.

Unauthorized changes or modification to this system can void the users authority to operate this equipment.
This equipment requires shielded interface cables in order to meet FCC class B Limit.

For Canada

NOTICE

This Class B digital apparatus meets all requirements of the Canadian Interference-Causing Equipment Regulations.

AVIS

Cet appareil numérique de la classe B respecte toutes les exigences du Règlement sur le matériel brouilleur du Canada.

